

K:\0853061\PLAN\CR100.dwg, CR100, 9/27/2018 11:57:25 AM

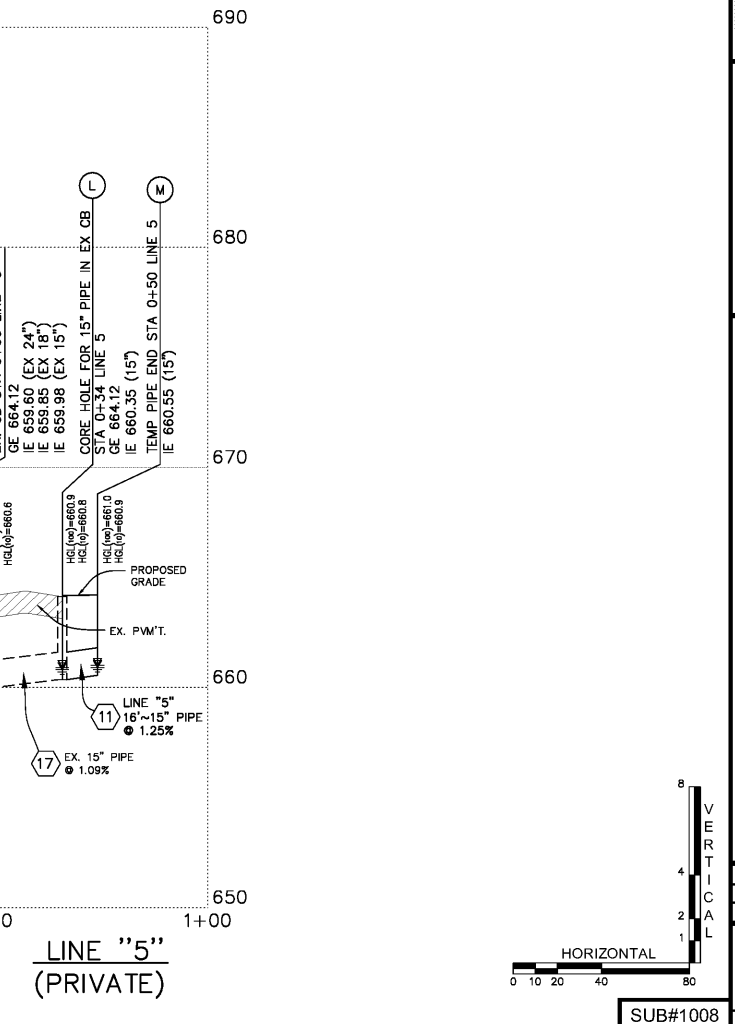

Order Plans @ WWW.AJOnline.com

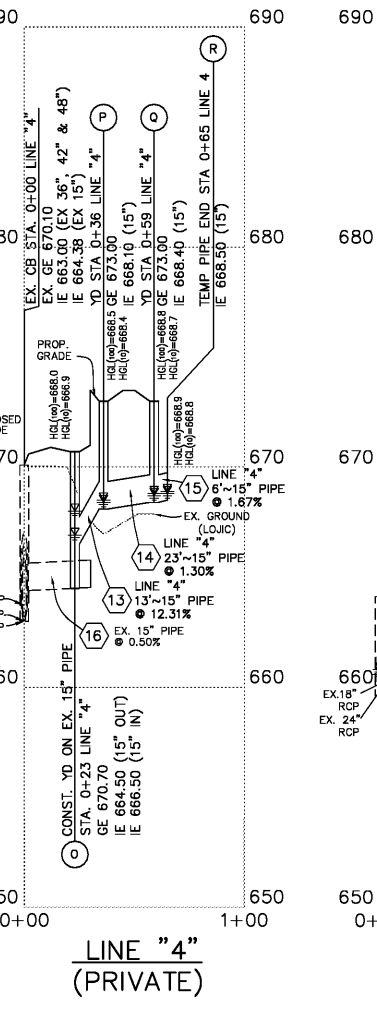
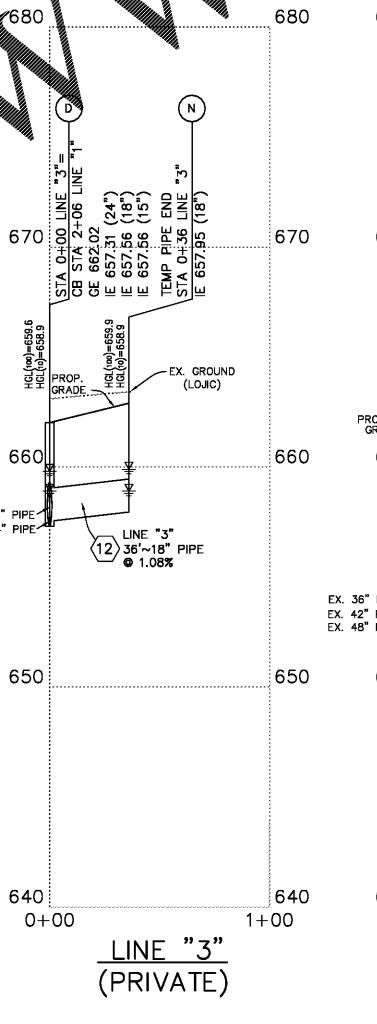
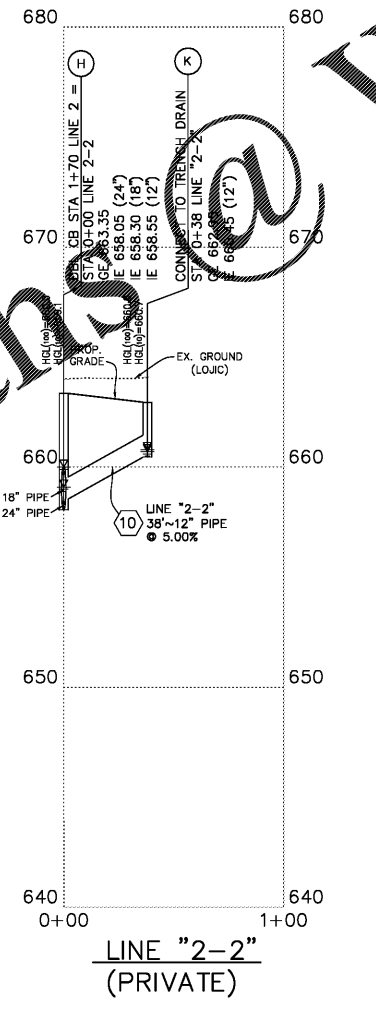
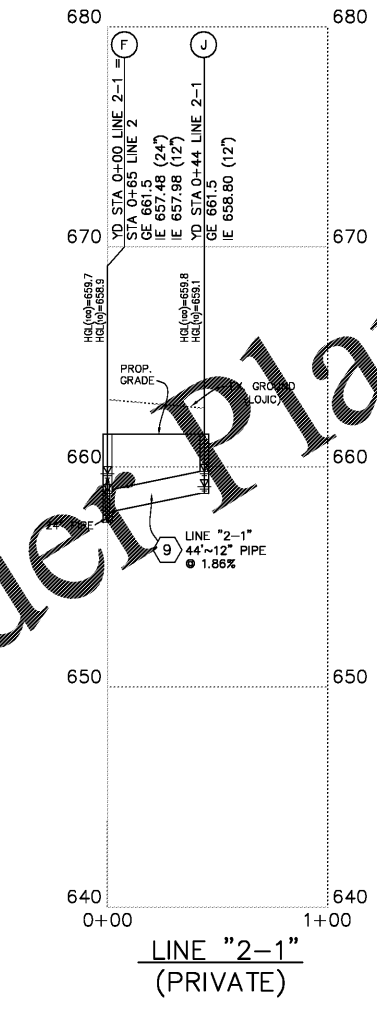
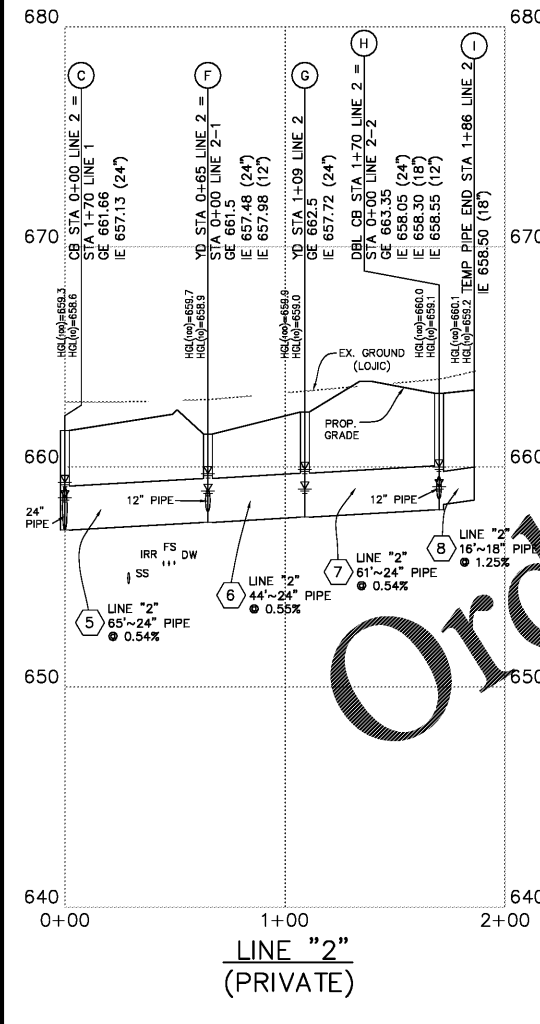
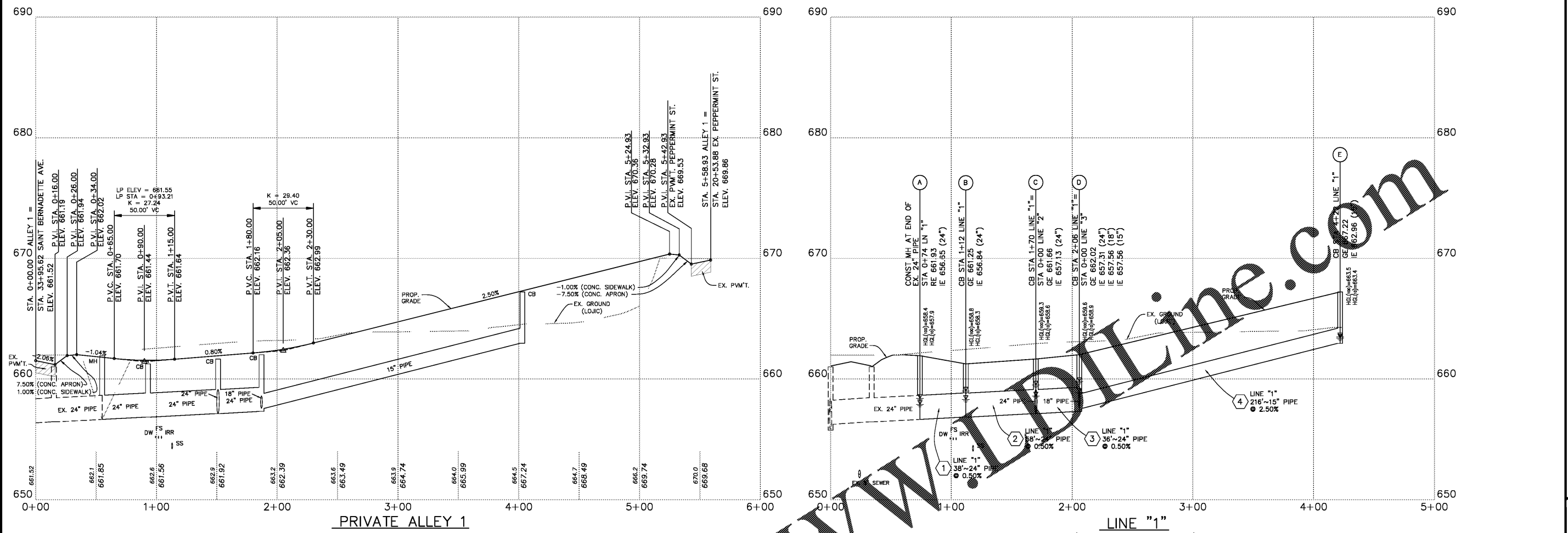
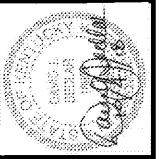

NO.	REVISION	DATE
1.	ADD AND CLIENT COMMENTS	8/27/18

SHEET TITLE: STORM & ALLEY PROFILES
 PROJECT TITLE: LYRIC AT NORTON COMMONS (LOT N701)
 OWNER / DEVELOPER: BRISTOL LYRIC PARTNERS LLC
 381 MALLORY STATION ROAD, STE. 204
 381 MALLORY STATION ROAD, TENNESSEE 37067
 (615) 255-9929

