

**A** MEDICAL TRIAGE 1364  
SCALE: 3/8" = 1'-0"

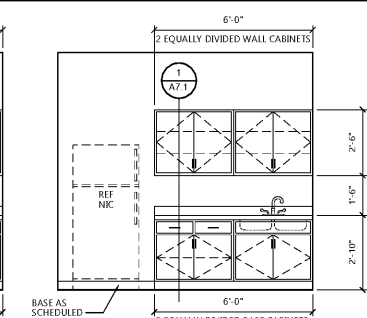

**B** BREAK ROOM AT INFORMATION AREA 1371  
SCALE: 3/8" = 1'-0"

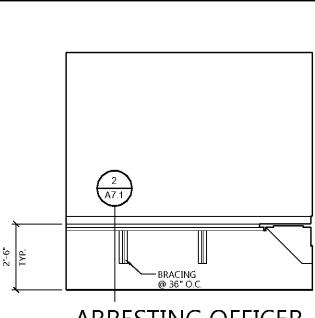

**C** ARRESTING OFFICER WORKROOM 1351  
SCALE: 3/8" = 1'-0"

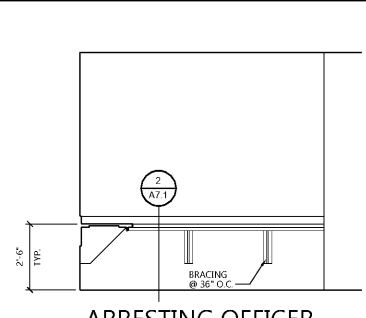

**D** ARRESTING OFFICER WORKROOM 1351  
SCALE: 3/8" = 1'-0"

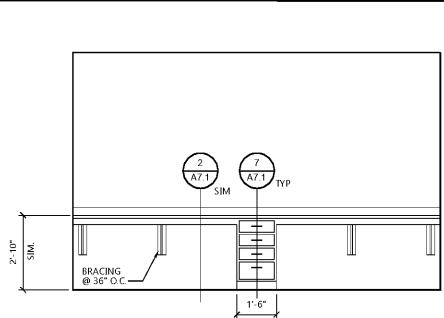

**E** PERSONAL PROPERTY IDENTIFICATION 1360  
SCALE: 3/8" = 1'-0"

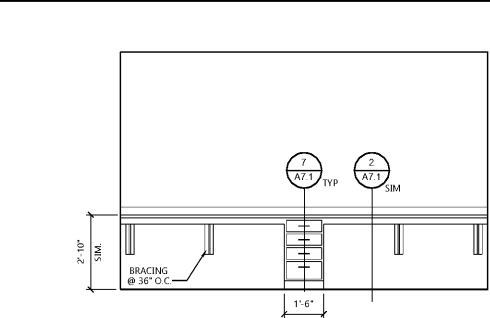

**F** FINGERPRINTING 1362  
SCALE: 3/8" = 1'-0"

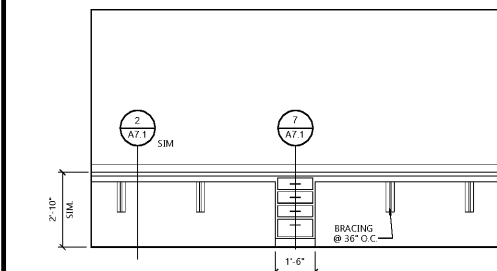

**G** PHOTO IDENTIFICATION 1359  
SCALE: 3/8" = 1'-0"

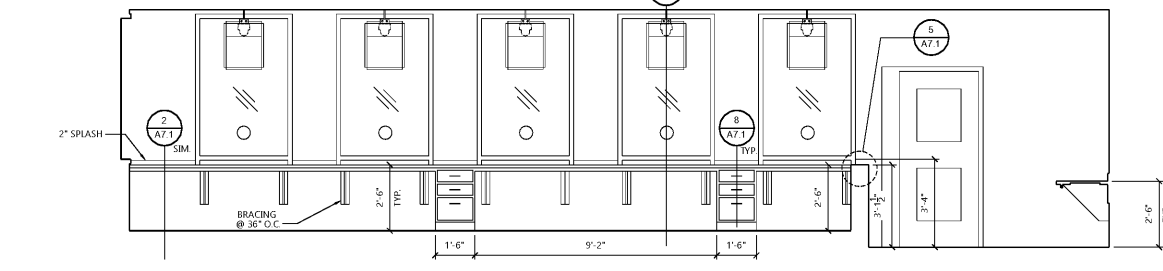

**H** BOOKING DESK AT PROCESSING 1363  
SCALE: 3/8" = 1'-0"

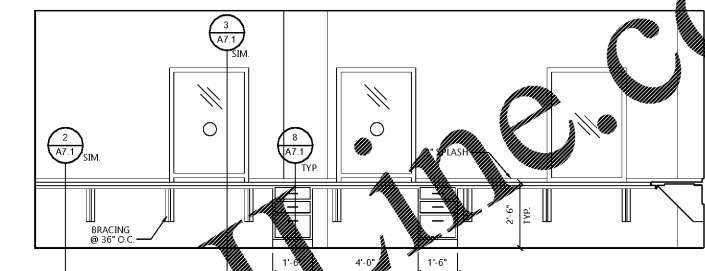

**J** INFORMATION AREA 1371  
SCALE: 3/8" = 1'-0"

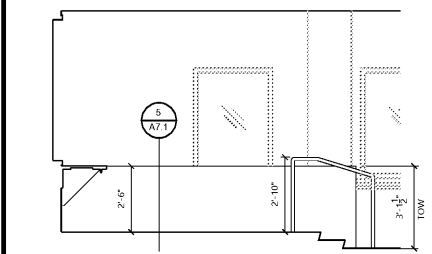

**K** BOOKING DESK AT PROCESSING 1369  
SCALE: 3/8" = 1'-0"

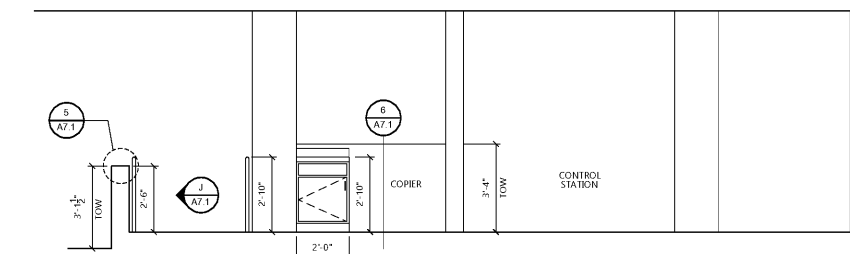

**L** BOOKING DESK AT PROCESSING 1369  
SCALE: 3/8" = 1'-0"

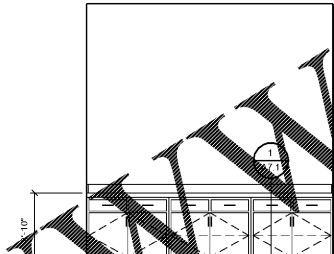

**M** BREATHALYZER ROOM 1361  
SCALE: 3/8" = 1'-0"

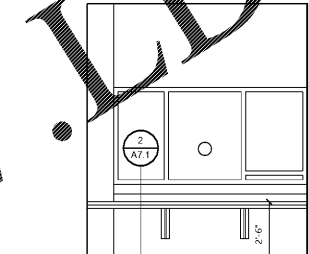

**N** MENTAL HEALTH 1369  
SCALE: 3/8" = 1'-0"

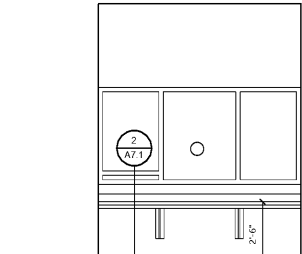

**O** PRE CLASSIFICATION 1349  
SCALE: 3/8" = 1'-0"

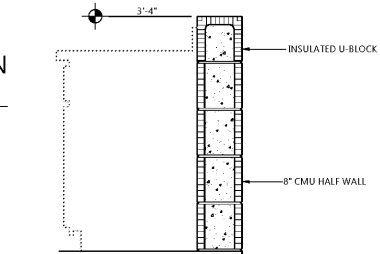

**P** HALF WALL SECTION at COPIER  
SCALE: 1" = 1'-0"

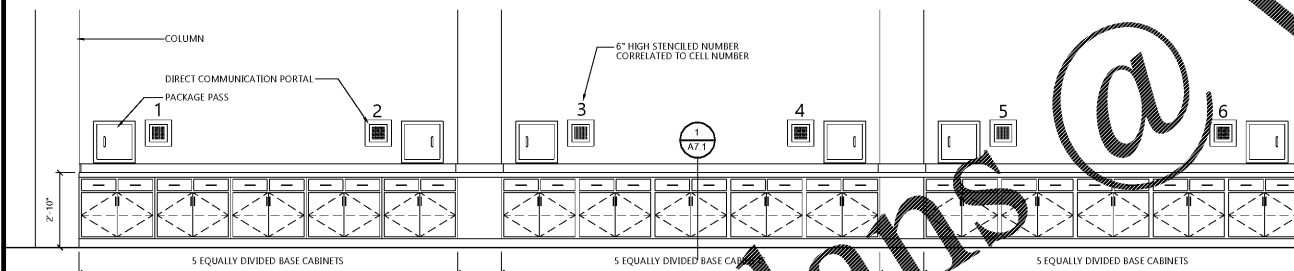

**M** LARGE PROPERTY ROOM 1372  
SCALE: 3/8" = 1'-0"

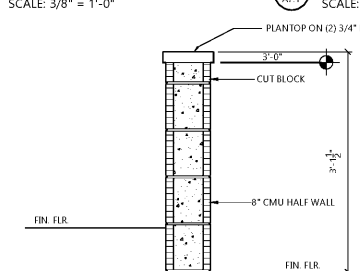

**S** HALF WALL SECTION  
SCALE: 1" = 1'-0"

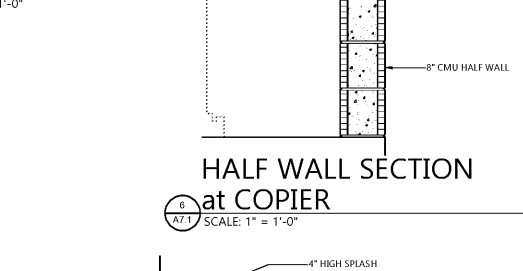

**T** 4 DRAWER BASE SECTION  
SCALE: 3/4" = 1'-0"

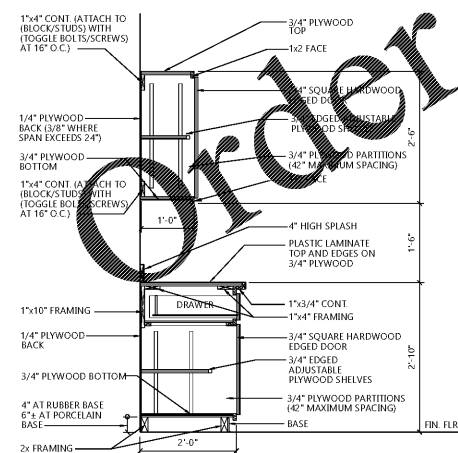

**1** CABINET SECTION  
SCALE: 3/4" = 1'-0"

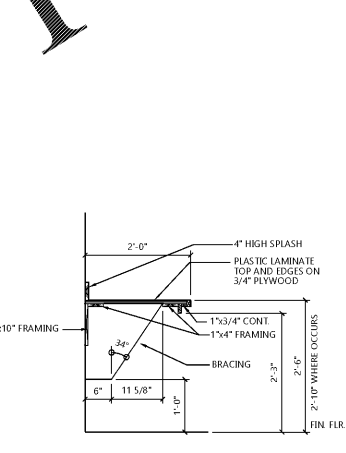

**2** COUNTER TOP SECTION  
SCALE: 3/4" = 1'-0"

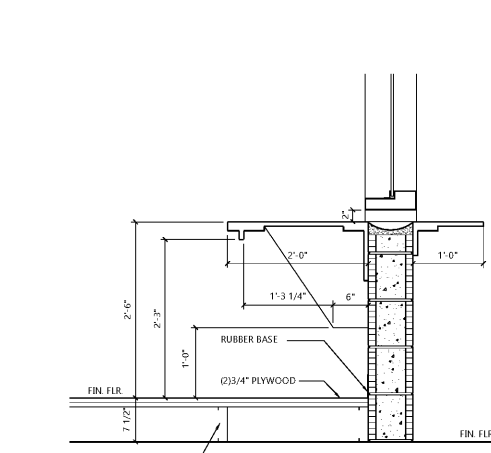

**3** PROCESSING WINDOW SECTION  
SCALE: 1" = 1'-0"

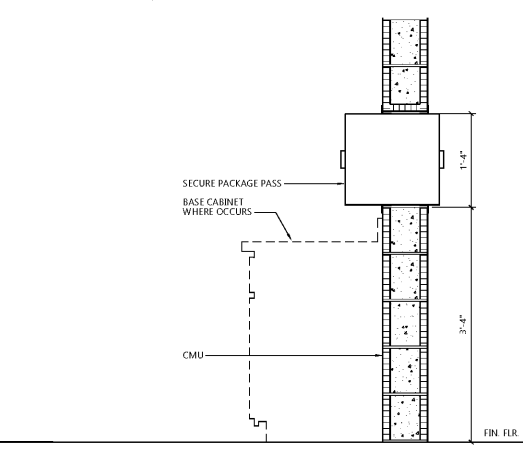

**4** PACKAGE BOX SECTION  
SCALE: 1" = 1'-0"

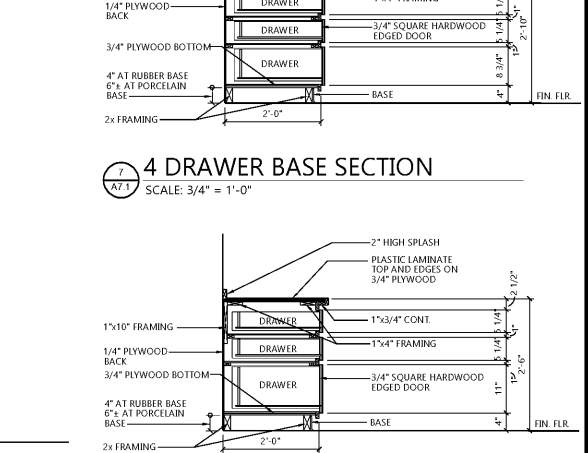

**8** 3 DRAWER BASE SECTION  
SCALE: 3/4" = 1'-0"

Order Plans @ [WWW.LDLINE.COM](mailto:WWW.LDLINE.COM)