

NO.	DATE	DESCRIPTION

DATE: 01/01/2013
 DRAWN BY: ERH
 CHECK BY: RML
 JOB NO: 13-031
 SHEET:

A4.1

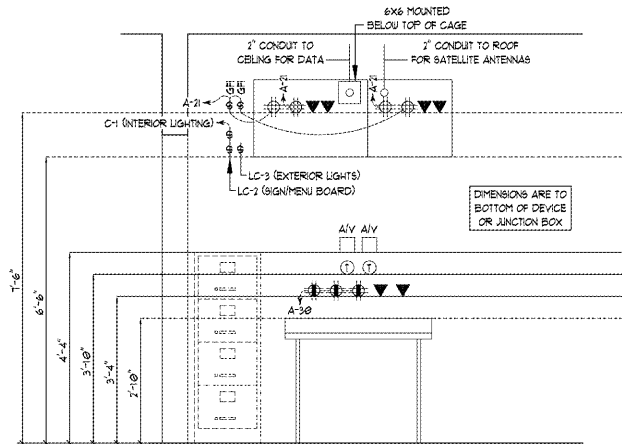

CAGE
 CAGE IS 54" LONG BY 21" HIGH. THE BOTTOM OF THE CAGE IS MOUNTED 6"-6" ABOVE THE FINISHED FLOOR AND CENTERED OVER THE DESK, UNLESS DIRECTED OTHERWISE. RIGHT SIDE OF CAGE NEEDS (1) QUAD DATA WITH TWO 1" CONDUITS. IN ADDITION, NEED (2) QUAD POWER WITH ORANGE RECEPTACLE. ALL RECEPTACLES IN THIS CABINET NEED TO BE ISOLATED GROUND.
 PROVIDE KILL SWITCH FOR POWER ON LEFT AND RIGHT SIDE OF CAGE, TO BE CONTROLLED INDEPENDENTLY. CAN BE MOUNTED TO SIDE OF CAGE BUT NEEDS TO BE HIGH TO PREVENT TURNING OFF CAGE POWER ACCIDENTALLY.
 SEE ELECTRICAL DRAWINGS FOR INFORMATION.

1
 A4.1
OFFICE CAGE ELEVATION
 SCALE: N.T.S.

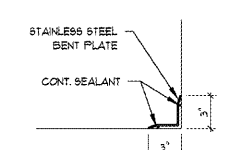

4
 A4.1
TYPICAL OUTSIDE CORNER DETAIL
 SCALE: 1-1/2"=1'-0"

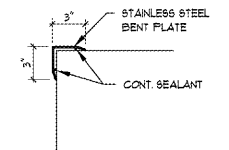

5
 A4.1
TYPICAL INSIDE CORNER DETAIL
 SCALE: 1-1/2"=1'-0"

2
 A4.1
DRIVE THRU LOOP DIAGRAM DETAIL
 SCALE: N.T.S.

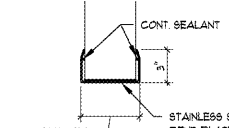
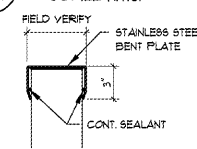

6
 A4.1
TYPICAL WALL END DETAIL
 SCALE: 1-1/2"=1'-0"

7
 A4.1
TYPICAL HEADER DETAIL
 SCALE: 1-1/2"=1'-0"

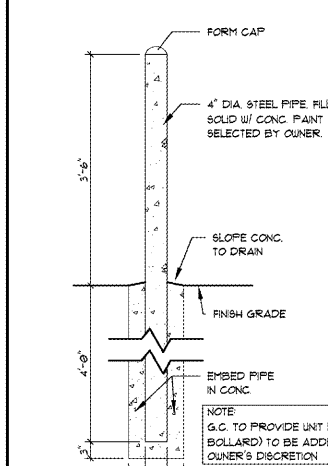

9
 A4.1
BOLLARD SECTION
 SCALE: 3"=1'-0"

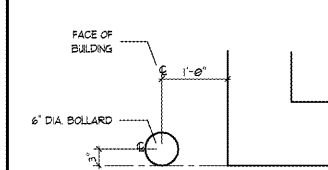

10
 A4.1
BOLLARD DETAIL
 SCALE: 3"=1'-0"

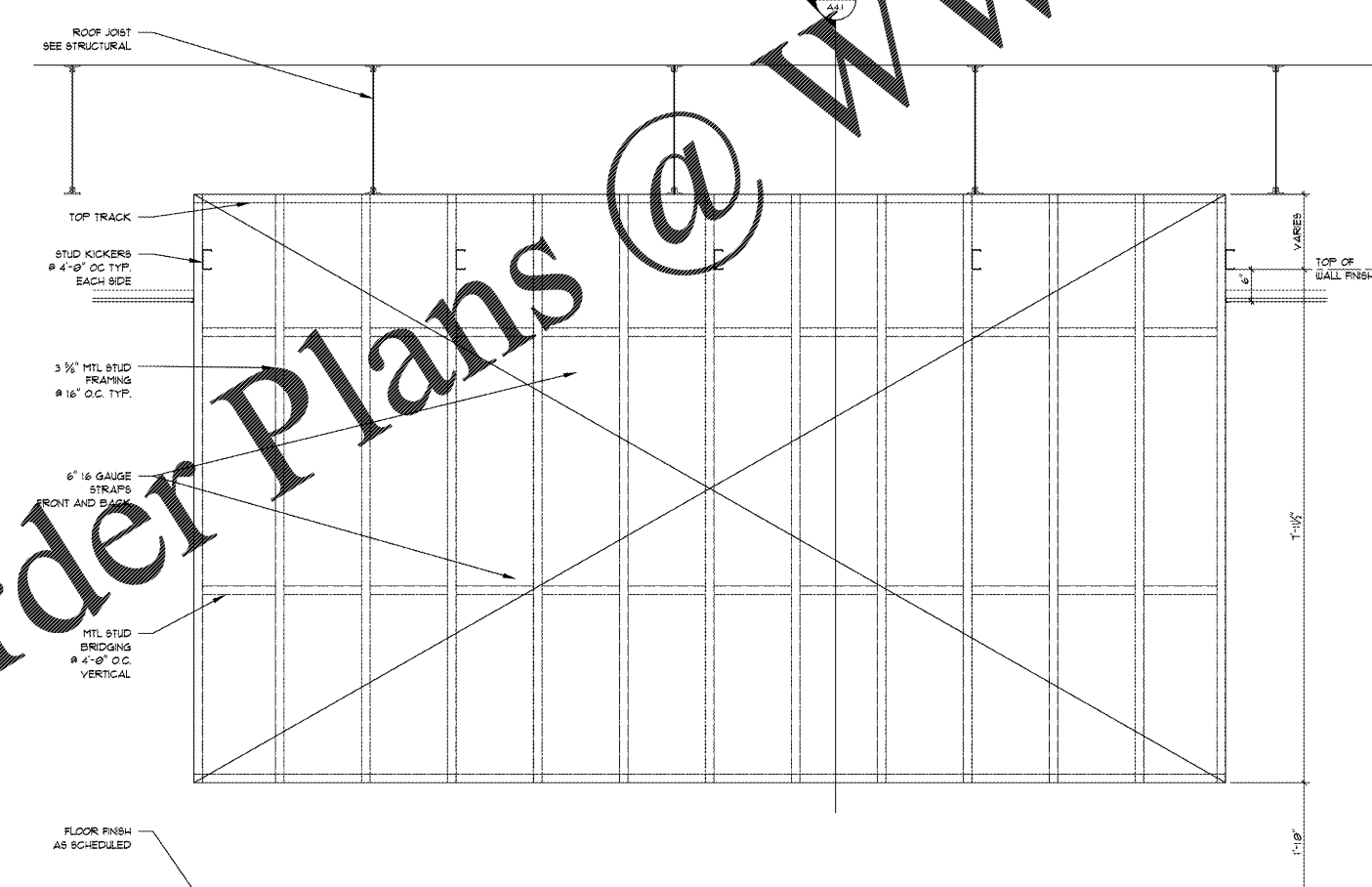

11
 A4.1
SUSPENDED HOOD DETAIL
 SCALE: 3/4"=1'-0"

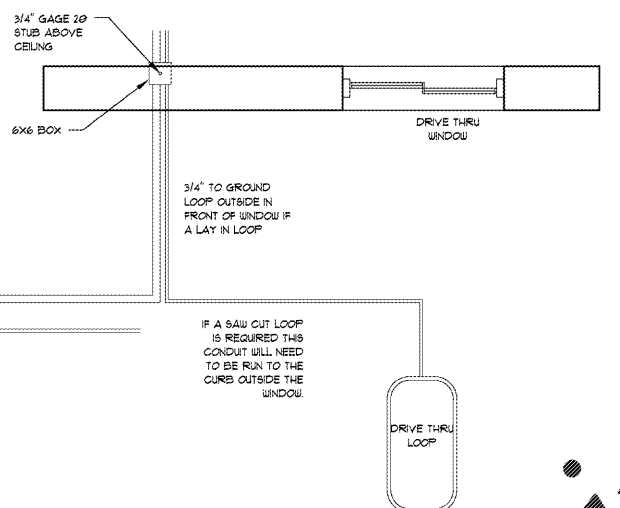

3
 A4.1
SODA LINE WRAP DETAIL
 SCALE: 3"=1'-0"

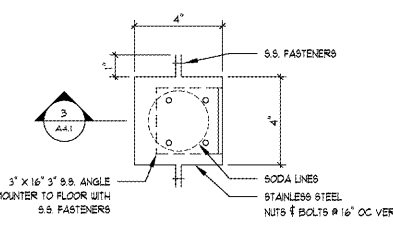

8
 A4.1
SODA LINE WRAP DETAIL
 SCALE: 3"=1'-0"

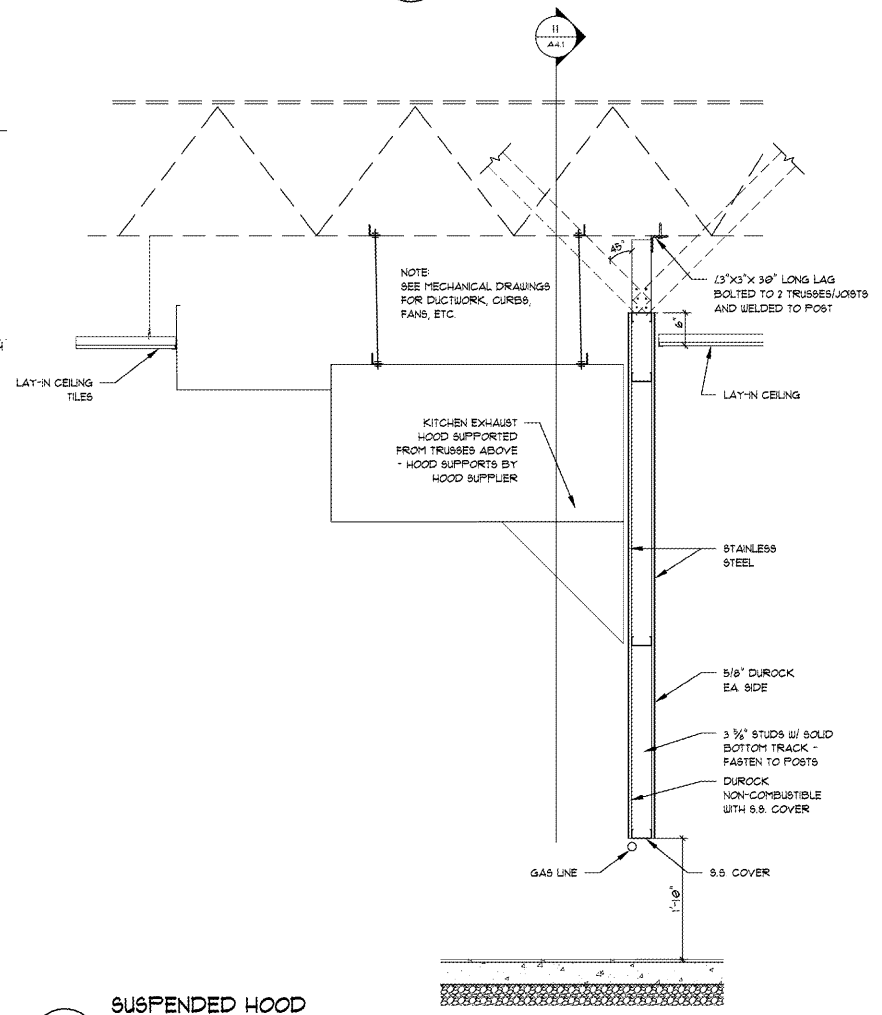

12
 A4.1
SUSPENDED HOOD SECTION
 SCALE: 3/4"=1'-0"

Order Plans @ WWW.LDILine.com