

NETWORK ZONE SYSTEM ENCLOSURE
No Scale

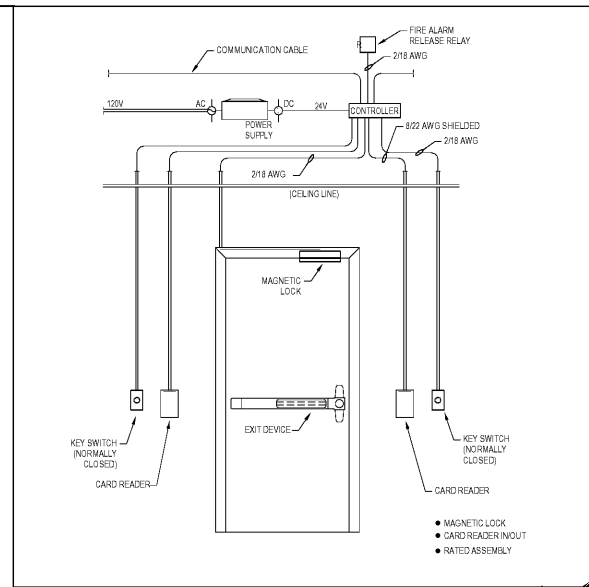

SECURITY DOOR WIRING DETAIL - LAC05
No Scale

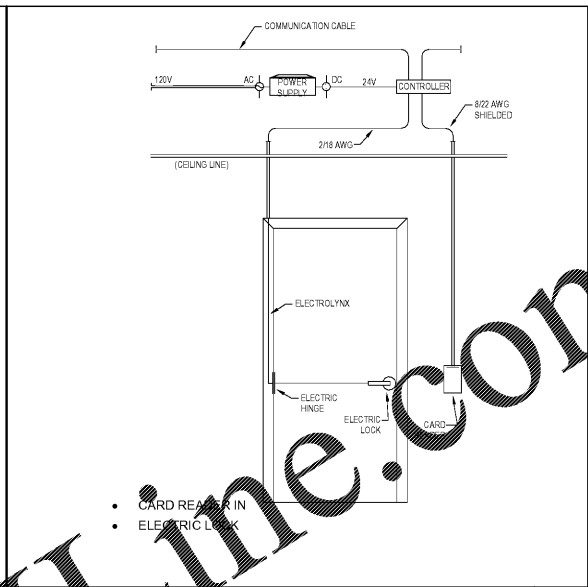

SECURITY DOOR WIRING DETAIL - LAC01
No Scale

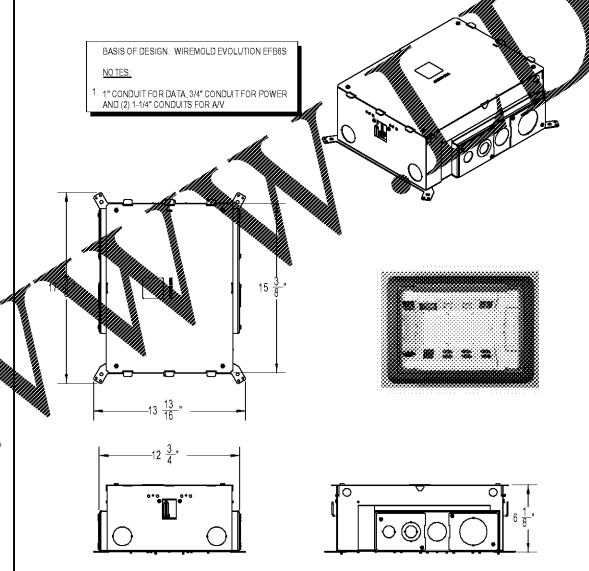

TYPE A FLOORBOX - WIREMOLD EFB6S
No Scale

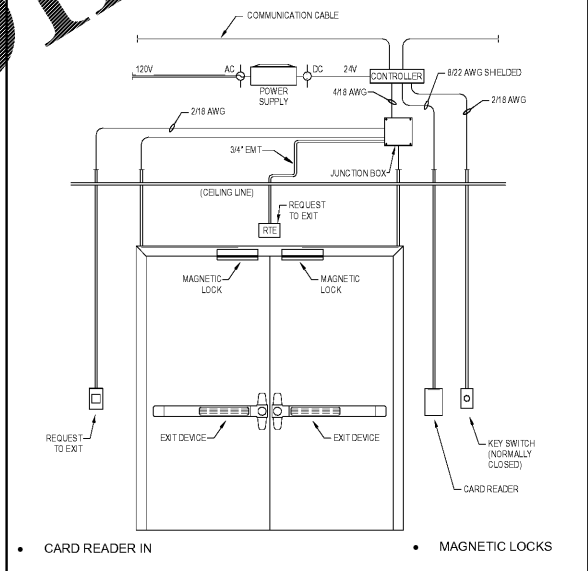

SECURITY DOOR WIRING DETAIL - LAC25
No Scale

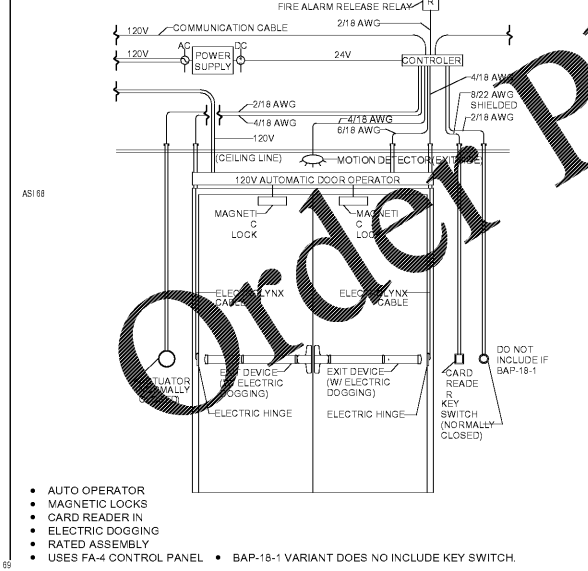

LAC-18 DOOR WIRING DIAGRAM
SCALE N.T.S.

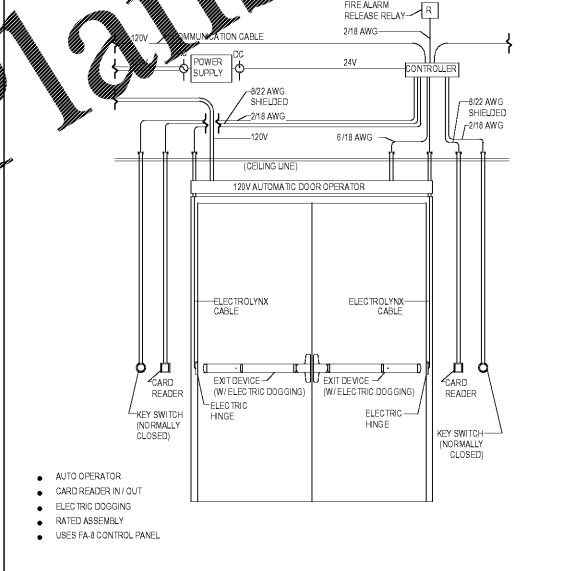

SECURITY DOOR WIRING DETAIL - LAC24
No Scale

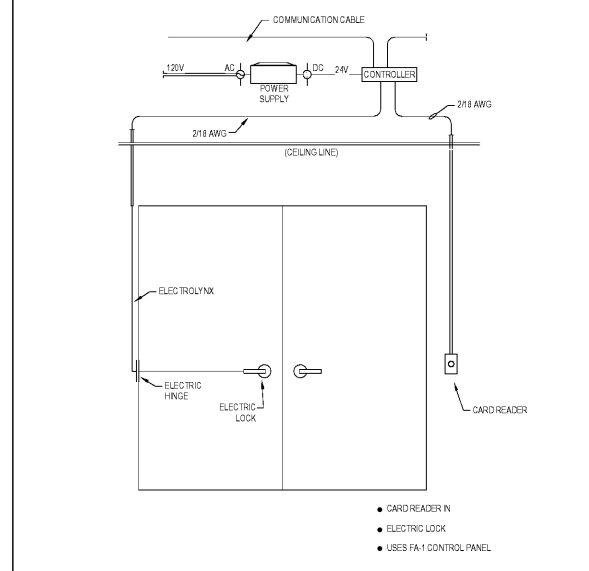

SECURITY DOOR WIRING DETAIL - LAC23
No Scale

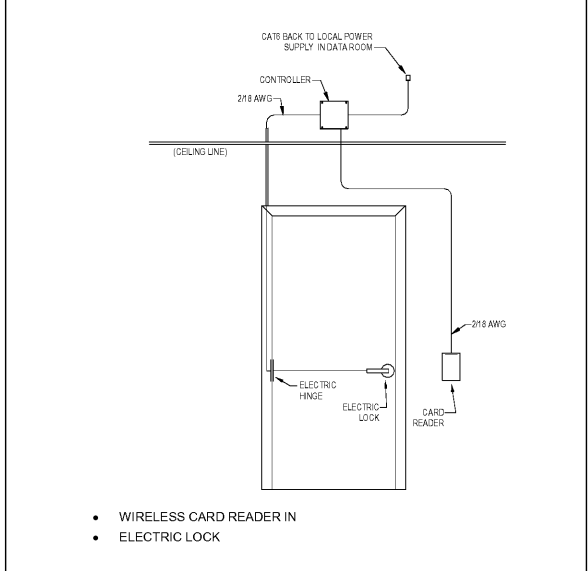

SECURITY DOOR WIRING DETAIL - POE
No Scale



Project
**THE CENTER FOR
ADVANCED SURGICAL
SERVICES (CASS)**
88 JESSE HILL DRIVE
ATLANTA, GA 30303

Prepared For
GRADY HEALTH SYSTEM
80 JESSE HILL DR. SE
ATLANTA, GA 30303



Hellmuth, Obata & Kassabaum, Inc.
191 Peachtree Street, NE, Suite 2250
Atlanta, GA 30303 USA
+1 404 439 9000 +1 404 439 9001

All reproduction & intellectual property rights reserved © 2012
In Association with
TLC ENGINEERING
255 S. Orange Avenue
Suite 1000
Orlando, FL 32801
P 407.841.9800
TLC No. 118648
FAX 407.841.9800

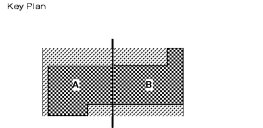

Professional Seal
Emory Neal Boothe, P.E.
Georgia License #PE039005

**NOT FOR
CONSTRUCTION**

No.	Description	Date
3	DO - GMP	2/18/07-03

Project No. 18.16013.00
Sheet Title
TECHNOLOGY DETAILS

Original is 20" x 42". Do not scale outside of this drawing.
Sheet Number

T703