

16 MAMMO STEREO - W  
3/8" = 1'-0"

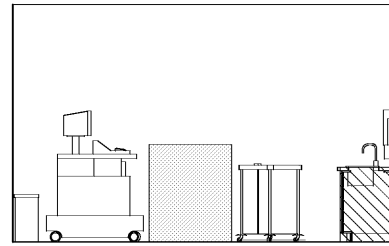

12 BREAST ULTRA - W  
3/8" = 1'-0"

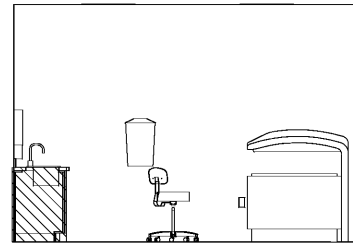

8 BONE DENSITOMETRY - W  
3/8" = 1'-0"

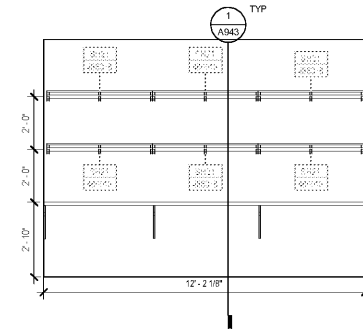

4 ORTHO TYP TOUCHDOWN STATION  
3/8" = 1'-0"

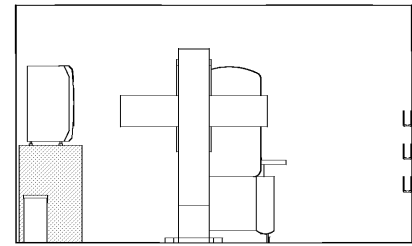

15 MAMMO STEREO - S  
3/8" = 1'-0"

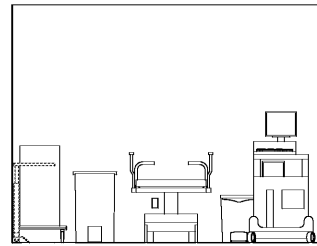

11 BREAST ULTRA - S  
3/8" = 1'-0"

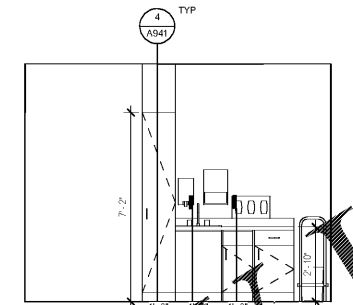

7 BONE DENSITOMETRY - S  
3/8" = 1'-0"

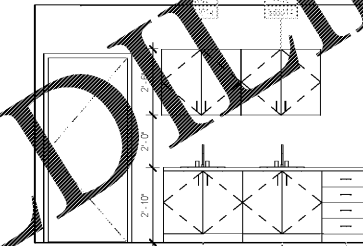

3 INFUSION STAFF LOUNGE  
3/8" = 1'-0"

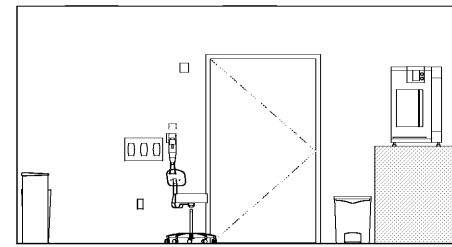

14 MAMMO STEREO - E  
3/8" = 1'-0"

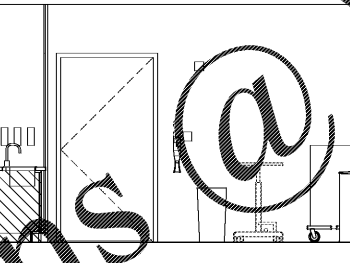

10 BREAST ULTRA - E  
3/8" = 1'-0"

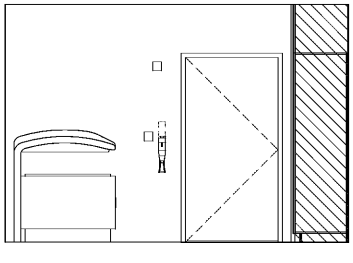

6 BONE DENSITOMETRY - E  
3/8" = 1'-0"

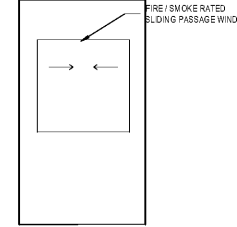

2 TYP RX DISTRIBUTION - E  
3/8" = 1'-0"

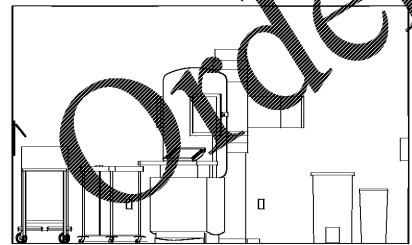

13 MAMMO STEREO - N  
3/8" = 1'-0"

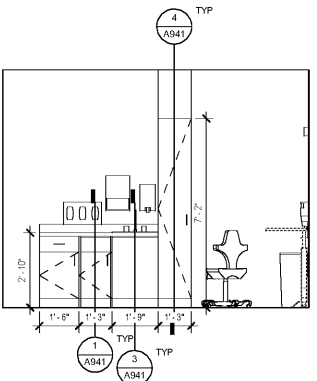

9 BREAST ULTRA - N  
3/8" = 1'-0"

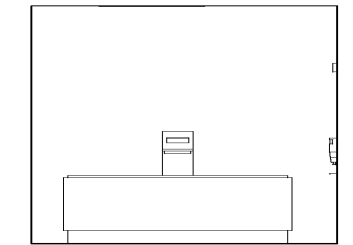

5 BONE DENSITOMETRY - N  
3/8" = 1'-0"

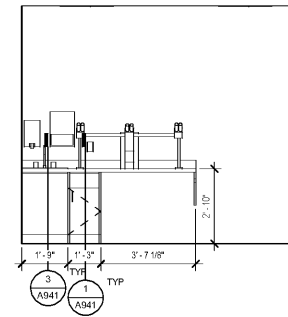

1 FNA ROOM - E  
3/8" = 1'-0"

SHEET SPECIFIC NOTES

- A. GENERAL NOTES:**
1. TRUE NORTH USED FOR NORTH, EAST, SOUTH, AND WEST DESIGNATIONS. REFER TO NORTH ARROW ON FLOOR PLANS.
  2. EQUIPMENT IS SHOWN FOR SPACE PLANNING AND MOUNTING-HEIGHT PURPOSES ONLY. REFER TO MEDICAL EQUIPMENT DRAWINGS FOR QUANTITIES, DIMENSIONS, POWER REQUIREMENTS AND ADDITIONAL INFORMATION.
  3. ALL CASEWORK TO BE LOCKABLE, U.N.O.
  4. REFER TO ENLARGED PLANS, ELEVATIONS AND DETAILS FOR CLARIFICATION OF EXTENT OF FINISH MATERIALS AND ADDITIONAL INFORMATION.
  5. REFER TO A940 SERIES SHEETS FOR TYPICAL CASEWORK SECTIONS AND GENERAL NOTES.
  6. REFER TO A220 SERIES FINISH PLANS FOR FINISH & WALL PROTECTION SYSTEM EXTENTS AND INFORMATION.
  7. REFER TO A220.1, A220.2 FOR WALL PROTECTION SYSTEM LEGEND AND FINISH SCHEDULE.
  8. WHERE TRANSITIONS OF WALL PROTECTION SYSTEM OCCUR, USE REGLET TRANSITION PIECES AS FOLLOWS:
    - A. AT CORNER TRANSITIONS, USE REGLET TYP 125-21 ANODIZED.
    - B. AT TRANSITION FROM WALL PROTECTION TO GLASS, USE FRY REGLET WC15-217 CLEAR ANODIZED.
    - C. AT TRANSITION FROM WALL PROTECTION TO WALL PROTECTION USE WC15-217 CLEAR ANODIZED.
- B. DEFINITIONS:**
1. GWS - GYPSUM WALL BOARD
  2. W - WALL PROTECTION SYSTEM.



Project  
**THE CENTER FOR  
ADVANCED SURGICAL  
SERVICES (CASS)**  
80 GILMER STREET SE  
ATLANTA, GA 30303

Prepared For  
**GRADY HEALTH SYSTEM**  
80 JESSE HILL DR. SE  
ATLANTA, GA 30303



Hok  
Hok, Inc. (Hok & Kastbaum, Inc.)  
133 Peachtree Street, NE, Suite 4800  
Atlanta, GA 30303 USA  
+1 404 439 9000 +1 404 439 9001

All reproduction & intellectual property rights reserved ©  
2019  
in Association with

Key Plan

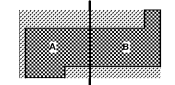

Professional Seal

**NOT FOR  
CONSTRUCTION**

No.	Description	Date
1	ED - GMP	2019.07.03

Project No: 18.16013.00  
Sheet Title

**CLINICAL ELEVATIONS  
- LEVEL 08**

Original is 20 x 43. Do not scale contents of this drawing.  
Sheet Number

**A648.2**