

16 TYP ORTHO PROCEDURE - W
3/8" = 1'-0"

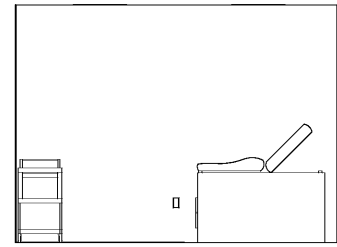

12 CASTING - W
3/8" = 1'-0"

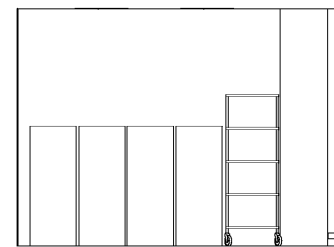

8 ORTHO PROCEDURE - W
3/8" = 1'-0"

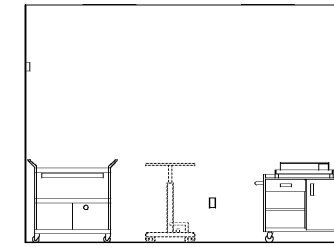

4 SPLINT CASTING - W
3/8" = 1'-0"

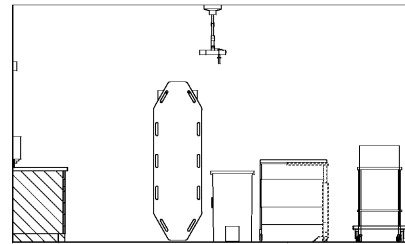

15 TYP ORTHO PROCEDURE - S
3/8" = 1'-0"

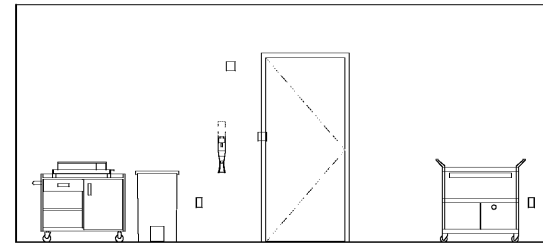

11 CASTING - S
3/8" = 1'-0"

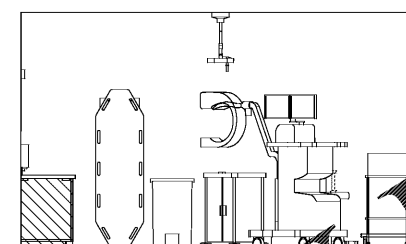

7 ORTHO PROCEDURE - S
3/8" = 1'-0"

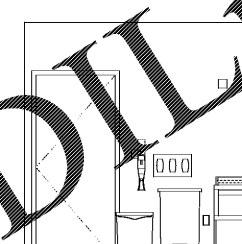

3 SPLINT CASTING - S
3/8" = 1'-0"

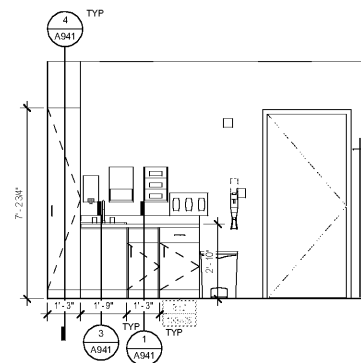

14 TYP ORTHO PROCEDURE - E
3/8" = 1'-0"

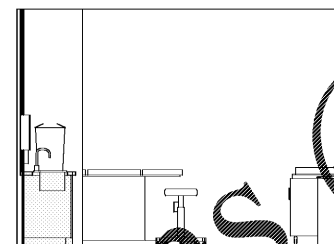

10 CASTING - E
3/8" = 1'-0"

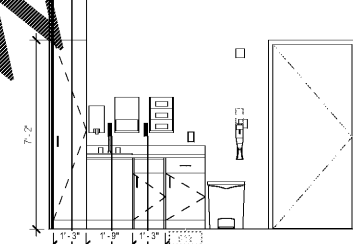

6 ORTHO PROCEDURE - E
3/8" = 1'-0"

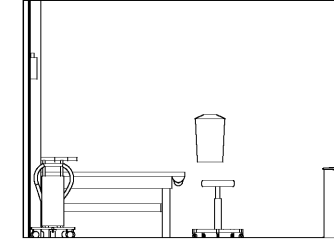

2 SPLINT CASTING - E
3/8" = 1'-0"

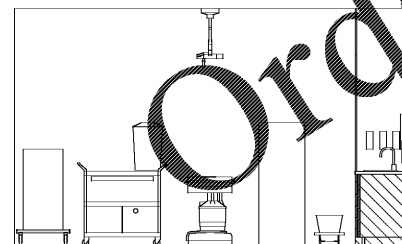

13 TYP ORTHO PROCEDURE - N
3/8" = 1'-0"

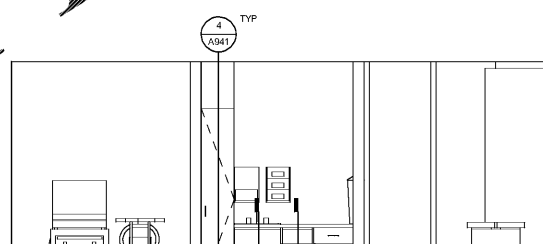

9 CASTING - N
3/8" = 1'-0"

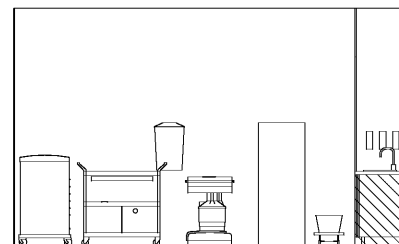

5 ORTHO PROCEDURE - N
3/8" = 1'-0"

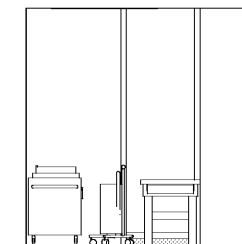

1 SPLINT CASTING - N
3/8" = 1'-0"

SHEET SPECIFIC NOTES

- A. GENERAL NOTES:**
1. TRUE NORTH USED FOR NORTH, EAST, SOUTH, AND WEST DESIGNATIONS. REFER TO NORTH ARROW ON FLOOR PLANS.
 2. EQUIPMENT IS SHOWN FOR SPACE PLANNING AND MOUNTING-HEIGHT PURPOSES ONLY. REFER TO MEDICAL EQUIPMENT DRAWINGS FOR QUANTITIES, DIMENSIONS, POWER REQUIREMENTS AND ADDITIONAL INFORMATION.
 3. ALL CASEWORK TO BE LOOKABLE, U.N.O.
 4. REFER TO ENLARGED PLANS, ELEVATIONS AND DETAILS FOR CLARIFICATION OF EXTENT OF FINISH MATERIALS AND ADDITIONAL INFORMATION.
 5. REFER TO AIAQ SERIES SHEETS FOR TYPICAL CASEWORK SECTIONS AND GENERAL NOTES.
 6. REFER TO A220 SERIES FINISH PLANS FOR FINISH & WALL PROTECTION SYSTEM EXTENTS AND INFORMATION.
 7. REFER TO A220.1, A220.2 FOR WALL PROTECTION SYSTEMS. REFER TO FINISH SCHEDULE.
 8. WHERE TRANSITIONS OF WALL PROTECTION SYSTEM USE REGLET TRANSITIONS PIECES AS FOLLOWS:
 - A. AT CORNER TRANSITION USE REGLET 125-217 CLEAR ANODIZED
 - B. AT TRANSITION FROM WALL PROTECTION TO GYP USE FRY REGLET WCTBT 125-217 CLEAR ANODIZED
 - C. AT TRANSITION FROM WALL PROTECTION TO WALL PROTECTION USE WCTBT 125-217 CLEAR ANODIZED
- B. DEFINITIONS:**
1. GWB - GYPSUM WALL BOARD
 2. WPS - WALL PROTECTION SYSTEM



Project
**THE CENTER FOR
ADVANCED SURGICAL
SERVICES (CASS)**
80 GILMER STREET SE
ATLANTA, GA 30303

Prepared For
GRADY HEALTH SYSTEM
80 JESSE HILL DR. SE
ATLANTA, GA 30303



Hok, Inc. - Oates & Kastbaum, Inc.
133 Peachtree Street, NE, Suite 4800
Atlanta, GA 30303 USA
1+1 404 439 9000 1+1 404 439 9001

All reproduction & intellectual property rights reserved ©
2019
In Association with

Key Plan

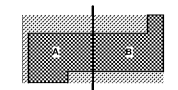

Professional Seal

**NOT FOR
CONSTRUCTION**

No.	Description	Date
1	ED - GMP	2019-07-03

Project No: 18.16013.00
Sheet Title
**CLINICAL ELEVATIONS
- LEVEL 07**

Original is 20 x 43. Do not scale contents of this drawing
Sheet Number

A647.2