

14 MEZZANINE TO EXIST. STOREFRONT, TYP.
1 1/2" = 1'-0"

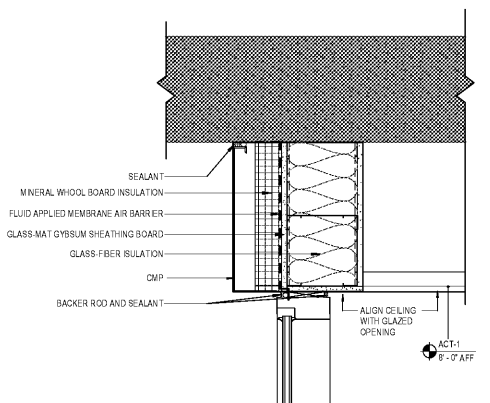

13 SF HEAD AT GYM ENTRY
1 1/2" = 1'-0"

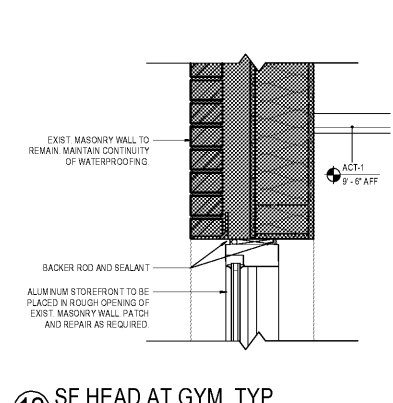

12 SF HEAD AT GYM, TYP.
1 1/2" = 1'-0"

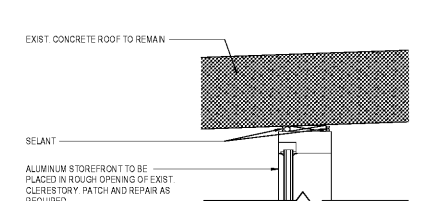

11 GYM CLERESTORY SF - HEAD, TYP.
1 1/2" = 1'-0"

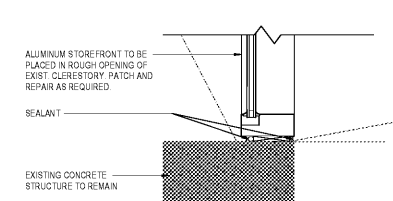

10 GYM CLERESTORY SF - SILL, TYP.
1 1/2" = 1'-0"

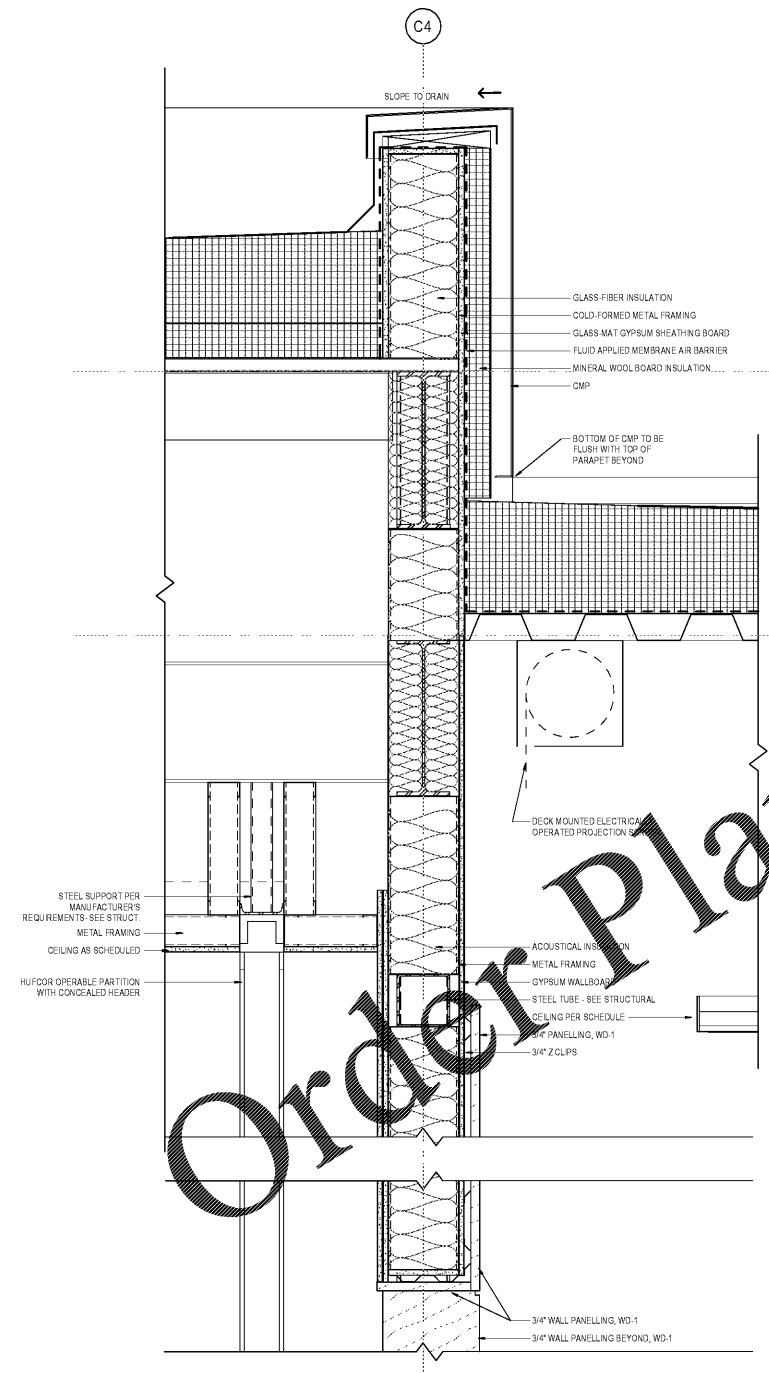

4 SECTION DETAIL
1 1/2" = 1'-0"

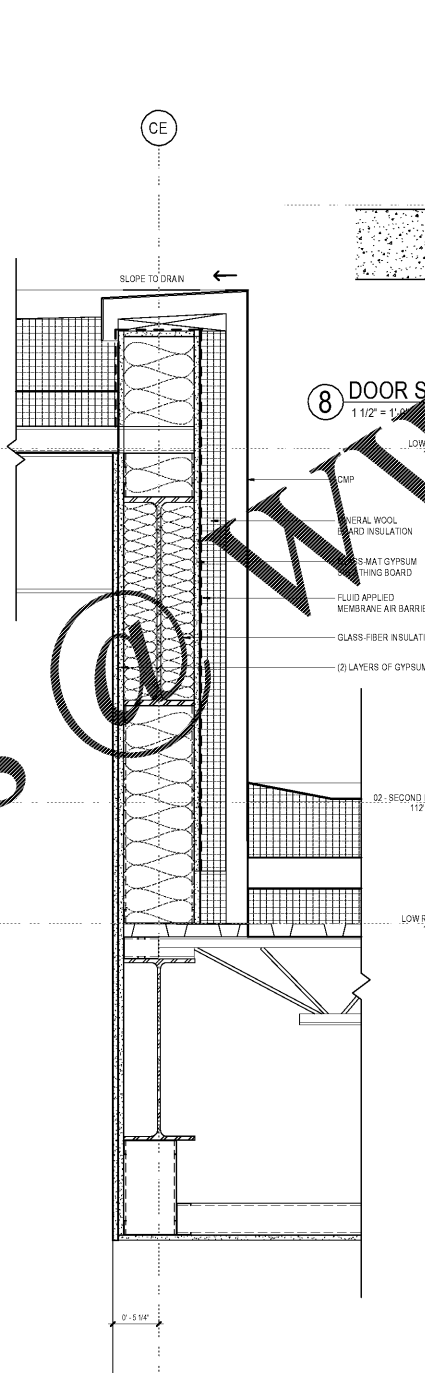

3 HIGH ROOF TO LOW ROOF TRANSITION
1 1/2" = 1'-0"

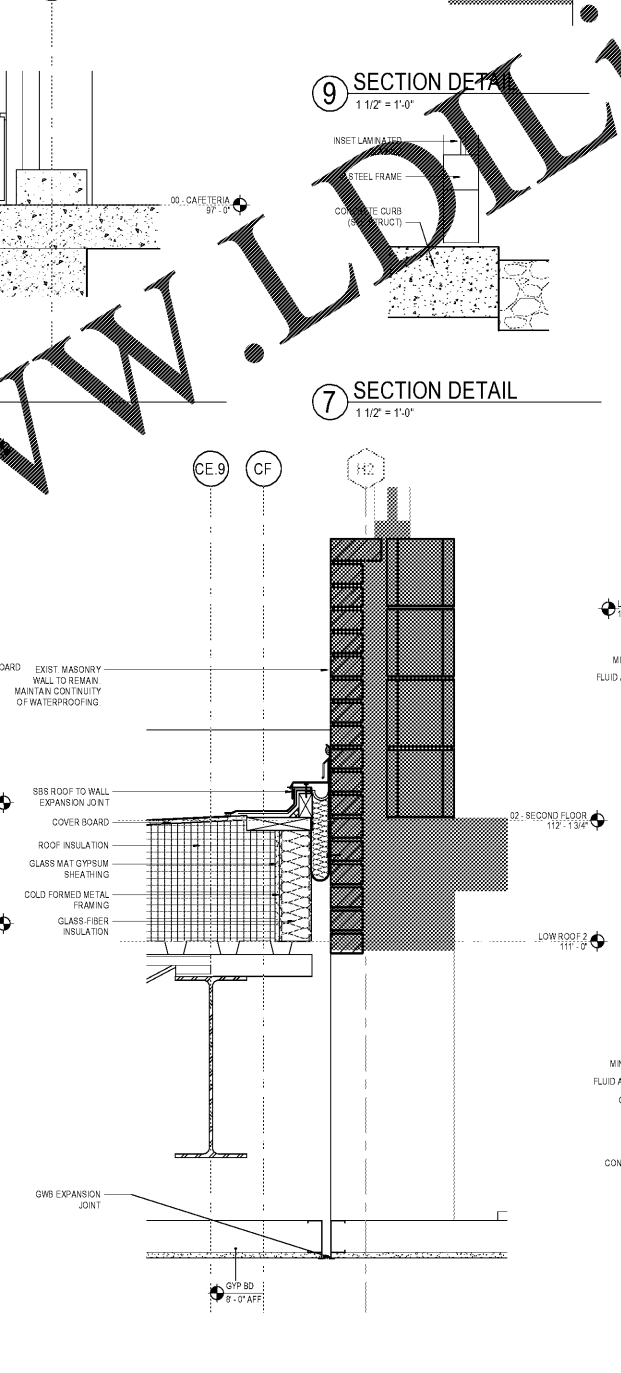

2 EXPANSION JOINT AT LOW ROOF
1 1/2" = 1'-0"

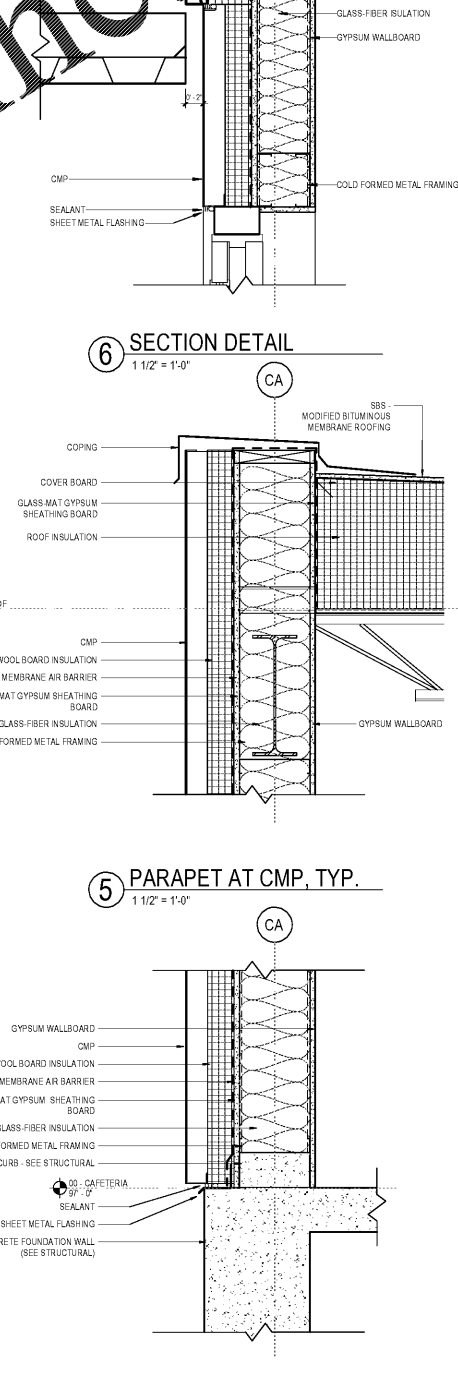

1 SILL W/ CURB AT CMP
1 1/2" = 1'-0"

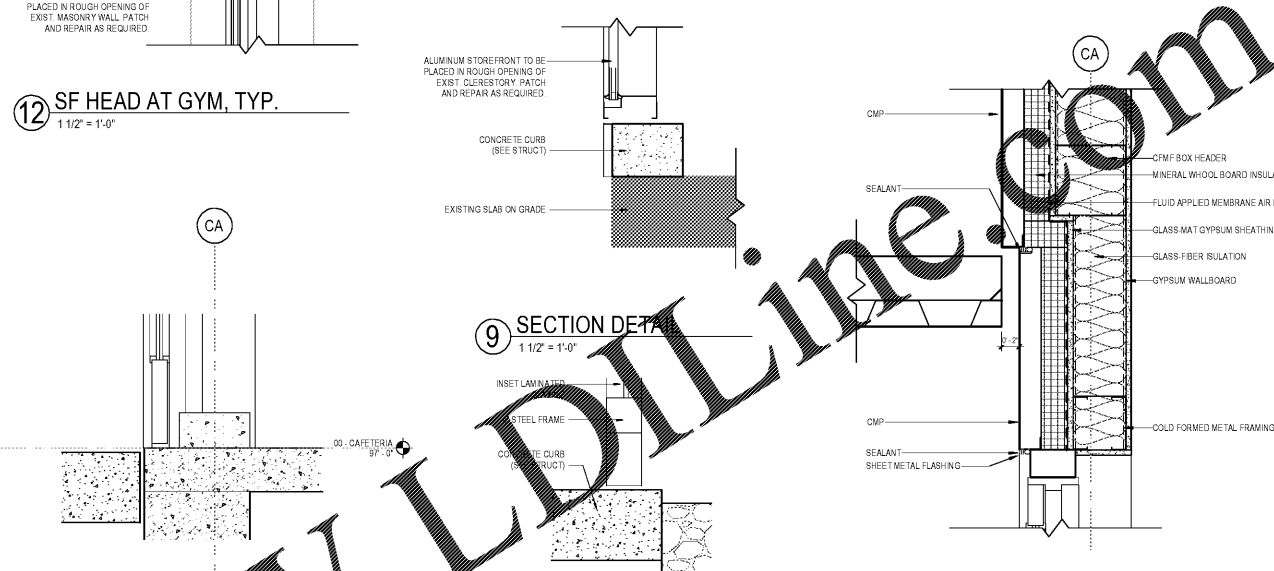

9 SECTION DETAIL
1 1/2" = 1'-0"

7 SECTION DETAIL
1 1/2" = 1'-0"

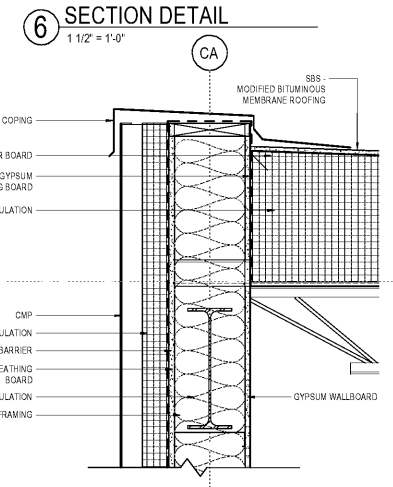

6 SECTION DETAIL
1 1/2" = 1'-0"

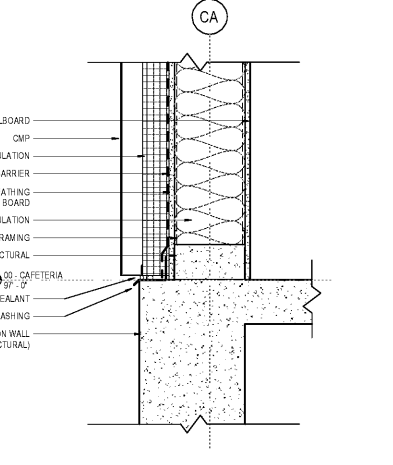

5 PARAPET AT CMP, TYP.
1 1/2" = 1'-0"

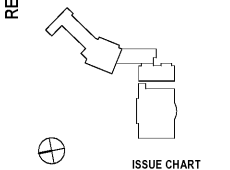

DATE	BY	DATE
Job Number	801660.000	
Drawn	Author	
Checked	Checker	
Approved	Approver	

Order Plans

WWW.LDILINE.COM