

1217 JORDAN LANE  
HUNTSVILLE, AL. 35816  
OFFICE: 256-799-7023  
FAX: 256-837-3443

THIS SET OF DOCUMENTS AND THE DESIGN SHOWN HEREIN ARE THE PROPERTY OF DYKES FOODSERVICE SOLUTIONS, INC. REPRODUCTION VIOLATION OR ANY OTHER UNAUTHORIZED USE OF THESE DOCUMENTS WITHOUT THE WRITTEN CONSENT OF DYKES FOODSERVICE SOLUTIONS WILL BE SUBJECT TO LEGAL ACTION.

PROJECT NAME:  
**Captain D's**  
**GAFFNEY, S.C.**

DRAWN BY: CHAD C.

CHECKED BY: ERIC W.

REVISION NO. DATE:

AS BUILT DRAWING DATE: \*

DRAWING APPROVAL

- DRAWING APPROVED
- APPROVED AS NOTED
- RESUBMIT DRAWING

SIGNATURE

PROJECT NO.:  
CDPL-44E-18  
FD-MODIFIED

DRAWING DATE:

1-19-18

TITLE:

ELEVATIONS

SHEET NO.:

K-ELEV-1

SCALE:

1/4" = 1'-0"

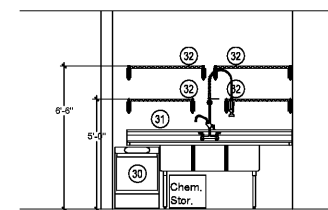

1 POT WASH / PREP AREA

SCALE 1/4" = 1'-0"

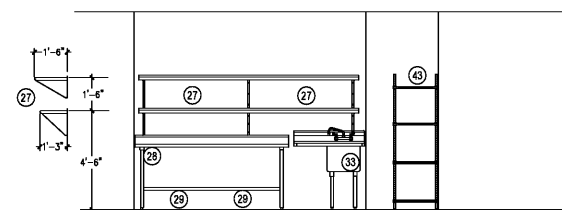

2 PREP AREA

SCALE 1/4" = 1'-0"

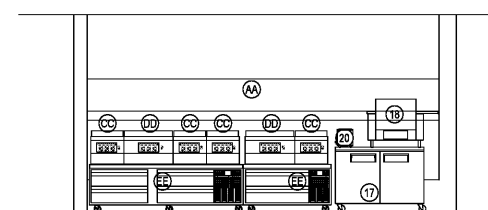

5 COOK LINE AREA

SCALE 1/4" = 1'-0"

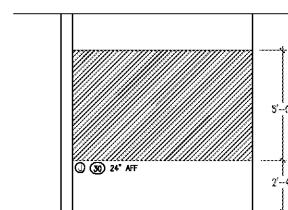

1 POT WASH / PREP AREA WALL BACKING

SCALE 1/4" = 1'-0"

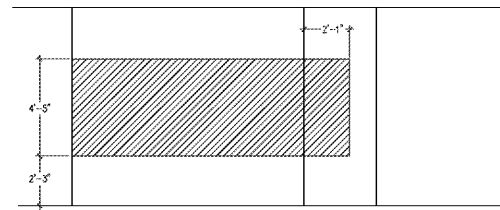

2 PREP AREA WALL BACKING

SCALE 1/4" = 1'-0"

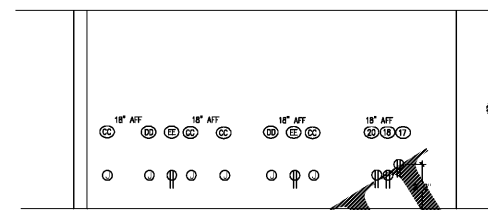

5 COOK LINE AREA ELECTRICAL

SCALE 1/4" = 1'-0"

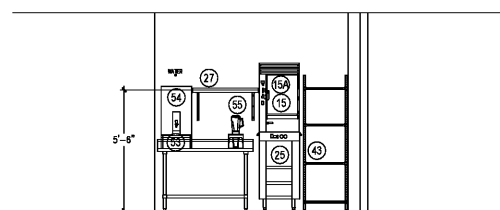

3 PREP AREA

SCALE 1/4" = 1'-0"

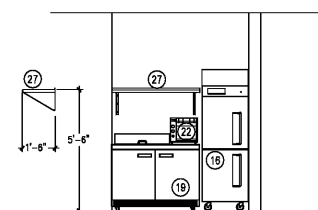

4 SIDE PREP AREA

SCALE 1/4" = 1'-0"

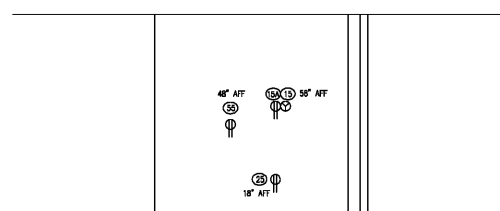

3 PREP AREA ELECTRICAL

SCALE 1/4" = 1'-0"

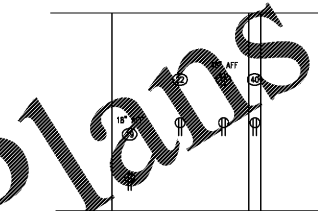

4 SIDE PREP AREA ELECTRICAL

SCALE 1/4" = 1'-0"

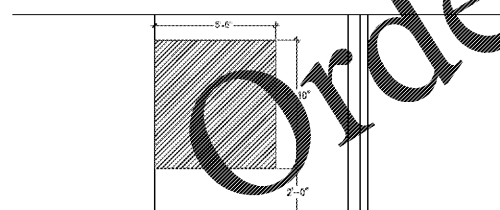

3 PREP AREA WALL BACKING

SCALE 1/4" = 1'-0"

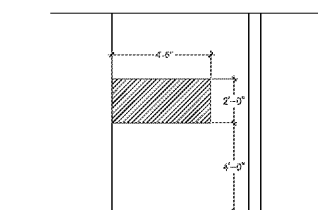

4 SIDE PREP AREA WALL BACKING

SCALE 1/4" = 1'-0"

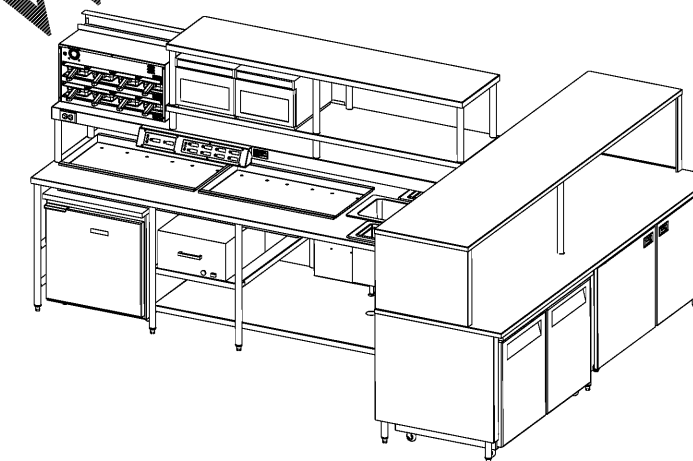

EQUIPMENT				ELECTRICAL							
ITEM	QTY	DESCRIPTION	REMARKS	VOLT	PHASE	LOAD			CONN	LOC. A.F.F.	REMARKS
						AMP	KW	HP			
3	1	U.C. REFRIGERATOR	TURBO AIR # MUR-28	115	1	3.3			P&C	-	NEMA 5-15R
14A	1	HOLDING BIN, HEATED	MARSHALL AIR DH5E-33	120	1	12.9			-	-	20 AMP BREAKER
14a	1	CAPT. TABLE	THERMOGLO WARMER	208	1	13.5			-	-	20 AMP BREAKER
14b	2	CAPT. TABLE	DROP-IN # CZ3K-3	120	1	5.1			-	-	15 AMP BREAKER
14c	1	CAPT. TABLE	WELLS MOD-127TD	208	1	13.8			-	-	20 AMP BREAKER
14d	2	CAPT. TABLE	ROUND UP WARMER # WD-20	120	1	4.2			-	-	15 AMP BREAKER
17	1	DBL. DR. U/C REFG	TURBO AIR # MUR-48	115	1	6.5			P&C	-	NEMA 5-15R CAPTAINS TABLE
23	2	MICROWAVE	AMANA # MDC182	208	1	14.4			P&C	72"	NEMA 6-20R BACK WALL

GENERAL NOTES  
THIS DRAWING IS FOR REFERENCE USE ONLY. NOT FOR CONSTRUCTION.

