

**GENERAL ACCESSIBILITY NOTES**

**THRESHOLDS**

- FLOOR(S) OR LANDING(S) ARE NOT MORE THAN 1/2" LOWER THAN THE TOP OF THE THRESHOLD OF THE DOORWAY.
- PER 303.3 CHANGE IN LEVEL BETWEEN 1/4" AND 1/2" IS BEVELED AT A GRADIENT NOT TO EXCEED 1:2.
- DOORMATS ARE SECURELY ATTACHED (ANCHORED OR RECESSED) AND HAVE A LEVEL LOOP. LEVEL CUT/JUNCT PILE WITH PILE NOT EXCEEDING 1/2" IN HEIGHT.
- EXPOSED EDGES OF DOORMATS ARE FASTENED TO FLOOR SURFACES AND HAVE TRIM ALONG THE ENTIRE LENGTH OF THE EXPOSED EDGE.

**DOORS**

- MINIMUM OF 3'-0" IN WIDTH, 6'-8" IN HEIGHT.
- OPENS A MINIMUM OF 90 DEGREES.
- CLEAR WIDTH OF THE DOORWAY IS 32" MINIMUM.
- DOUBLE DOORS / AUTOMATIC DOORS AT LEAST ONE DOOR MUST COMPLY WITH 1, 2 AND 3 ABOVE.
- BOTTOM 10" OF DOOR HAS A SMOOTH, UNINTERRUPTED SURFACE THAT ALLOWS DOOR TO BE OPENED BY A WHEELCHAIR FOOTREST WITHOUT CREATING A TRAP OR HAZARDOUS CONDITION.

NOTE: WHERE NARROW FRAME DOORS ARE USED A 10" HIGH SMOOTH PANEL MUST BE INSTALLED ON THE PUSH SIDE BOTTOM OF THE DOOR WHICH WILL ALLOW THE DOOR TO BE OPENED BY A WHEELCHAIR FOOTREST WITHOUT CREATING A TRAP OR HAZARDOUS CONDITION.

- EFFORT TO OPERATE DOORS IS WITHIN PRESSURES ALLOWED. INTERIOR DOORS 5 POUNDS MAXIMUM PRESSURE TO OPERATE. FIRE DOORS SEE APPROPRIATE ADMINISTRATIVE AUTHORITY.
- TWO DOORS IN A SERIES PROVIDE A MINIMUM OF 48" CLEAR SPACE FROM ANY DOOR, IN ANY POSITION.

**DOOR HARDWARE**

- EXIT DOORS ARE OPERABLE FROM THE INTERIOR WITHOUT THE USE OF A KEY OR ANY SPECIAL KNOWLEDGE OR EFFORT.
- LATCHING AND LOCKING DOORS THAT ARE USED OPERABLE ARE OPERABLE WITH A SINGLE EFFORT. LEVER TYPE, PUSH TYPE, OR TURN TYPE (LATCH TYPE).
- OPENING HARDWARE IS HIGHER THAN 48" ABOVE FINISH FLOOR.
- DOOR OPERATOR SHALL BE MOUNTED SUCH THAT FROM AN OPEN POSITION OF 90 DEGREES TO 120 DEGREES THE TIME REQUIRED TO MOVE THE DOOR TO AN OPEN POSITION OF 12 DEGREES SHALL BE 5 SECONDS MINIMUM.
- HANDLES, PUSH LATCHES, KICKS AND OTHER OPERATING DEVICES ON ACCESSIBLE DOORS SHALL BE A SHAPE THAT IS EASY TO GRASP WITH ONE HAND AND DOES NOT REQUIRE TIGHT GRASPING, TIGHT PINCHING, OR TWISTING OF THE WRIST TO OPERATE. LEVER OPERATING MECHANISMS, PUSH-TYPE MECHANISMS, AND U-SHAPED HANDLES ARE ACCEPTABLE DESIGNS. WHEN SLIDING DOORS ARE FULLY OPEN OPERATING HARDWARE SHALL BE EXPOSED AND USABLE FROM BOTH SIDES. OPERATING HARDWARE FOR ACCESSIBLE DOOR PASSAGE SHALL BE MOUNTED NO HIGHER THAN 48" INCHES A.F.F.

**CLEAR SPACE AT DOORS**

- GENERAL REGARDLESS OF THE OCCUPANT LOAD, THERE SHALL BE A FLOOR OR LANDING ON EACH SIDE OF A DOOR.
- FLOOR OR LANDING ON EACH SIDE OF THE DOOR IS LEVEL AND CLEAR.
  - LEVEL AREA IN THE DIRECTION OF THE DOOR SWING IS A MINIMUM OF 60" IN LENGTH.
  - LEVEL AREA OPPOSITE THE DIRECTION OF THE DOOR SWING IS A MINIMUM OF 42-48" IN LENGTH, DEPENDING UPON DIRECTION OF APPROACH AND EXISTENCE OF LATCH AND CLOSER.
  - SURFACE SLOPE OF THE LEVEL AREA DOES NOT EXCEED 1:50 GRADIENT (2%).
  - MINIMUM STRIKE SIDE CLEARANCE ON PULL SIDE OF DOOR IS PROVIDED AT LANDING (PER 404.2.3.1).
  - MINIMUM LATCH SIDE CLEARANCE ON PUSH SIDE OF DOOR IS PROVIDED AT LANDING (PER 404.2.3.1).

**IDENTIFICATION SYMBOLS (FOR SANITARY FACILITIES)**

- THE INTERNATIONAL SYMBOL OF ACCESSIBILITY IS INSTALLED ON THE WALL ADJACENT TO THE LATCH SIDE OF THE DOOR. THE BORDER DIMENSIONS OF THIS PICTOGRAM SHALL BE A MINIMUM OF 6" IN HEIGHT.
- VERBAL DESCRIPTION AS TO RESTROOM USAGE (I.E. MEN'S RESTROOM, ECT.) IS PLACED DIRECTLY BELOW THE SYMBOL OF ACCESSIBILITY.
- THE CHARACTERS AND BACKGROUND OF THE SIGN IS EGGSHELL MATTE OR OTHER NON-GLARE FINISH AND THE COLOR AND CONTRAST OF THE SIGN DISTINCTLY CONTRASTS WITH THE COLOR AND CONTRAST OF THE WALL.

NOTE: THE REQUIRED COLOR OF THE SYMBOL OF ACCESSIBILITY CONSISTS OF A WHITE FIGURE ON A BLUE BACKGROUND. HOWEVER, THE APPROPRIATE ENFORCEMENT AGENCY MAY APPROVE SPECIAL SIGNS TO COMPLIMENT DECOR WHEN SUCH SIGNS PROVIDE ADEQUATE DIRECTION TO INDIVIDUALS WITH DISABILITIES.

- SIGNS ARE CENTERED ON THE WALL 60" A.F.F. AND 8" FROM EDGE OF SIGN TO EDGE OF DOOR FRAME.
- LETTERS AND NUMERALS ARE RAISED 1/32" ARE SANSSERIF UPPERCASE CHARACTERS AND ARE ACCOMPANIED BY GRADE 2 BRAILLE. CHARACTERS ARE A MINIMUM 5/8" HIGH AND A MAXIMUM OF 2" HIGH.
- MOUNTING LOCATION ALLOWS A PERSON TO APPROACH WITHIN 3" OF THE SIGNAGE WITHOUT ENCOUNTERING PROTRUDING OBJECTS OR STANDING WITHIN THE SWING OF A DOOR.

- SIGNS CONTAINING TACTILE CHARACTERS SHALL BE LOCATED SO THAT A CLEAR FLOOR AREA 18" X 18" MINIMUM, CENTERED ON THE TACTILE CHARACTERS, IS PROVIDED BEYOND THE ARC OF ANY DOOR SWING THE CLOSED POSITION AND 45 DEGREE OPEN POSITION.

**SANITATION FACILITIES**

- ACCESSIBLE UNITS SHALL BE IDENTIFIED BY THE INTERNATIONAL SYMBOL OF ACCESSIBILITY.
- EXCEPT AT DOORS, THE MINIMUM CLEAR WIDTH OF AN ACCESSIBLE ROUTE IN FACILITY IS 36".
- ENTRY DOOR HAS PUSH AND PULL FUNCTION (NO LATCHING DEVICE) WITH CLOSER.
- SUFFICIENT SPACE FOR WHEELCHAIR MEASURING 30" X 48" TO ENTER ROOM AND PERMIT THE DOOR TO CLOSE IS PROVIDED.
- A CLEAR SPACE OF SUFFICIENT SIZE TO INSCRIBE A 60" DIAMETER CIRCLE IS PROVIDED WITHIN THE SANITARY FACILITY ROOM.
- 60" SPACE IS CLEAR OF OBJECTS FROM THE FLOOR TO A HEIGHT OF 27".

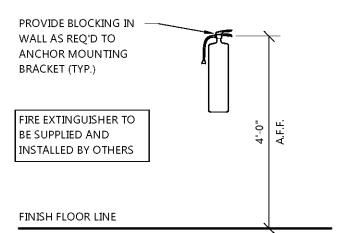

**FIRE EXTINGUISHER SPECIFICATION:**  
MANUFACTURER: JL INDUSTRIES, INC.  
PRODUCT: FIRE EXTINGUISHER  
- 'COSMIC' 10E  
10 lb. CAPACITY; 4A-80BC RATING  
BRACKET:  
- MARK 'MB846' WALL BRACKET

**7 FIRE EXTINGUISHER DETAIL**  
A5.1 SCALE: 1/2" = 1'-0"

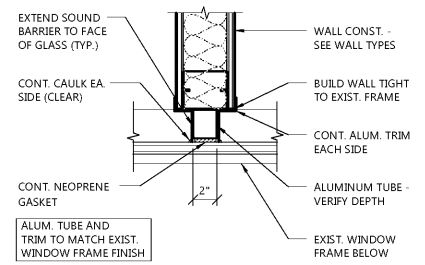

**8 WALL CLOSURE DETAIL**  
A5.1 NOT TO SCALE

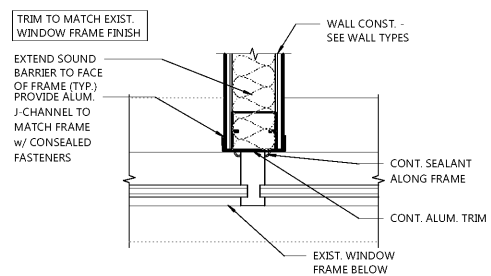

**9 WALL CLOSURE DETAIL**  
A5.1 NOT TO SCALE

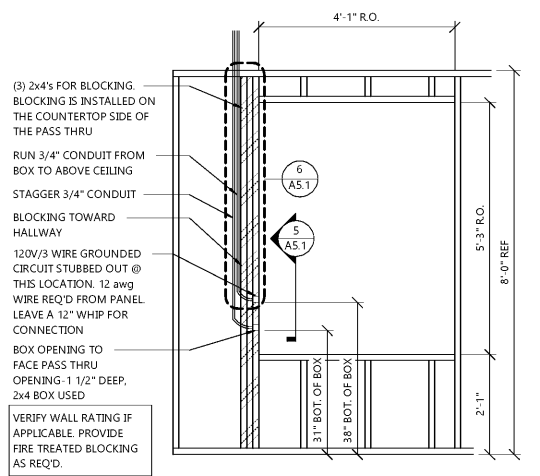

**4 PASS THRU X-RAY**  
A5.1 NOT TO SCALE

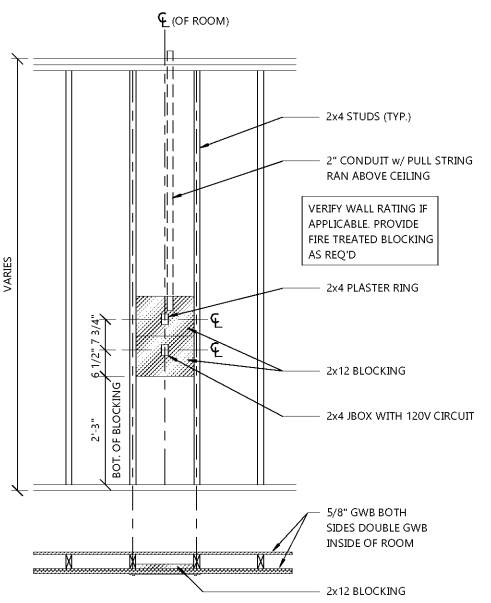

**1 CS 2200 X-RAY SUPPORT**  
A5.1 NOT TO SCALE

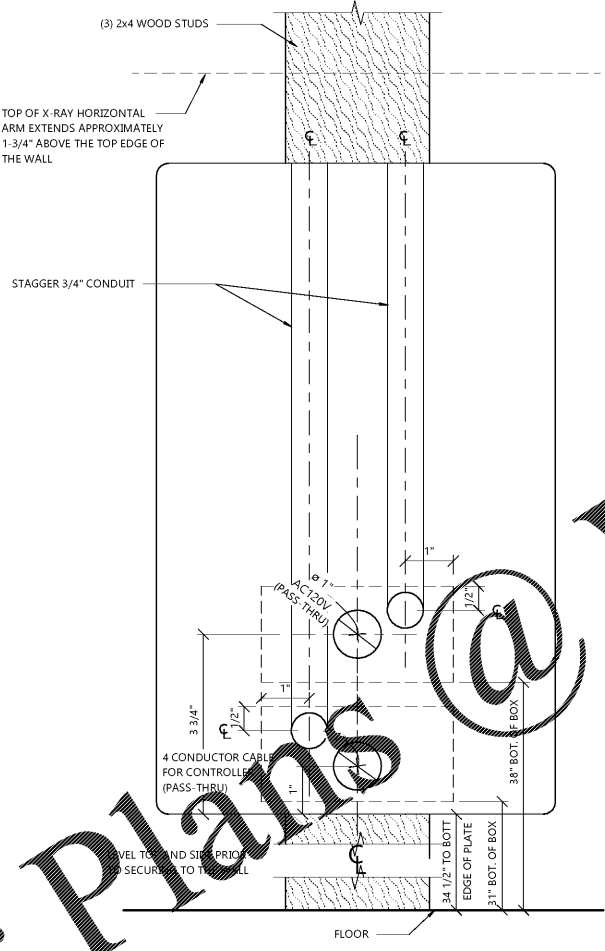

**5 PASS THRU X-RAY PLATE DETAIL**  
A5.1 NOT TO SCALE

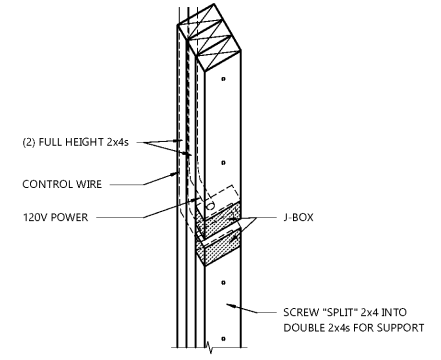

**6 PASS THRU X-RAY ISOMETRIC**  
A5.1 NOT TO SCALE

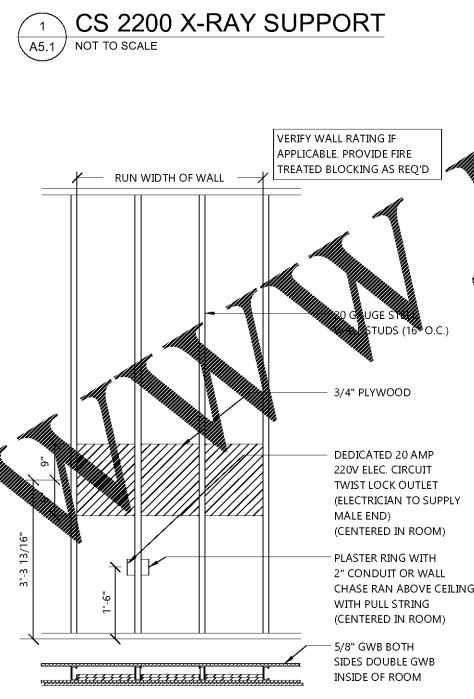

**2 PANORAMIC X-RAY SUPPORT**  
A5.1 NOT TO SCALE

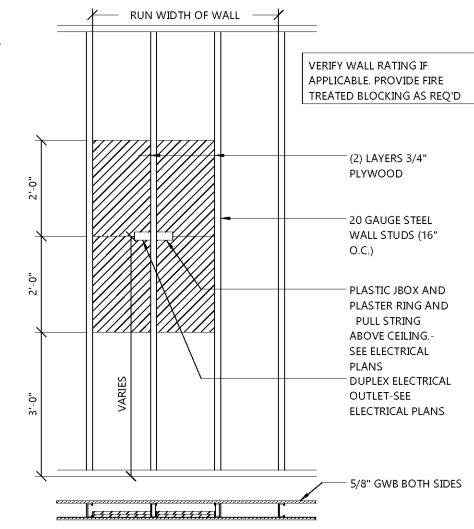

**3 PLASMA TV SUPPORT**  
A5.1 SCALE: 1/2" = 1'-0"

Order Plans @