

COPYRIGHT NOTICE
THIS DRAWING IS THE PROPERTY OF TEXAS ROADHOUSE INC. AND IS NOT TO BE USED FOR ANY PURPOSE OTHER THAN THE SPECIFIC PROJECT AND SITE NAMED HEREIN, AND CANNOT BE REPRODUCED IN ANY MANNER WITHOUT THE EXPRESS WRITTEN PERMISSION FROM TEXAS ROADHOUSE INC.



PERMIT/BID SET
05.03.2019

DRAWN BY: KMS
CHECKED BY:
REVISIONS: 1

THE CONSTRUCTION DOCUMENTS SHALL CONSIST OF ALL DRAWINGS, SPECIFICATIONS, SURVEYS, SOIL REPORTS, ADDENDUMS AND OTHER DOCUMENTS REFERENCED HEREIN. THESE DOCUMENTS SHALL BE TAKEN SEPARATELY OR IN WHOLE. NONE OF THIS INFORMATION OR DRAWING SHEETS SHALL BE TAKEN SEPARATELY OR IN WHOLE FROM THE REMAINDER OF THE CONSTRUCTION DOCUMENTS. THE ARCHITECT SHALL BE RESPONSIBLE TO DETERMINE THE PARTICULAR SCOPE OF WORK. ANY CHANGES TO THE CONSTRUCTION DOCUMENTS SHALL BE THE RESPONSIBILITY OF THE ARCHITECT PRIOR TO SUBMITTING A BID. THIS SHALL BE INTERPRETED AT THE SOLE DISCRETION OF THE ARCHITECT.

SHEET TITLE
INTERIOR ELEVATIONS

SHEET #
FS-5.0

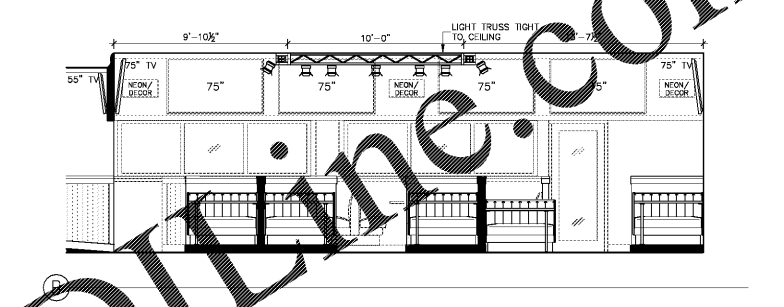
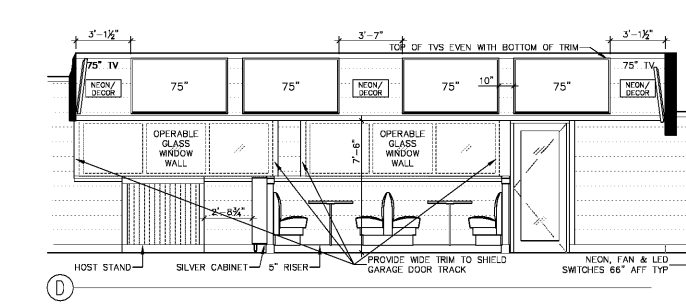
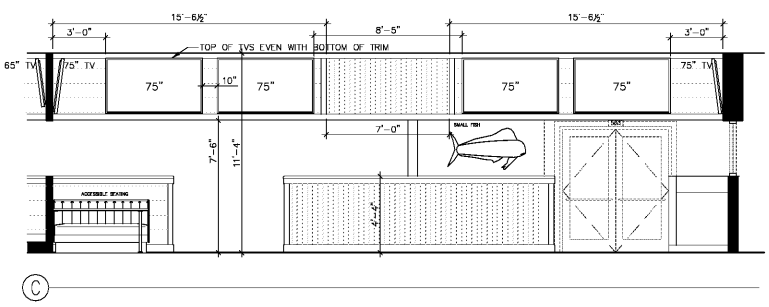
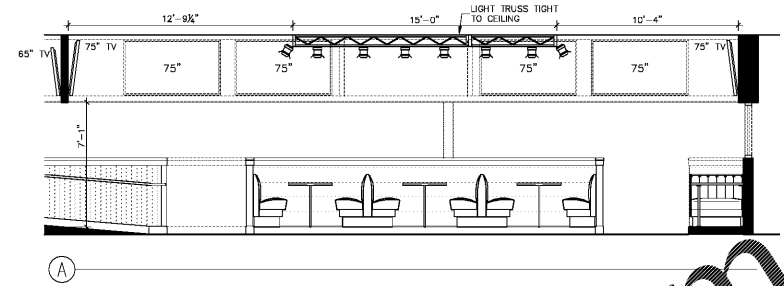
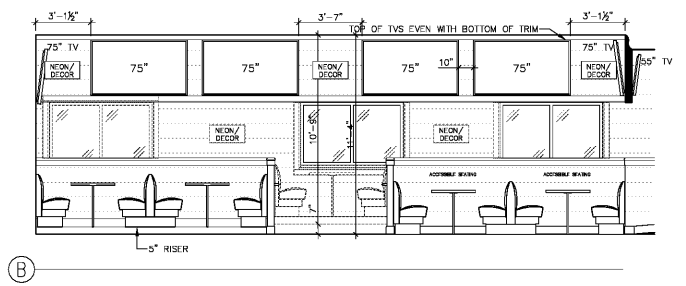
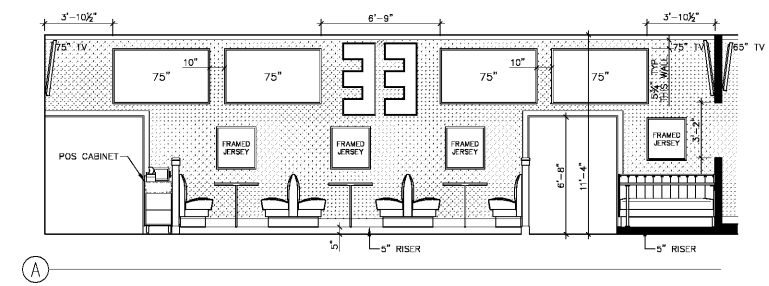

MAIN DINING ROOM ELEVATIONS
SCALE: 1/4" = 1'-0"

MAIN DINING ROOM SEATING ISLAND ELEVATION/SECTION
SCALE: 1/4" = 1'-0"

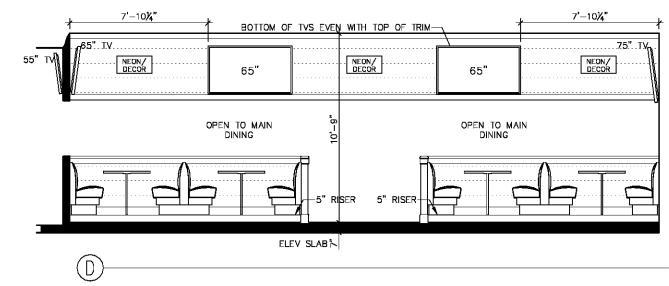
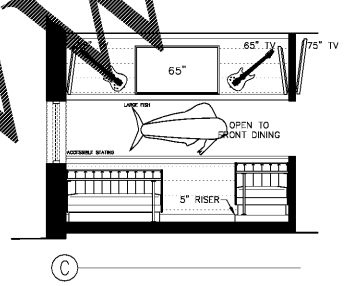
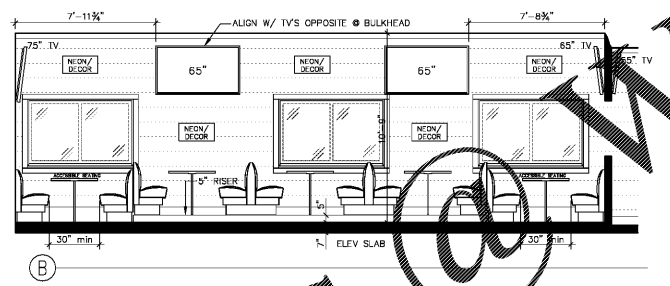
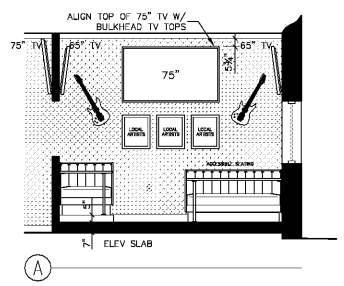

ELEVATED SIDE DINING ROOM ELEVATIONS
SCALE: 1/4" = 1'-0"

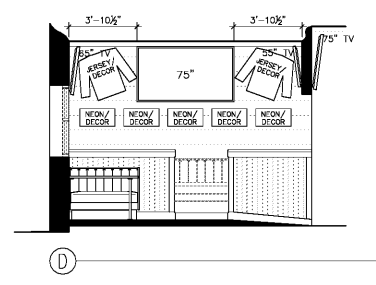
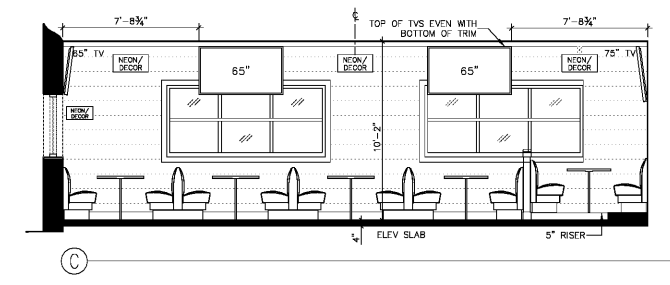
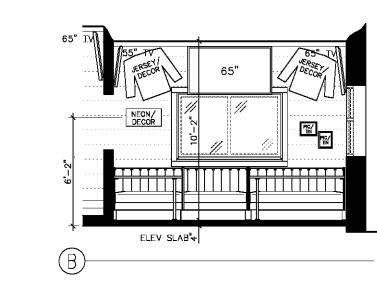
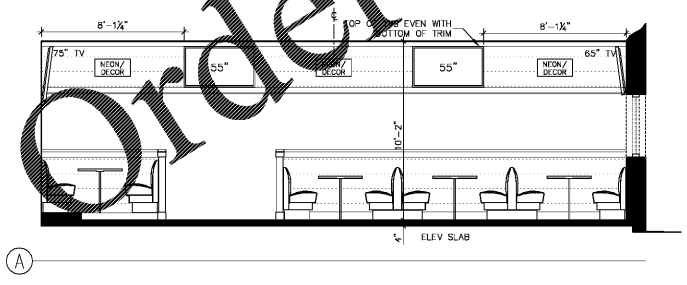

ELEVATED FRONT DINING ROOM ELEVATIONS
SCALE: 1/4" = 1'-0"