

COPYRIGHT NOTICE
THIS DRAWING IS THE PROPERTY OF TEXAS ROADHOUSE INC. AND IS NOT TO BE USED FOR ANY PURPOSE OTHER THAN THE SPECIFIC PROJECT AND SITE NAMED HEREIN, AND CANNOT BE REPRODUCED IN ANY MANNER WITHOUT THE EXPRESS WRITTEN PERMISSION FROM TEXAS ROADHOUSE INC.



PERMIT/BID SET
05.03.2019

DRAWN BY: KMS
CHECKED BY:
REVISIONS: 1

THE CONSTRUCTION DOCUMENTS SHALL CONSIST OF ALL DRAWINGS, SPECIFICATIONS, SURVEYS, SOIL REPORTS, ADDENDA AND OTHER DOCUMENTS REFERENCED HEREIN. THE CONTRACTOR SHALL BE RESPONSIBLE FOR OBTAINING ALL NECESSARY PERMITS AND FOR VERIFYING THE ACCURACY OF ALL INFORMATION PROVIDED. THE CONTRACTOR SHALL BE RESPONSIBLE FOR OBTAINING ALL NECESSARY PERMITS AND FOR VERIFYING THE ACCURACY OF ALL INFORMATION PROVIDED. THE CONTRACTOR SHALL BE RESPONSIBLE FOR OBTAINING ALL NECESSARY PERMITS AND FOR VERIFYING THE ACCURACY OF ALL INFORMATION PROVIDED.

SHEET TITLE
EQUIPMENT ELEVATIONS

SHEET #
EQ-3.2

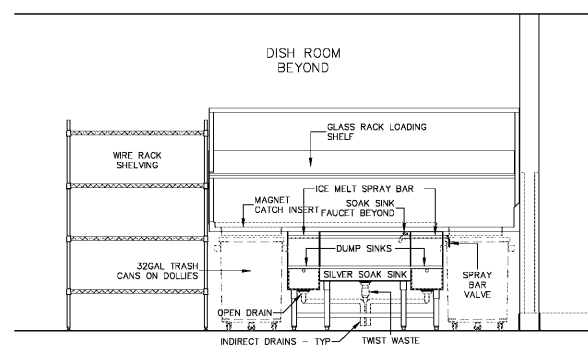

DISH MUCK STATION ELEVATION
SCALE: 3/4" = 1'-0"

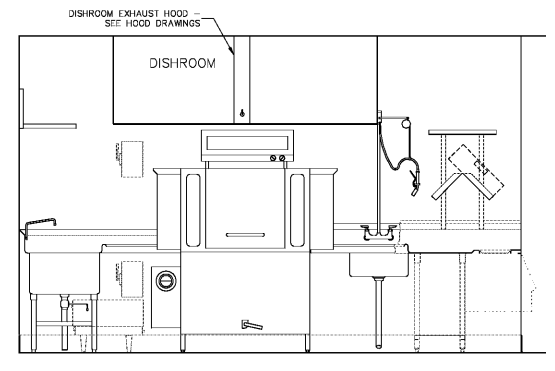

DISH OPERATOR STATION ELEVATION
SCALE: 3/4" = 1'-0"

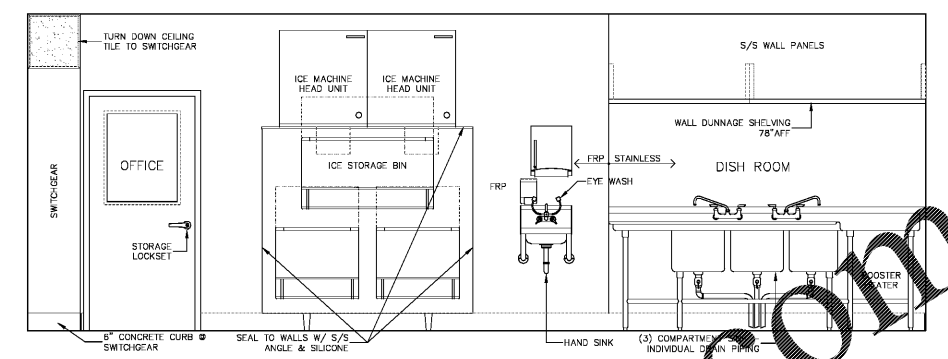

DISH ROOM/SERVICE ENTRY ELEVATION
SCALE: 3/4" = 1'-0"

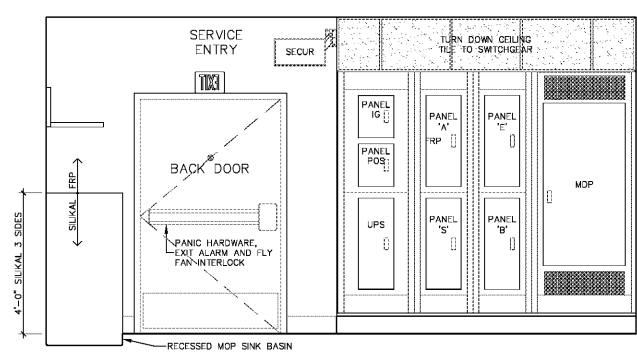

SERVICE ENTRY ELEVATION
SCALE: 3/4" = 1'-0"

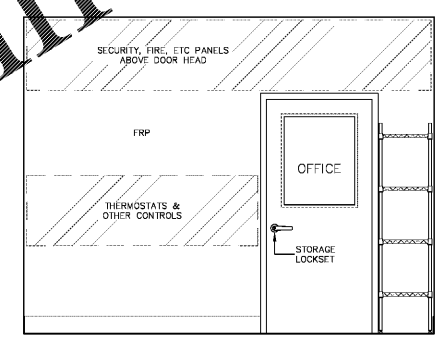
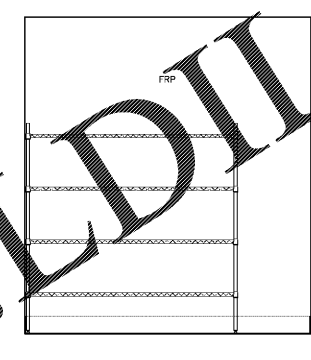
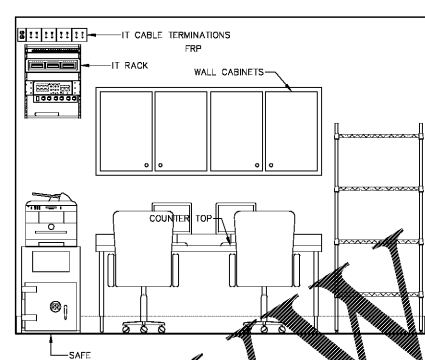
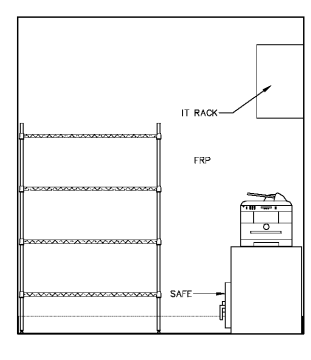

OFFICE ELEVATIONS
SCALE: 3/4" = 1'-0"

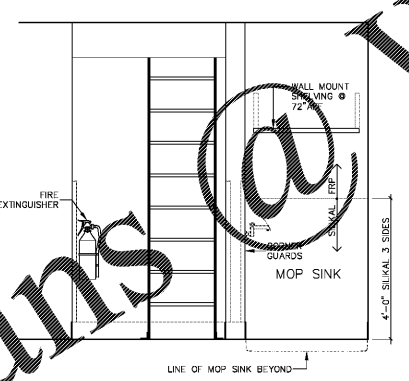

MOP SINK ELEVATION
SCALE: 3/4" = 1'-0"

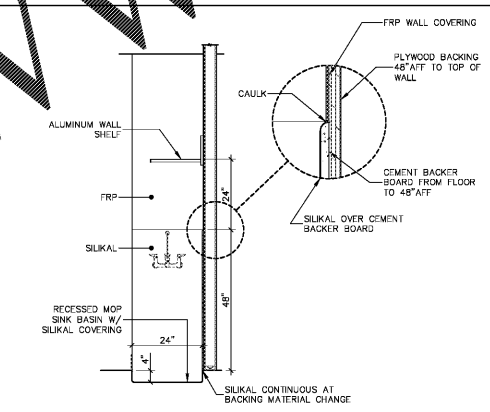

MOP SINK DETAIL
SCALE: 3/4" = 1'-0"

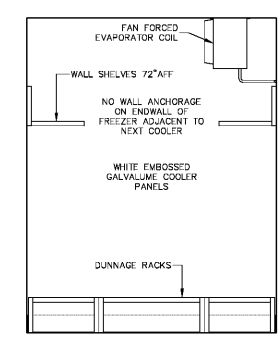
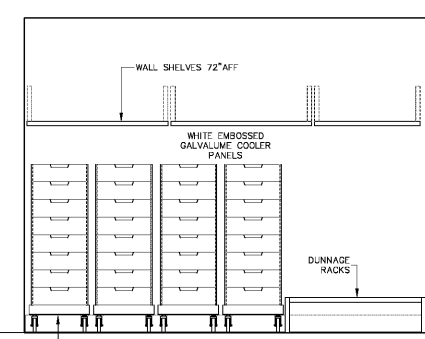
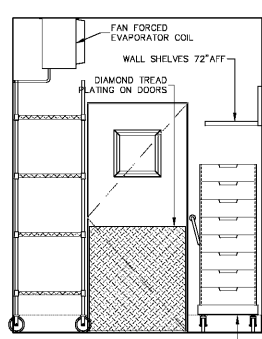
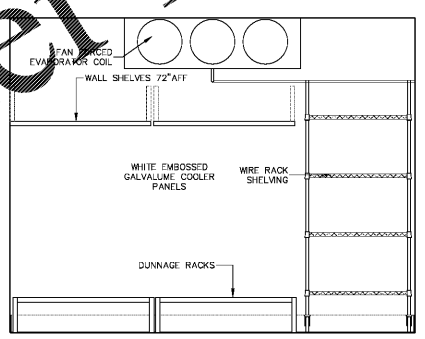

FREEZER ELEVATIONS
SCALE: 3/4" = 1'-0"