

222 cloister court
 chapel hill, nc 27514
 919.401.8586
 www.cra-nc.com

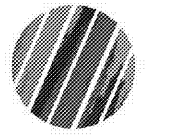

Cedar Ridge High School
 Classroom Addition
 Orange County Schools
 1125 New Grady Brown School Road
 Hillsborough, North Carolina



no. revisions

The use of these plans and specifications shall be restricted to the original site for which they were prepared and no other use without the express written consent of the architect. No part of these plans and specifications shall be reproduced or transmitted in any form or by any means, electronic, mechanical, photocopying, recording, or by any information storage and retrieval system, without the prior written permission of the architect.

drawn [] checked []
 date [] [] []

Door Details

sheet

A8.1

project no. 1716

date 4/25/19

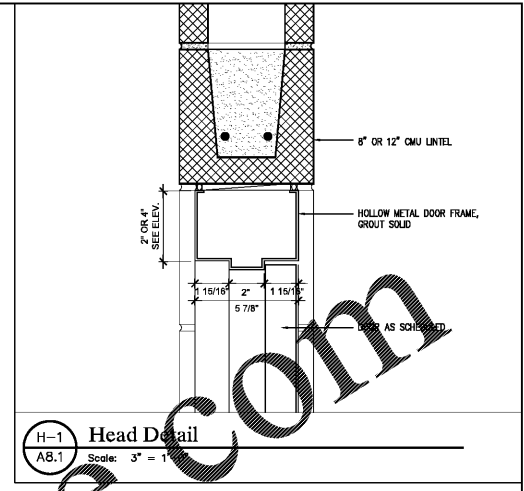

H-1 Head Detail
 AB.1 Scale: 3\"/>

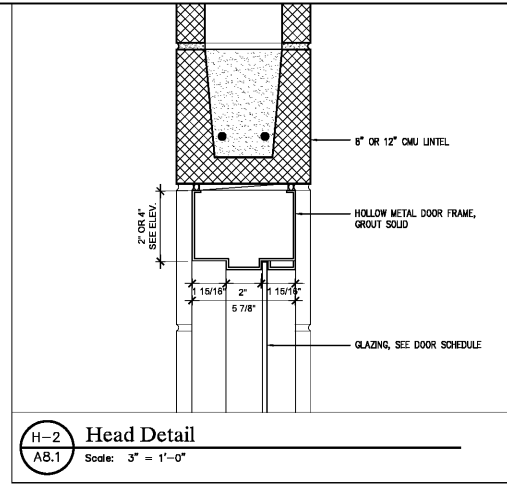

H-2 Head Detail
 AB.1 Scale: 3\"/>

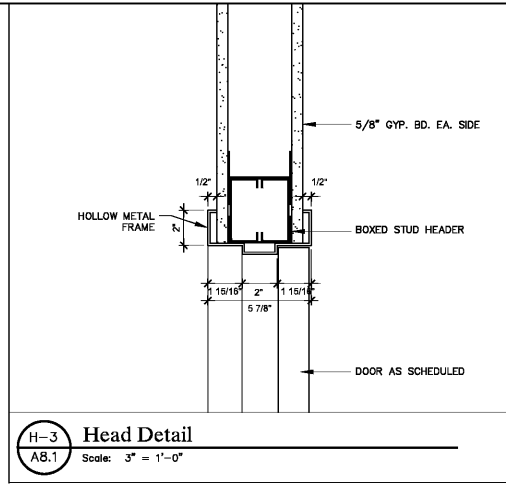

H-3 Head Detail
 AB.1 Scale: 3\"/>

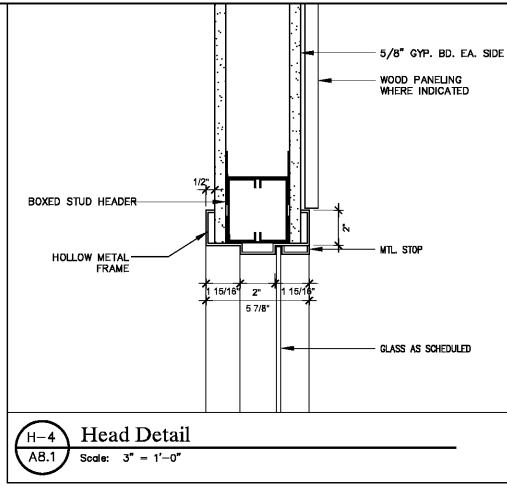

H-4 Head Detail
 AB.1 Scale: 3\"/>

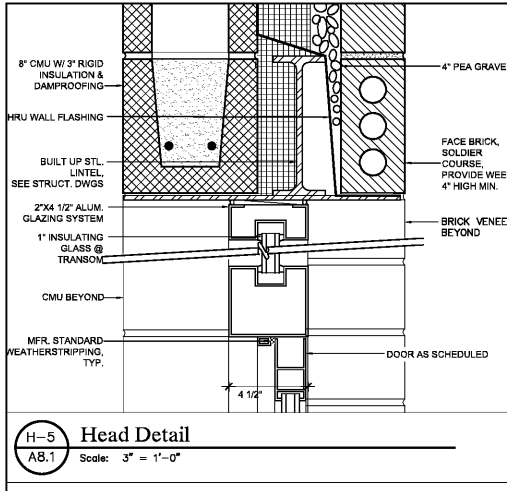

H-5 Head Detail
 AB.1 Scale: 3\"/>

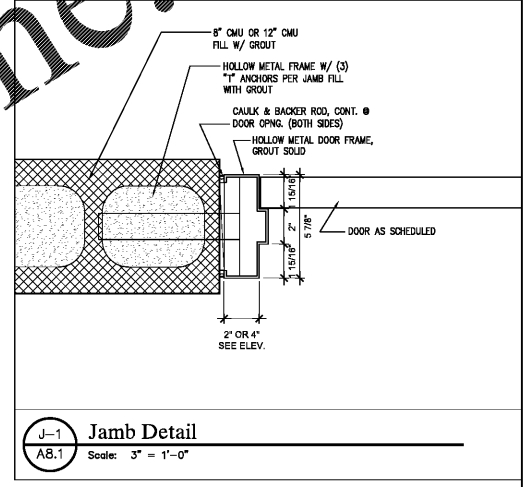

J-1 Jamb Detail
 AB.1 Scale: 3\"/>

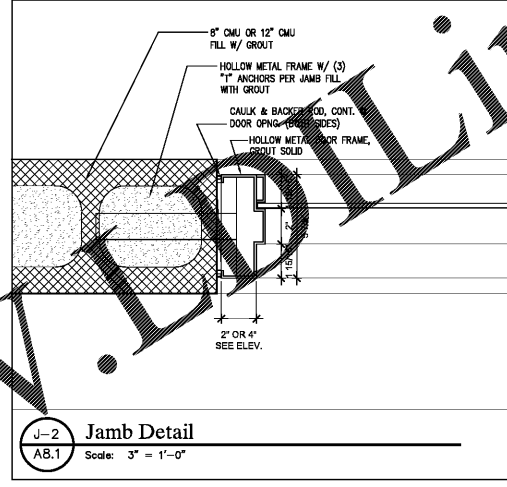

J-2 Jamb Detail
 AB.1 Scale: 3\"/>

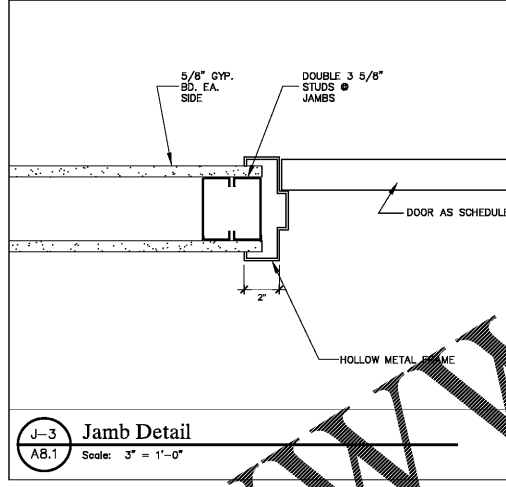

J-3 Jamb Detail
 AB.1 Scale: 3\"/>

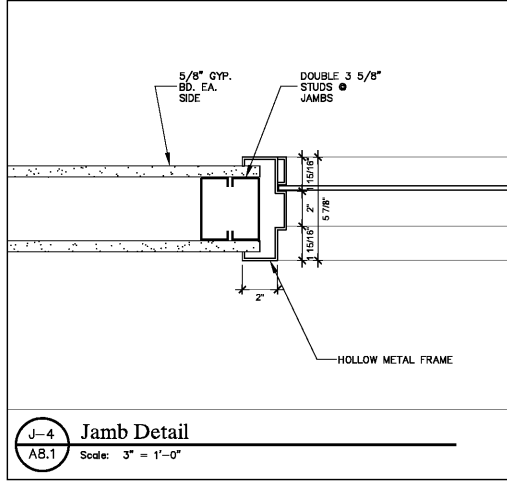

J-4 Jamb Detail
 AB.1 Scale: 3\"/>

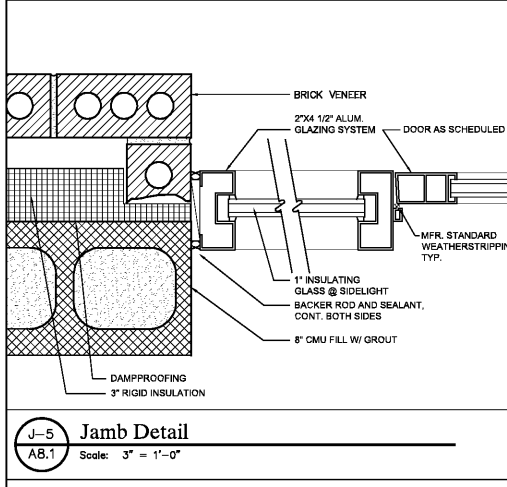

J-5 Jamb Detail
 AB.1 Scale: 3\"/>

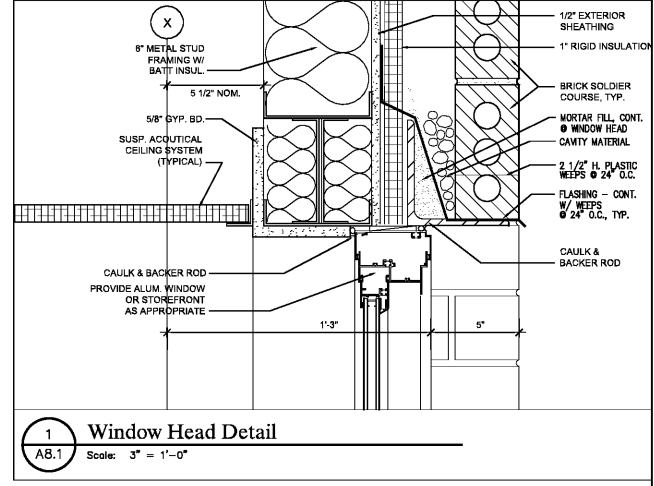

1 Window Head Detail
 AB.1 Scale: 3\"/>

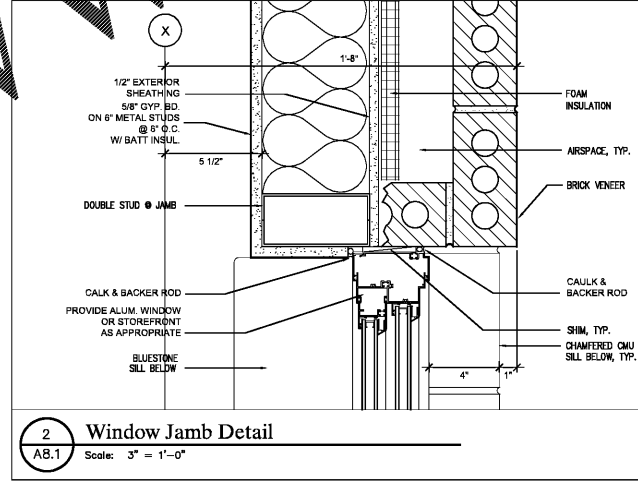

2 Window Jamb Detail
 AB.1 Scale: 3\"/>

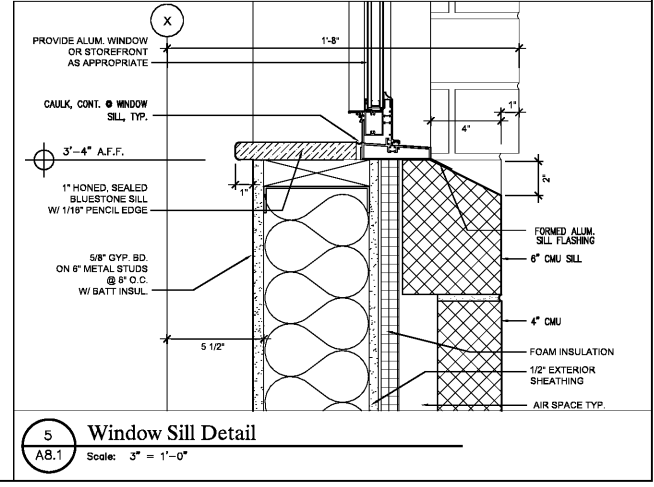

5 Window Sill Detail
 AB.1 Scale: 3\"/>

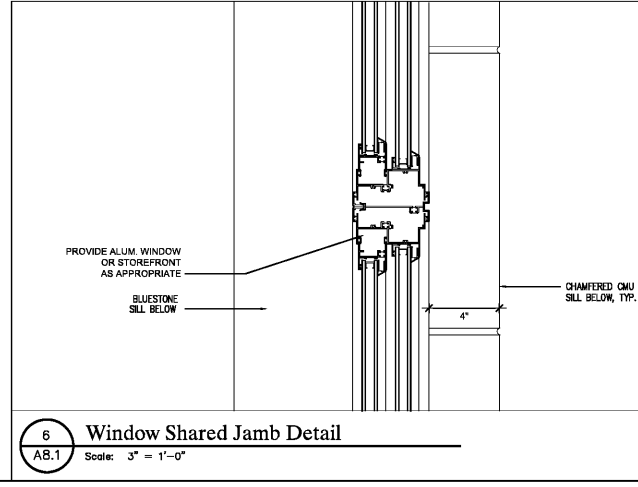

6 Window Shared Jamb Detail
 AB.1 Scale: 3\"/>

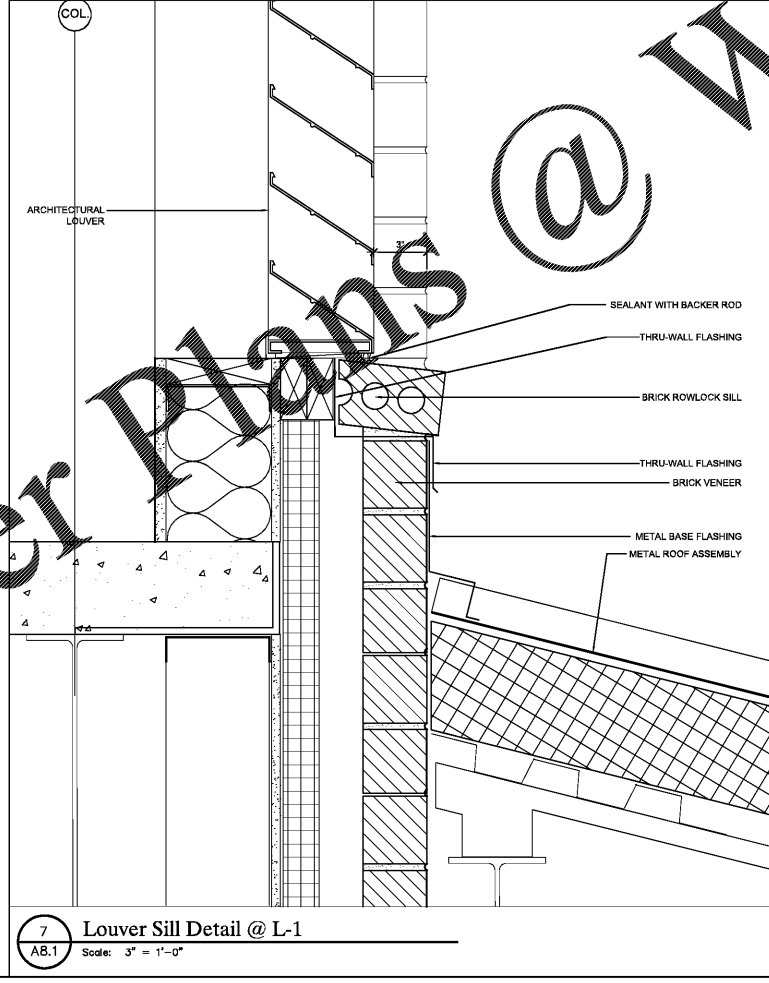

7 Louver Sill Detail @ L-1
 AB.1 Scale: 3\"/>

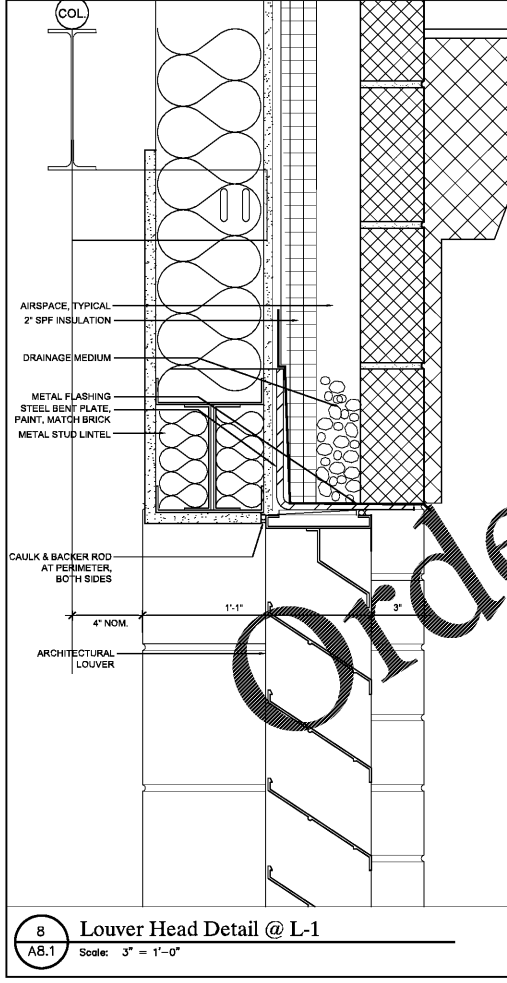

8 Louver Head Detail @ L-1
 AB.1 Scale: 3\"/>

Order Plans @ www.IDBLine.com