

6 RESTROOM SIGNAGE
AC1 3" = 1'-0"

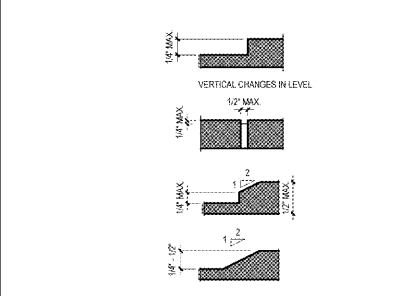

5 CHANGES IN LEVEL
AC1 1" = 1'-0"

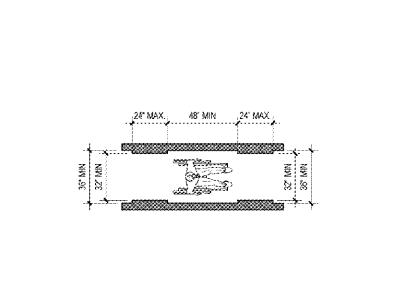

4 CLEAR WIDTH - ACCESSIBLE ROUTE
AC1 1/4" = 1'-0"

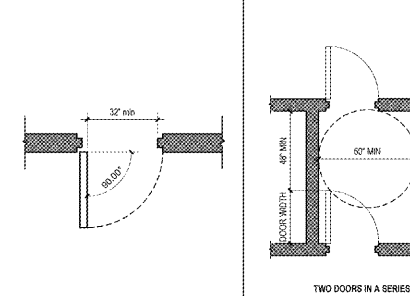

3 CLEAR WIDTH HINGED DOOR
AC1 3/8" = 1'-0"

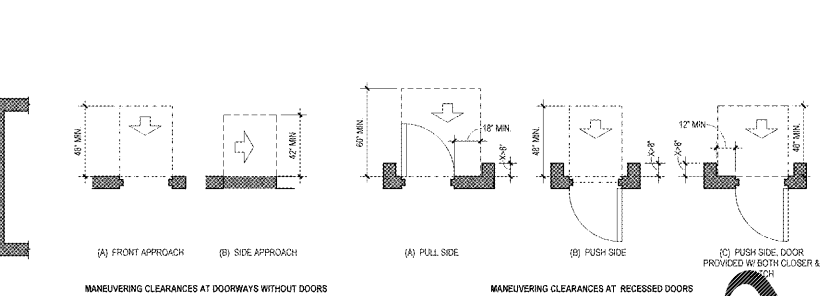

8 MANEUVERING CLEARANCE AT DOORS AND DOORWAYS
AC1 1/4" = 1'-0"

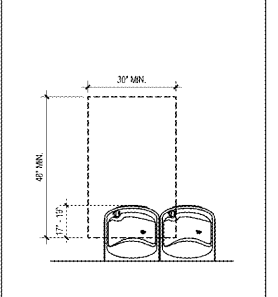

1 DRINKING FOUNTAIN PLAN
AC1 1/2" = 1'-0"

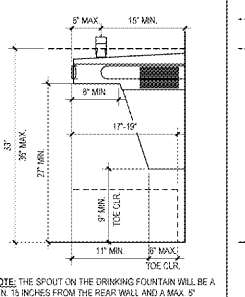

11 DRINKING FOUNTAIN SECTION
AC1 1" = 1'-0"

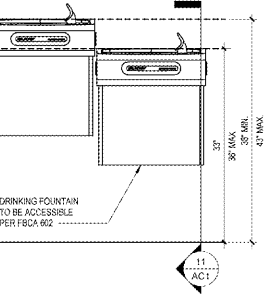

10 DRINKING FOUNTAIN ELEVATION
AC1 1" = 1'-0"

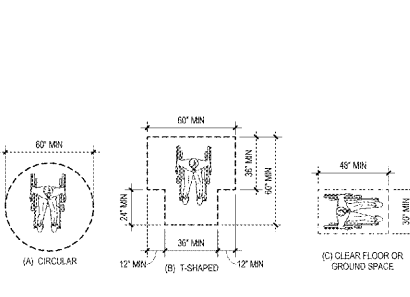

9 CLEAR TURNING SPACE
AC1 1/4" = 1'-0"

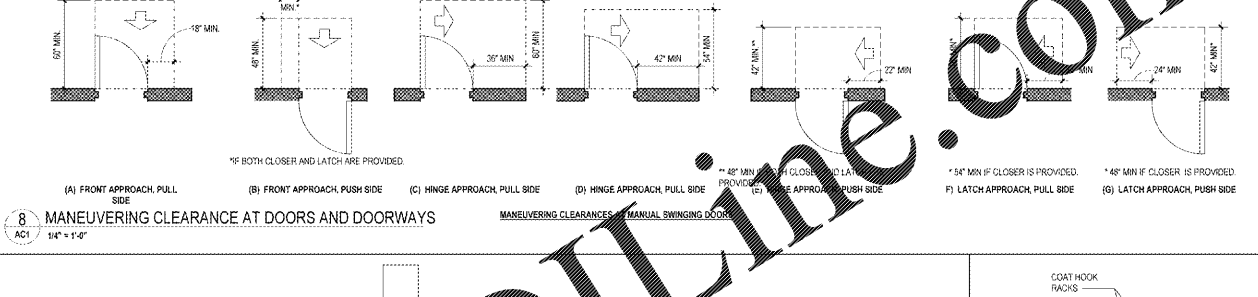

15 EQUIPMENT & COUNTERS ELEVATIONS
AC1 1/4" = 1'-0"

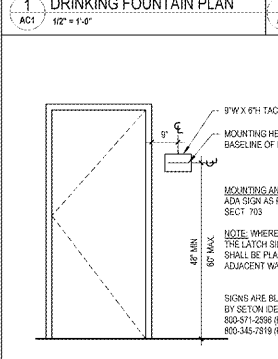

18 TACTILE EXIT SIGNAGE MOUNTING
AC1 1/2" = 1'-0"

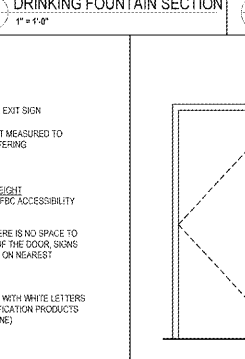

17 SIGNAGE MOUNTING HEIGHT
AC1 1/2" = 1'-0"

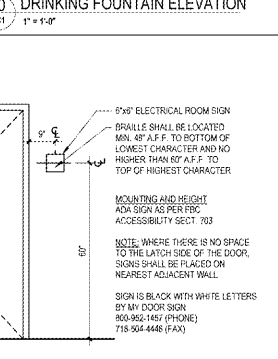

9 CLEAR TURNING SPACE
AC1 1/4" = 1'-0"

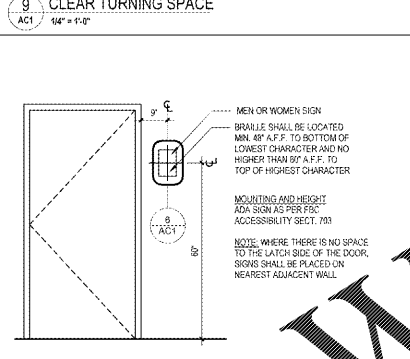

9 CLEAR TURNING SPACE
AC1 1/4" = 1'-0"

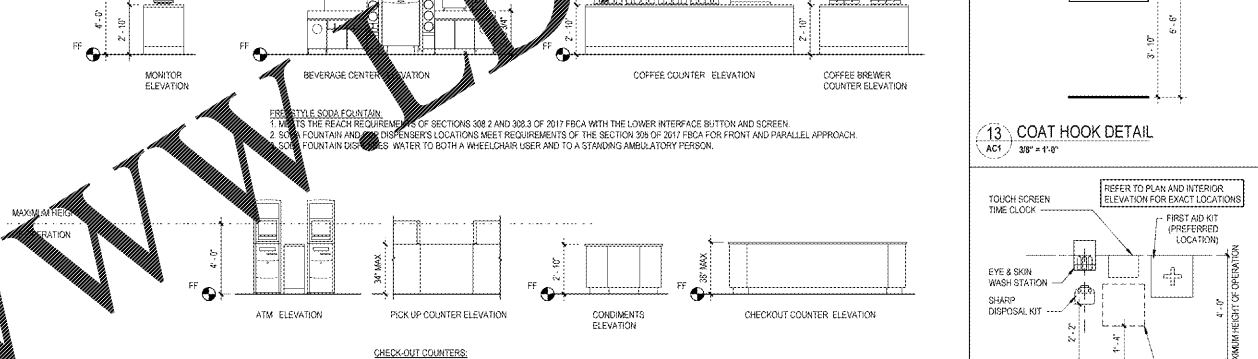

13 COAT HOOK DETAIL
AC1 3/8" = 1'-0"

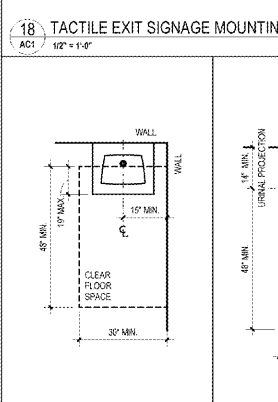

24 ACCESSIBLE LAV. PLAN
AC1 1/2" = 1'-0"

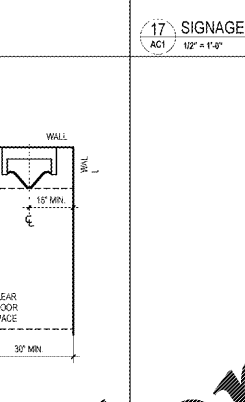

23 ACCESSIBLE URN. PLAN
AC1 1/2" = 1'-0"

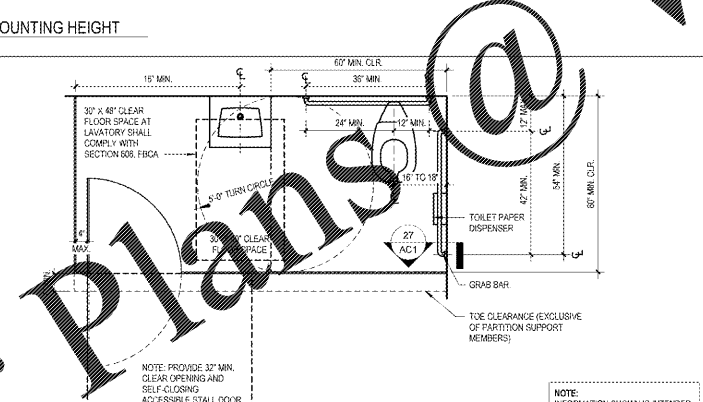

22 ACCESSIBLE WATER CLOSET - PLAN
AC1 1/2" = 1'-0"

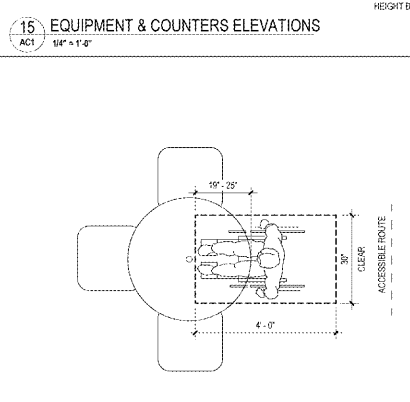

21 SEATING CLEARANCES
AC1 1/2" = 1'-0"

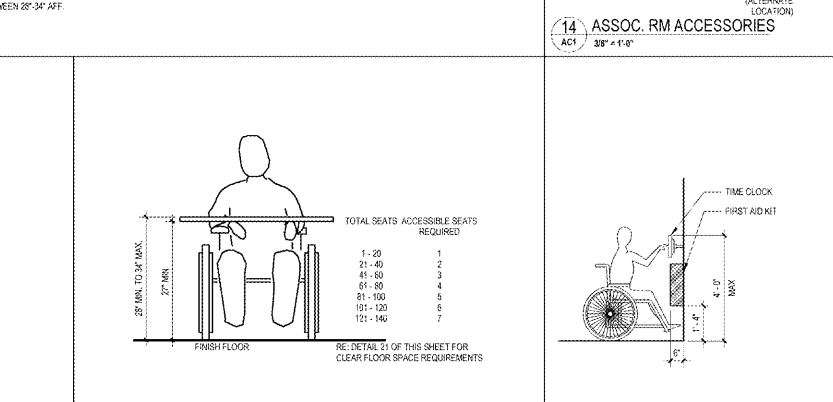

20 SEATING CLEARANCE - FRONT
AC1 3/8" = 1'-0"

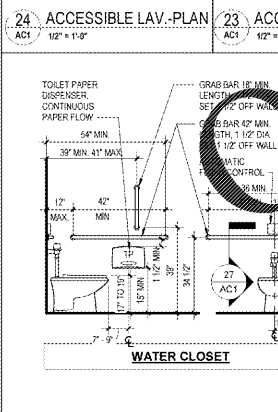

30 ACCESSIBILITY - RESTROOMS BARRIER FREE ELEVATIONS
AC1 3/8" = 1'-0"

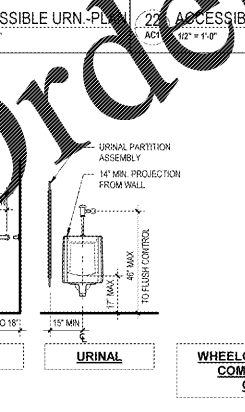

19 TIME CLOCK ACCESSIBLE REACH
AC1 3/8" = 1'-0"

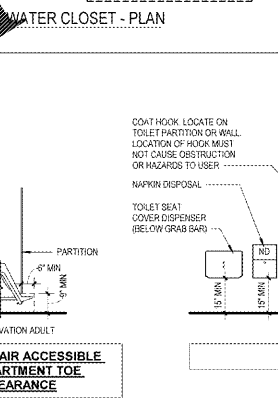

25 ACCESSIBLE REACH
AC1 1/4" = 1'-0"

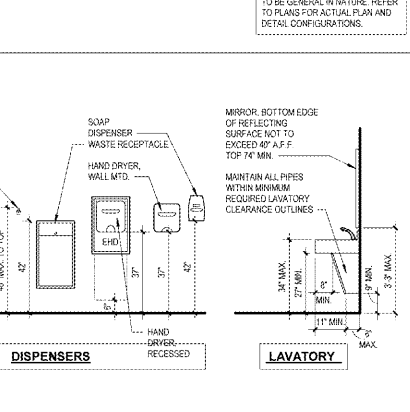

27 GRAB BAR DETAIL
AC1 5" = 1'-0"

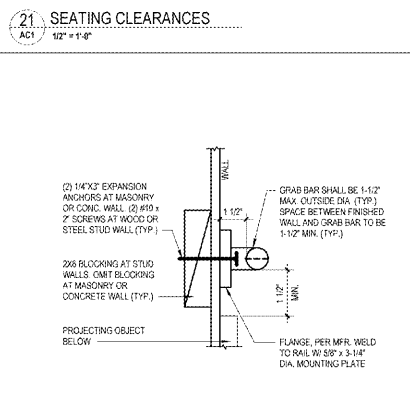

26 PROTRUDING OBJECTS
AC1 1/4" = 1'-0"

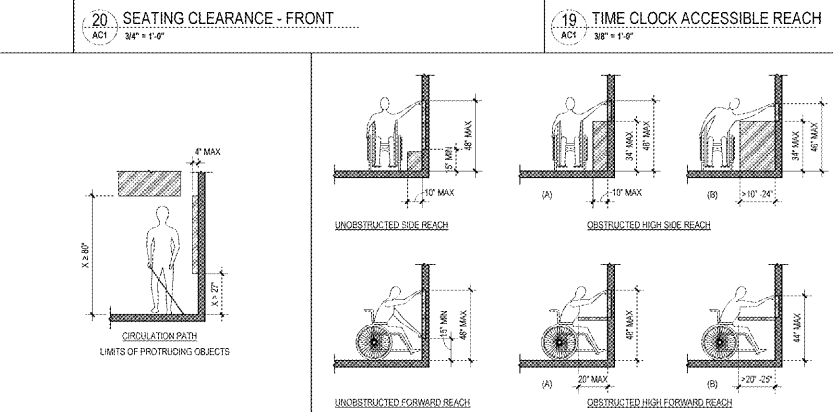

25 ACCESSIBLE REACH
AC1 1/4" = 1'-0"

Order Plans @ www.dline.com

1925 Prospect Ave.
Orlando, FL 32814
P (407) 661-9100
F (407) 661-9101
www.dp.com



CLIENT NAME
WAWA
260 WEST BALTIMORE PIKE
WAWA, PENNSYLVANIA 15063

PROJECT NAME
WAWA F85FB 2019.01 STORE #5357-DOR
NW 87TH AVE. & NW 33RD ST.
DORAL, FLORIDA

SHEET TITLE
ACCESSIBILITY DETAILS

Revision Schedule	Date
No.	Description
1	PRELIMINARY
2	PRELIMINARY
3	PRELIMINARY
4	PRELIMINARY
5	PRELIMINARY
6	PRELIMINARY
7	PRELIMINARY
8	PRELIMINARY
9	PRELIMINARY
10	PRELIMINARY
11	PRELIMINARY
12	PRELIMINARY
13	PRELIMINARY
14	PRELIMINARY
15	PRELIMINARY
16	PRELIMINARY
17	PRELIMINARY
18	PRELIMINARY
19	PRELIMINARY
20	PRELIMINARY
21	PRELIMINARY
22	PRELIMINARY
23	PRELIMINARY
24	PRELIMINARY
25	PRELIMINARY
26	PRELIMINARY
27	PRELIMINARY
28	PRELIMINARY
29	PRELIMINARY
30	PRELIMINARY

PROJECT NO.
271168
DATE
08-03-2018
DRAWN
JL
CHECKED
DU

AC1