

FIG. 403.5.1 CLEAR WIDTH AT 180° TURN

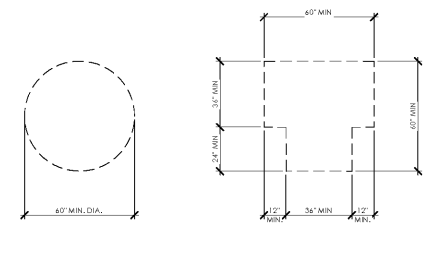

FIG. 504.3 SIZE OF TURNING SPACE

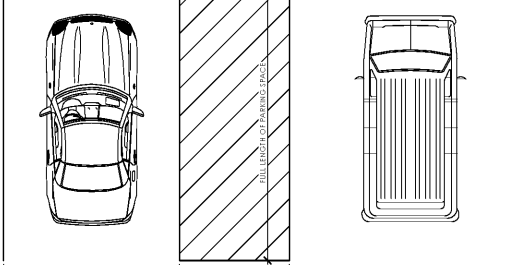
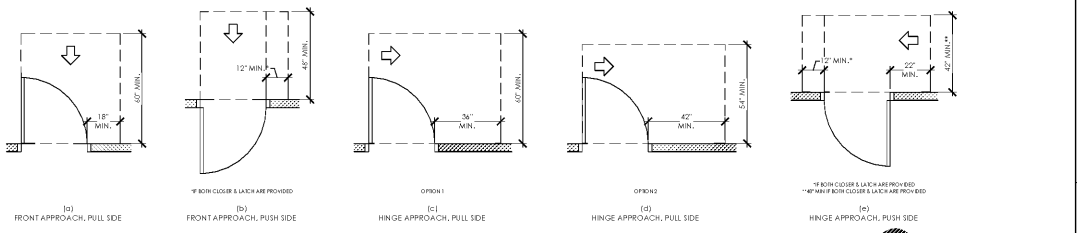

FIG. 502.2 VEHICLE PARKING SPACE SIZE



DOOR CLEARANCES

SCALE NOT TO SCALE 8

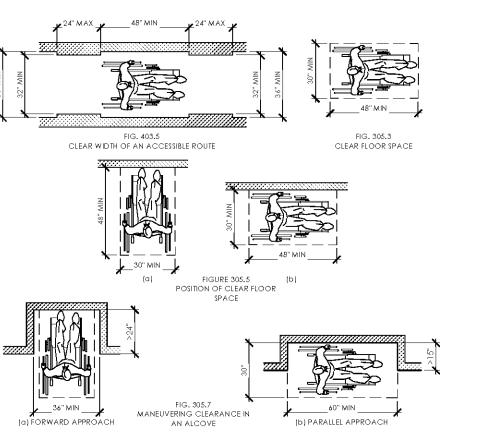

FIG. 403.5 CLEAR WIDTH OF AN ACCESSIBLE ROUTE

FIG. 403.6 CLEAR FLOOR SPACE

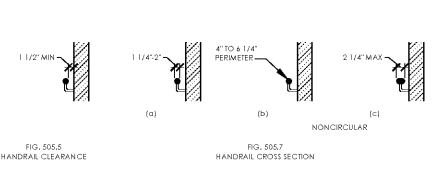

FIG. 505.6 HANDRAIL CLEARANCE

FIG. 505.7 HANDRAIL CROSS SECTION

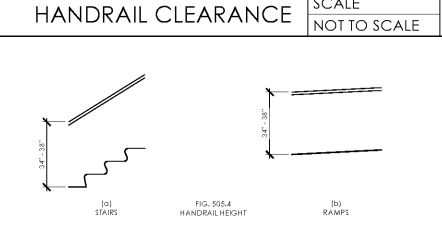

FIG. 505.4 HANDRAIL HEIGHT

FIG. 505.5 RAMP

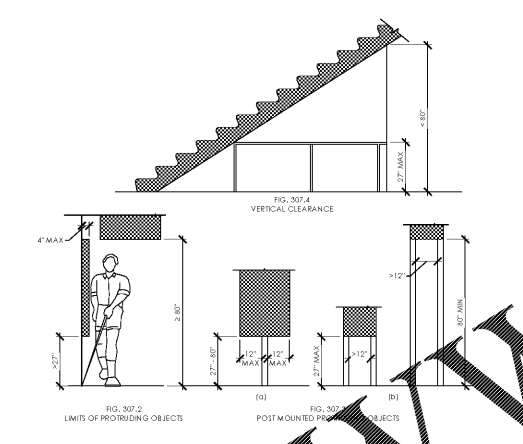
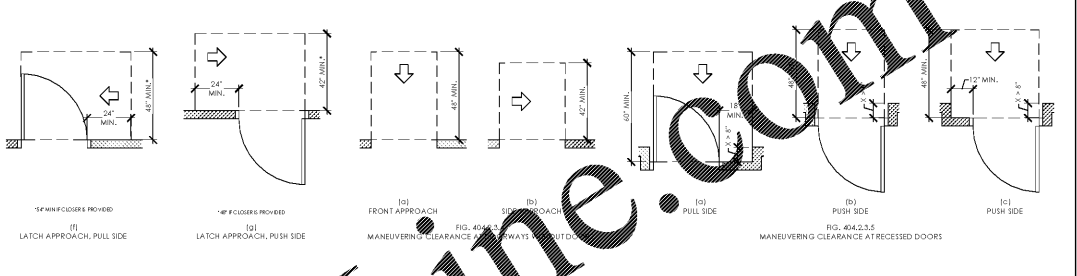

FIG. 307.4 VERTICAL CLEARANCE

FIG. 302.2 LIMITS OF PROTRUDING OBJECTS

FIG. 302.3 POST MOUNTED PROTRUDING OBJECTS



DOOR CLEARANCES

SCALE NOT TO SCALE 8

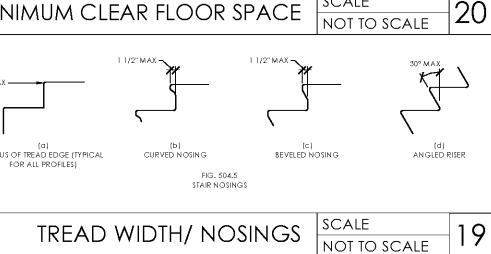

MINIMUM CLEAR FLOOR SPACE

SCALE NOT TO SCALE 20

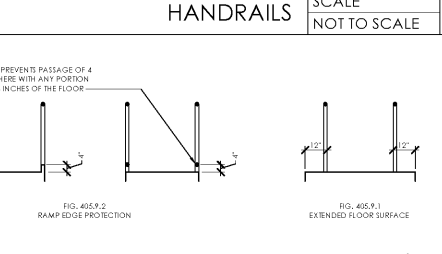

HANDRAILS

SCALE NOT TO SCALE 14

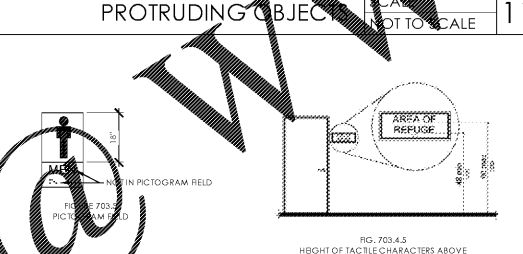

PROTRUDING OBJECTS

SCALE NOT TO SCALE 11

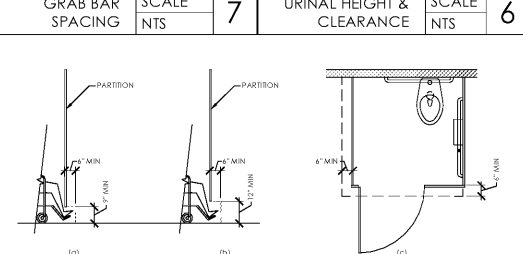

GRAB BAR SPACING

SCALE NTS 7

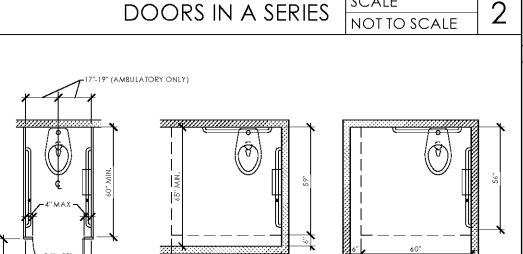

DOORS IN A SERIES

SCALE NOT TO SCALE 2

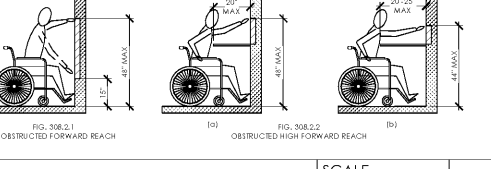

TREAD WIDTH/ NOSINGS

SCALE NOT TO SCALE 19

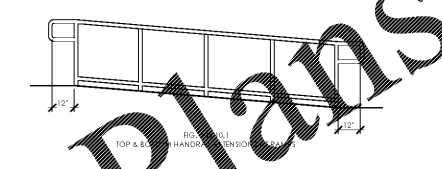

FIG. 405.9.2 RAMP EDGE PROJECTION

FIG. 405.9.1 EXTENDED FLOOR SURFACE

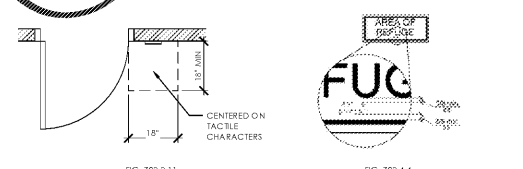

FIG. 703.2 PICTOGRAM FIELD

FIG. 703.4.5 HEIGHT OF TACTILE CHARACTERS ABOVE FINISH FLOOR OR GROUND

FIG. 703.3.1 LOCATION OF SIGNS AT DOORS

FIG. 703.4.4 POSITION OF BRAILLE



WHEELCHAIR TOE CLEARANCE

SCALE NOT TO SCALE 5

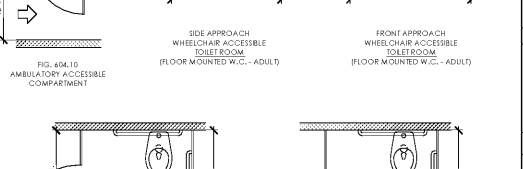
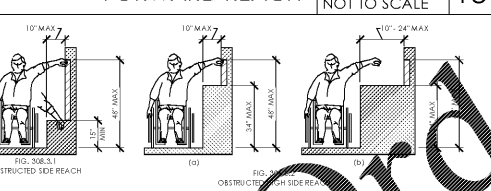

FIG. 404.10 AMBULATORY ACCESSIBLE COMPARTMENT

FIG. 404.9.2 SIDE APPROACH WHEELCHAIR ACCESSIBLE TOILET ROOM (FLOOR MOUNTED W.C. - ADULT)

FIG. 404.9.1 FRONT APPROACH WHEELCHAIR ACCESSIBLE TOILET ROOM (FLOOR MOUNTED W.C. - ADULT)



FORWARD REACH

SCALE NOT TO SCALE 18

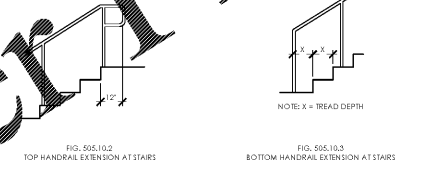

FIG. 505.10.2 TOP HANDRAIL EXTENSION AT STAIRS

FIG. 505.10.3 BOTTOM HANDRAIL EXTENSION AT STAIRS



TACTILE SIGNS

SCALE NOT TO SCALE 10

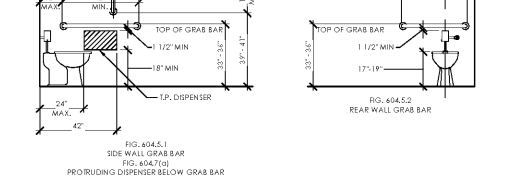

GRAB BAR & PROTRUDING DISPENSER @ WATER CLOSET

SCALE NOT TO SCALE 4

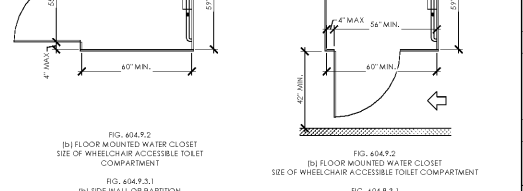
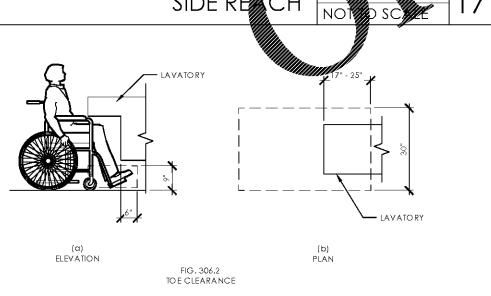

FIG. 404.9.2 (B) FLOOR MOUNTED WATER CLOSET SIZE OF WHEELCHAIR ACCESSIBLE TOILET ROOM

FIG. 404.9.2 (C) FLOOR MOUNTED WATER CLOSET SIZE OF WHEELCHAIR ACCESSIBLE TOILET ROOM

FIG. 404.9.1 (B) SIDE WALL OF PARTITION WHEELCHAIR ACCESSIBLE COMPARTMENT DOOR OPENINGS

FIG. 404.9.1 (C) FRONT PARTITION WHEELCHAIR ACCESSIBLE COMPARTMENT DOOR OPENINGS



SIDE REACH

SCALE NOT TO SCALE 17

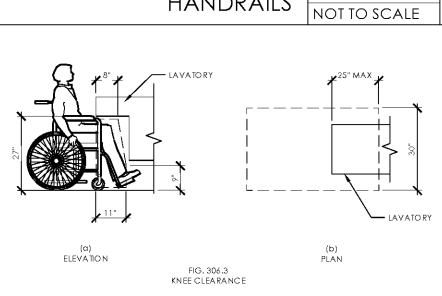

HANDRAILS

SCALE NOT TO SCALE 13

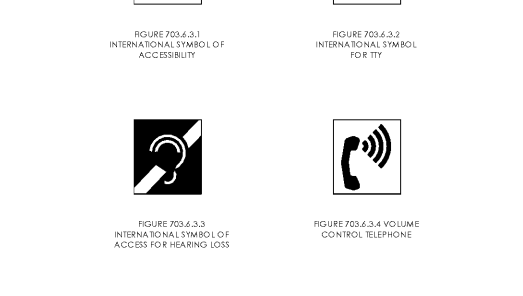

FIGURE 703.4.3.1 INTERNATIONAL SYMBOL OF ACCESSIBILITY

FIGURE 703.4.3.2 INTERNATIONAL SYMBOL FOR TTY

FIGURE 703.4.3.3 INTERNATIONAL SYMBOL OF ACCESS FOR HEARING LOSS

FIGURE 703.4.3.4 VOLUME CONTROL TELEPHONE

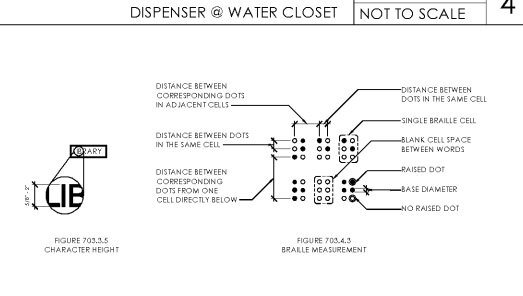
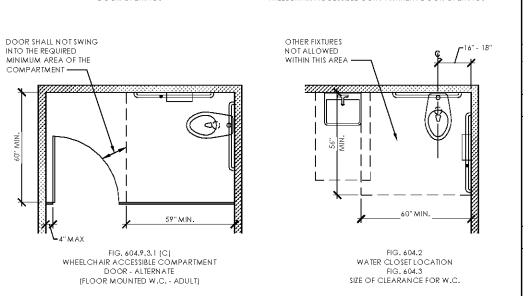

FIGURE 703.4.3 CHARACTER HEIGHT

FIGURE 703.4.3 BRAILLE MEASUREMENT

HEIGHT OF RAISED CHARACTERS

SCALE NOT TO SCALE 3



WATER CLOSET & TOILET COMPARTMENT

SCALE NOT TO SCALE 1

LAVATORY KNEE & TOE CLEARANCES

SCALE NOT TO SCALE 16

INTERNATIONAL ACCESSIBILITY SYMBOL

SCALE NOT TO SCALE 9



VERIZON WIRELESS
NEXT GEN
149 FITNESS WAY
JOHNSON CITY, TN
37604

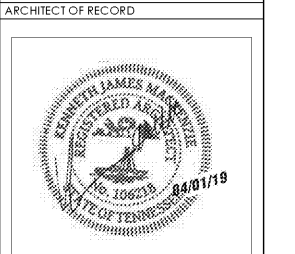
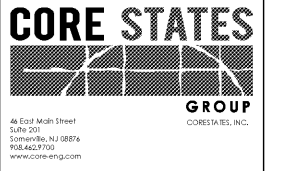

ISSUE	DATE	DESCRIPTION
-	04/01/19	PERMIT/ BID SET

PROJECT INFORMATION	
PROJECT NO:	V2W.26122
DATE:	04/01/2019
SCALE:	AS NOTED
DRAWN BY:	A. KLINKE
CHECKED BY:	V. VALVAEZ
SHEET TITLE	
ACCESSIBILITY DETAILS	
SHEET NUMBER	
G-001	