

RESINOUS FLOORING TRANSITIONS
 MASTER SPECIFICATION DETAIL
 DATE: 11/25/13
 SCALE: NONE
 DRAWN: ZAV
 ASD-4A

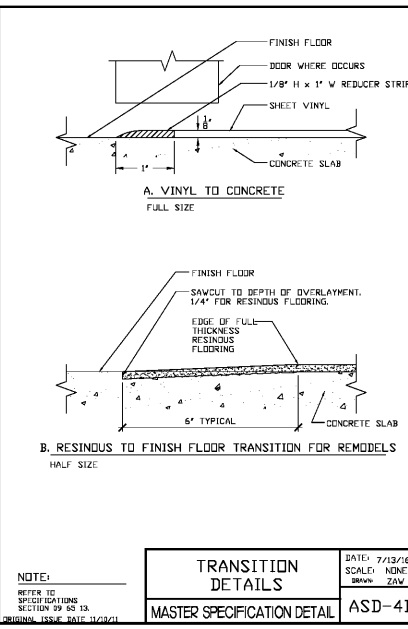

TRANSITION DETAILS
 MASTER SPECIFICATION DETAIL
 DATE: 7/13/16
 SCALE: NONE
 DRAWN: ZAV
 ASD-4B

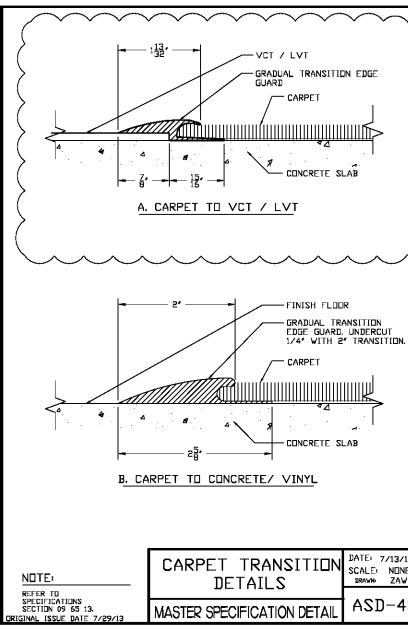

CARPET TRANSITION DETAILS
 MASTER SPECIFICATION DETAIL
 DATE: 7/13/16
 SCALE: NONE
 DRAWN: ZAV
 ASD-4E

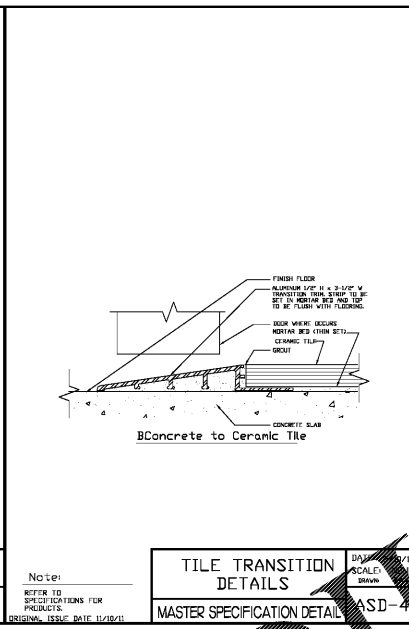

TILE TRANSITION DETAILS
 MASTER SPECIFICATION DETAIL
 DATE: 7/13/16
 SCALE: NONE
 DRAWN: ZAV
 ASD-4F

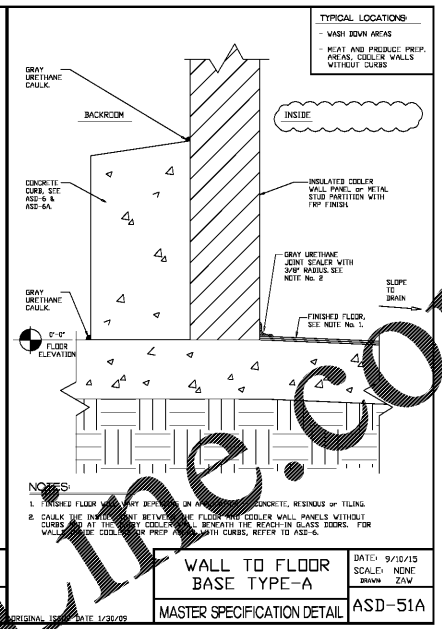

WALL TO FLOOR BASE TYPE-A
 MASTER SPECIFICATION DETAIL
 DATE: 9/10/15
 SCALE: NONE
 DRAWN: ZAV
 ASD-51A

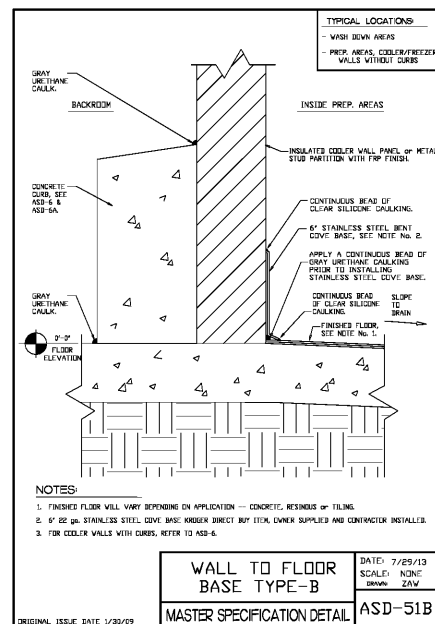

WALL TO FLOOR BASE TYPE-B
 MASTER SPECIFICATION DETAIL
 DATE: 7/25/13
 SCALE: NONE
 DRAWN: ZAV
 ASD-51B

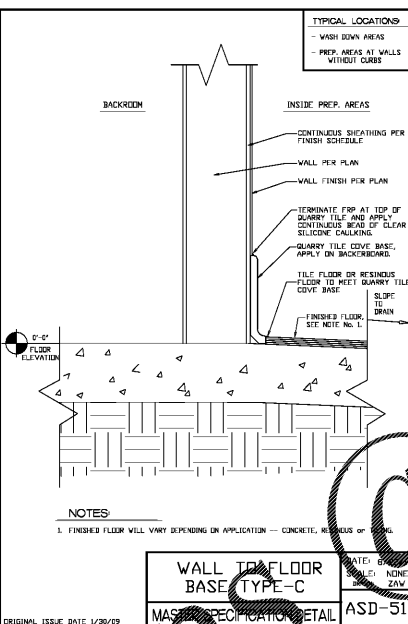

WALL TO FLOOR BASE TYPE-C
 MASTER SPECIFICATION DETAIL
 DATE: 8/1/13
 SCALE: NONE
 DRAWN: ZAV
 ASD-51C

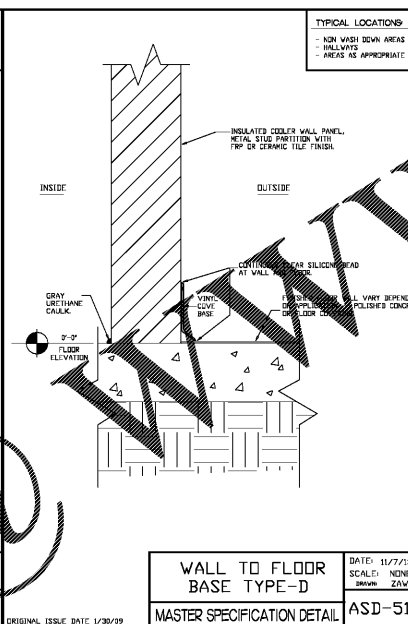

WALL TO FLOOR BASE TYPE-D
 MASTER SPECIFICATION DETAIL
 DATE: 11/7/13
 SCALE: NONE
 DRAWN: ZAV
 ASD-51D

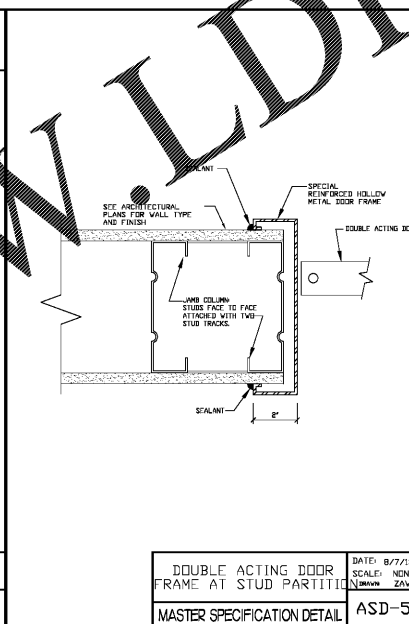

DOUBLE ACTING DOOR FRAME AT STUD PARTITION
 MASTER SPECIFICATION DETAIL
 DATE: 8/7/13
 SCALE: NONE
 DRAWN: ZAV
 ASD-56

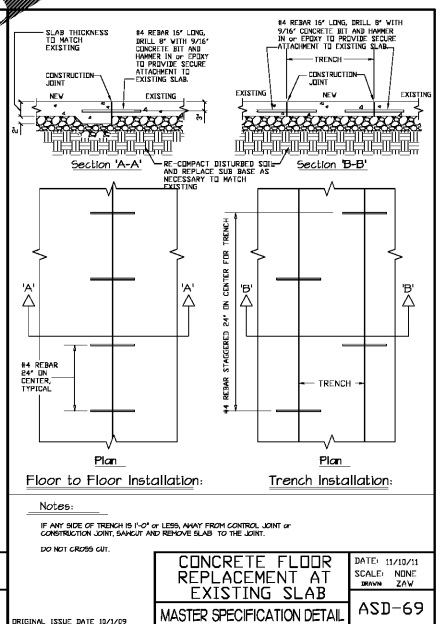

CONCRETE FLOOR REPLACEMENT AT EXISTING SLAB
 MASTER SPECIFICATION DETAIL
 DATE: 11/10/11
 SCALE: NONE
 DRAWN: ZAV
 ASD-69

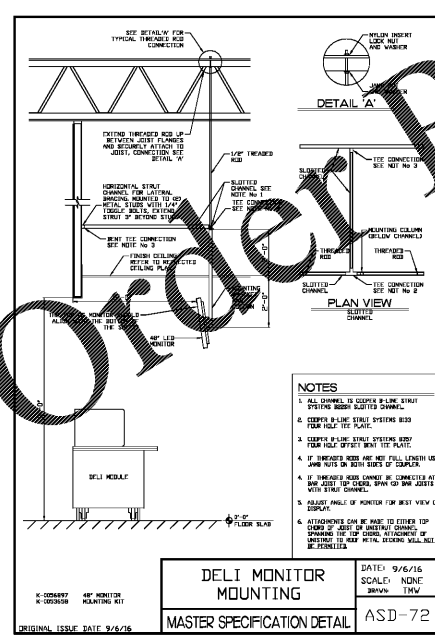

DELI MONITOR MOUNTING
 MASTER SPECIFICATION DETAIL
 DATE: 9/16/16
 SCALE: NONE
 DRAWN: TRV
 ASD-72

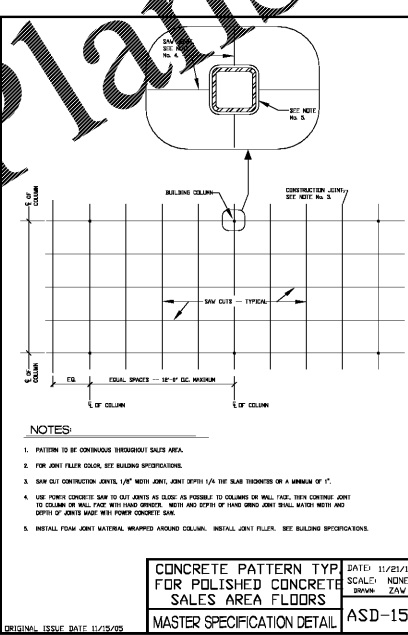

CONCRETE PATTERN TYP FOR POLISHED CONCRETE SALES AREA FLOORS
 MASTER SPECIFICATION DETAIL
 DATE: 11/23/14
 SCALE: NONE
 DRAWN: ZAV
 ASD-156

WWW.LDILLINE.COM

THIS DOCUMENT IS NOT FOR REGULATORY APPROVAL, PERMITTING, OR CONSTRUCTION.

A WITHIN THE WALLS REMODEL FOR:
KROGER STORE # 478 - MARIETTA - GA
 3162 JOHNSON FERRY RD.,
 MARIETTA, GA 30062



GENERAL OFFICE
 FACILITY ENGINEERING

FOR THE PROJECT: 2019 0125
 PROJECT NO: 2019 0125
 DATE: 03/18/2019

A5.1
 ARCHITECTURAL STANDARD
 DETAILS

CHECKED: CH DRAWN: MS