

BOLLARD DETAIL
NOT TO SCALE

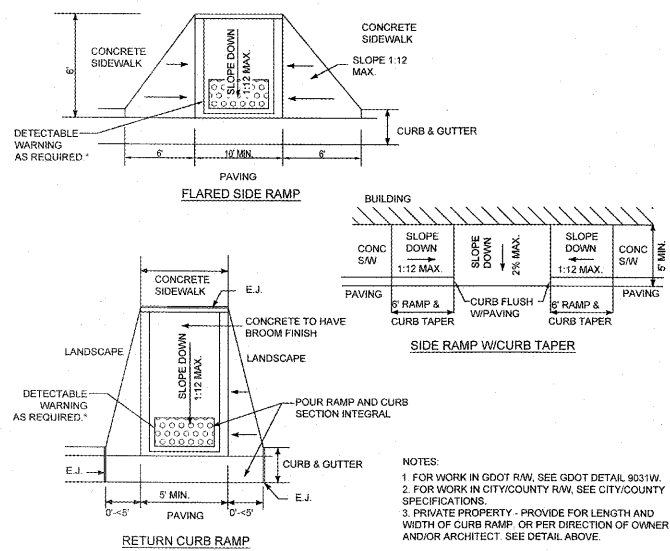

ADA PARKING RAMP DETAIL
NOT TO SCALE

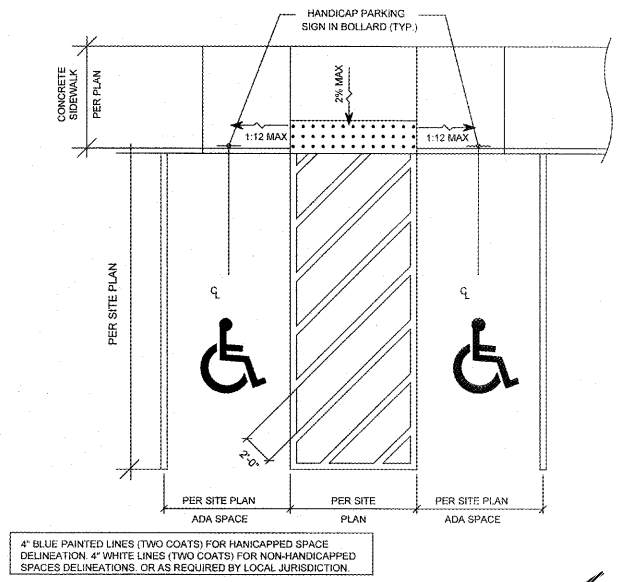

ADA PARKING LAYOUT DETAIL
NOT TO SCALE



ADA PARKING SIGN DETAIL
NOT TO SCALE

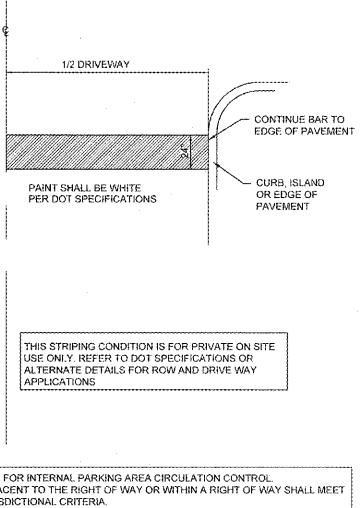

STOP BAR DETAIL
NOT TO SCALE

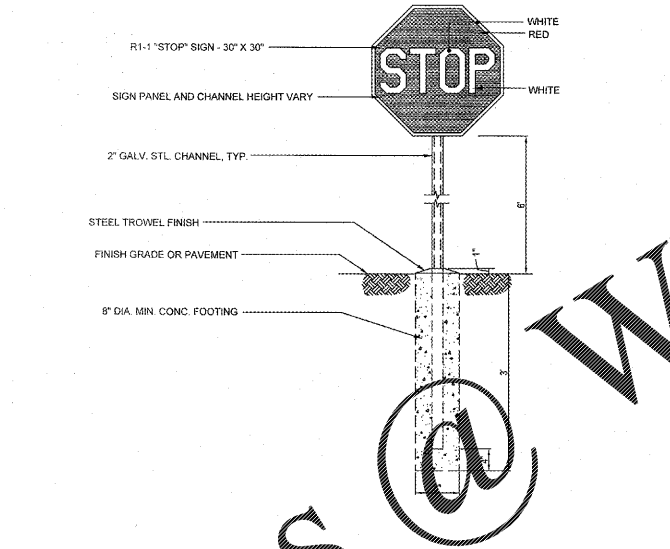

TRAFFIC SIGN MOUNTING DETAIL
NOT TO SCALE

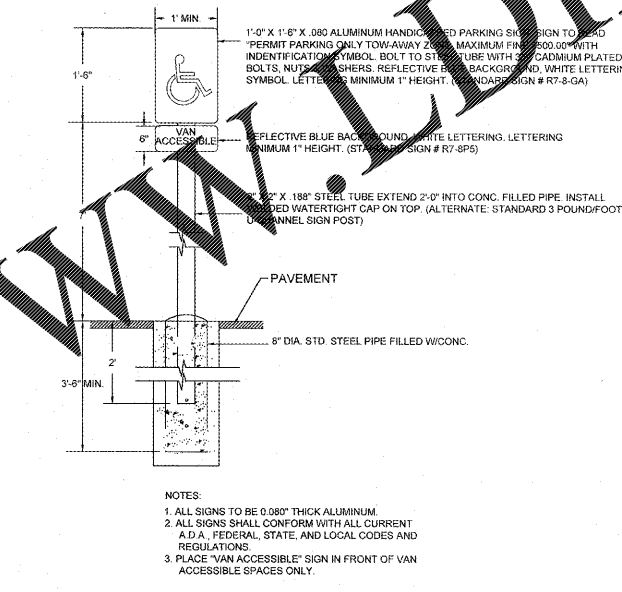

ADA SIGN MOUNTING DETAIL
NOT TO SCALE

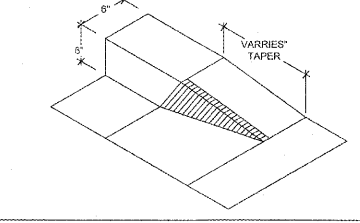

TAPER CURB DETAIL
NOT TO SCALE

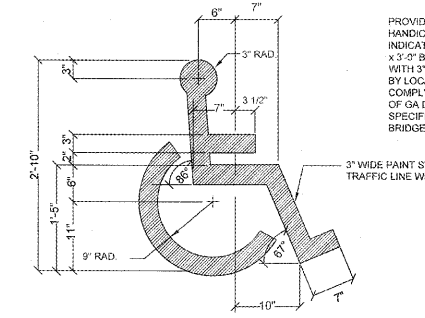

ADA PARKING SYMBOL DETAIL
NOT TO SCALE

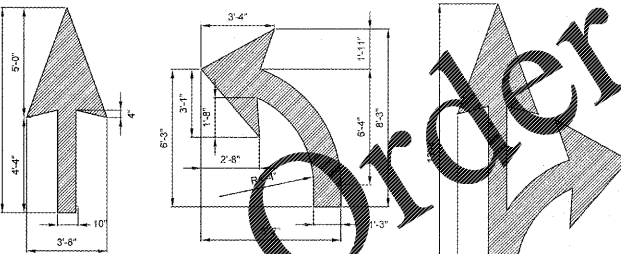

PAVEMENT MARKING DETAIL
NOT TO SCALE

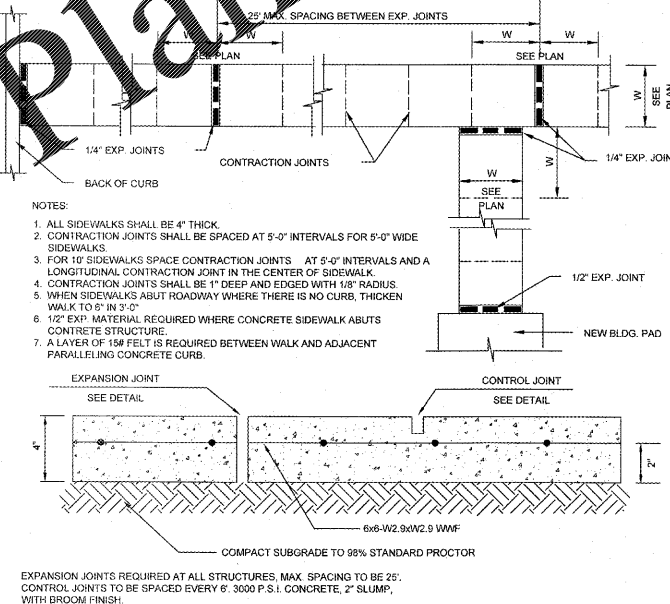

SIDEWALK DETAIL
NOT TO SCALE

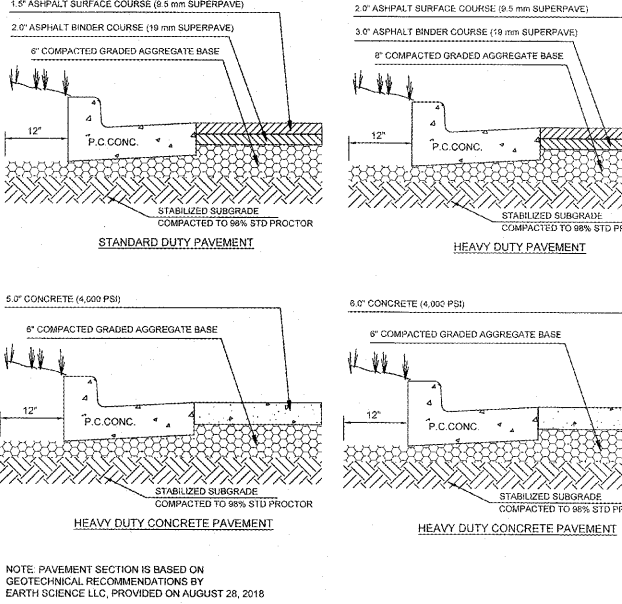

PAVEMENT SECTION DETAIL
NOT TO SCALE

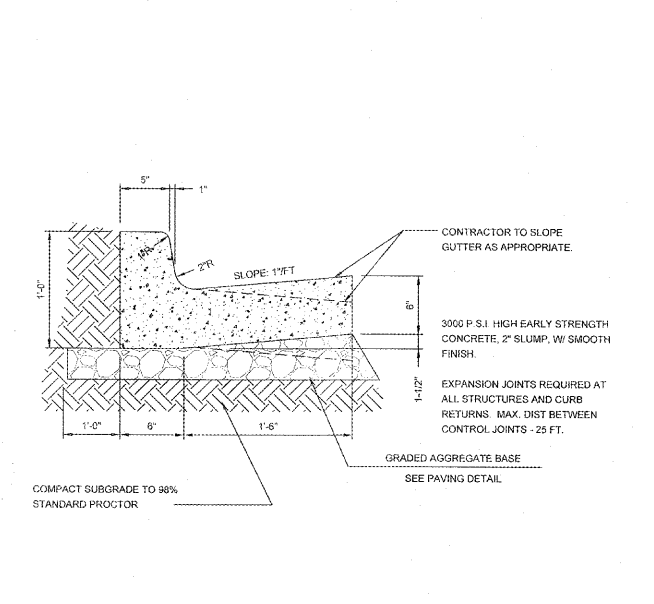

CURB & GUTTER DETAIL
NOT TO SCALE

LECRAW ENGINEERING
© 2018 LECRAW ENGINEERING, INC.
3475 CORPORATE WAY
DULUTH, GA 30096
PHONE - 770.548.8100
FAX - 770.441.0288
WWW.LECRAWENGINEERING.COM
PER000768

NO.	REVISIONS, COMMENTS, AND DATE	BY	CHECKED
1	NORCROSS, GWINNETT, AND DISTRICT COMMENT REVISIONS	TDD	MSL
	DATE	BY	CHECKED
	DATE	BY	CHECKED

CLIENT
CHRISTIAN BROTHERS AUTOMOTIVE
17725 KATY FREEWAY - SUITE 200 - HOUSTON, TX 77094

PROJECT
CHRISTIAN BROTHERS AUTOMOTIVE - NORCROSS
5650 PEACHTREE INDUSTRIAL BLVD
LAND LOT 272, DISTRICT 6, PARCEL 6272, 327
NORCROSS, GWINNETT COUNTY, GA

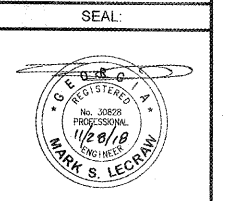

DESIGN TEAM:
DRAWN BY: TDD
DESIGNED BY: TDD
REVIEWED BY: MSL



DETAILS ARE NOT DRAWN TO SCALE

JOB #: 190005
DATE: 08/16/2018
CONSTRUCTION DETAILS - 1

C-7.0

Drawings name: L:\190005 - Christian Brothers Automotive - Norcross, GA\ADD\CONSTR\190005 - 10 - DETAILS.dwg CONSTRUCTION DETAILS - 1 Rev: 28, 2018 2:42pm by: thomas.dugan

Order Plans

WWW.Online.com