

SITE DEVELOPMENT:

1. SURFACE SLOPES OF PARKING SPACES FOR THE PHYSICALLY DISABLED SHALL NOT EXCEED 1/4-INCH PER FOOT IN ANY DIRECTION.
2. PEDESTRIAN WAYS THAT ARE ACCESSIBLE TO THE PHYSICALLY DISABLED SHALL BE PROVIDED FROM EACH DISABLED PARKING SPACE TO RELATED FACILITIES, INCLUDING CURBS CUTS OR RAMPS AS REQUIRED.
3. THE SURFACE OF EACH PARKING SPACE SHALL HAVE A SURFACE IDENTIFICATION DUPLICATING THE SYMBOL OF ACCESSIBILITY CONSISTING OF A WHITE FIGURE ON A BLUE BACKGROUND, AT LEAST 3 FEET SQUARE

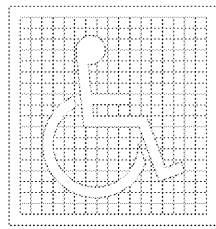

PROPORTIONS INTERNATIONAL SYMBOL OF ACCESSIBILITY



DISPLAY CONDITIONS INTERNATIONAL SYMBOL OF ACCESSIBILITY

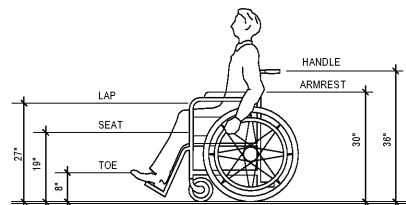

DIMENSIONS OF ADULT-SIZED WHEELCHAIRS

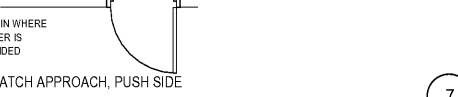
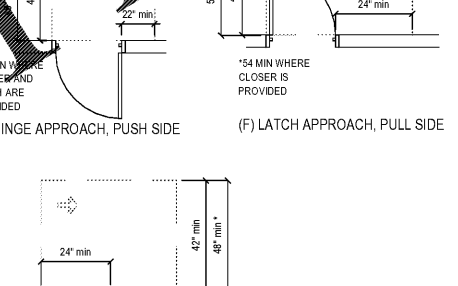
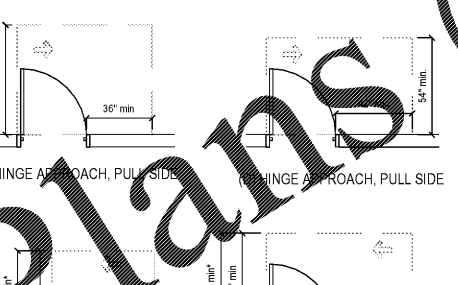
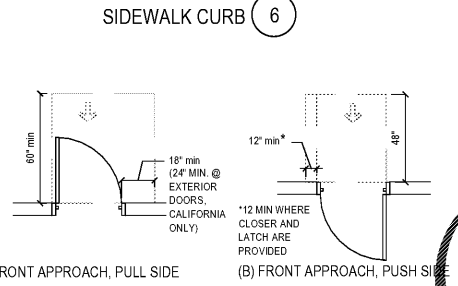
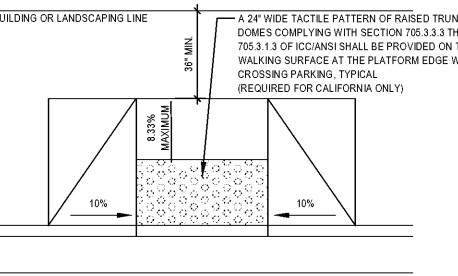
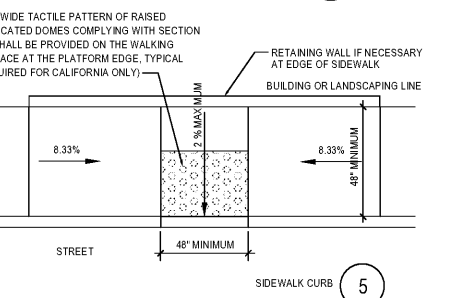
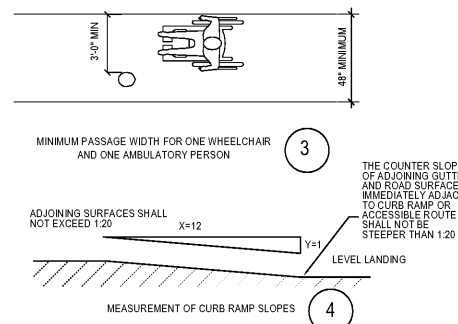

CURB RAMPS, WALKS AND SIDEWALKS:

4. WALKS AND SIDEWALKS SHALL HAVE CONTINUOUS COMMON SURFACE, NOT INTERRUPTED BY STEPS OR BY ABRUPT CHANGES IN LEVEL EXCEEDING 1/4" AND SHALL BE A MINIMUM OF 36" IN WIDTH PER ADA. (48" MIN. IS RECOMMENDED, 48" MIN. IS REQUIRED FOR CALIFORNIA)
5. WHEN THE SLOPE IN THE DIRECTION OF TRAVEL OF ANY WALK EXCEEDS 1 VERTICAL TO 20 HORIZONTAL (5% GRADIENT), IT SHALL COMPLY WITH THE PROVISIONS FOR PEDESTRIAN RAMPS.
6. SURFACE CROSS SLOPES SHALL NOT EXCEED 1.5% PER FOOT.
7. ABRUPT CHANGES IN LEVEL ALONG ANY ACCESSIBLE ROUTE SHALL NOT EXCEED 1/4" WHEN CHANGES IN LEVELS DO OCCUR. THEY SHALL NOT BE BEVELED WITH A SLOPE NOT GREATER THAN 1:2 EXCEPT THAT LEVEL CHANGES NOT EXCEEDING 1/4" MAY BE VERTICAL.
8. WHEN CHANGES IN LEVELS GREATER THAN 1/4" ARE NECESSARY, THEY SHALL COMPLY WITH THE REQUIREMENTS FOR CURB RAMPS & PEDESTRIAN RAMPS.
9. NOT USED
10. CURB RAMPS SHALL BE CONSTRUCTED AT EACH CORNER OF STREET INTERSECTION AND WHERE A PEDESTRIAN WAY CROSSES A CURB.
11. CURB RAMPS SHALL BE A MINIMUM OF 4 FEET WIDE AND SHALL BE GENERALLY IN A SINGLE SLOPED PLANE, WITH A MINIMUM OF SURFACE WALKWAY AND CROSS SLOPE.
12. THE SLOPE OF CURB RAMPS SHALL NOT EXCEED 1 VERTICAL TO 7 HORIZONTAL. THE SLOPE OF THE FANNED OR FLARED SIDES OF CURB RAMPS SHALL NOT EXCEED 1 VERTICAL TO 7.5 HORIZONTAL.
13. A 1.5% MAXIMUM SLOPE LANDINGS 5 FEET DEEP SHALL BE PROVIDED AT THE UPPER END OF EACH CURB RAMP TO PERMIT FULL STOP AND CROSS BARS TO BE ON THE RAMP SURFACE.
14. NOT USED
15. THE SURFACE OF EACH CURB RAMP AND ITS FLARED SIDES SHALL BE SLIP-RESISTANT AND SHALL BE OF CONTRASTING FINISH FROM THAT OF THE ADJACENT SIDEWALK.
16. NOT USED

ENTRANCES:

17. PROVIDE AT METALLIC SIGN OVER EACH STOREFRONT DOOR STATING: "THIS DOOR MUST REMAIN UNLOCKED DURING BUSINESS HOURS". LETTERS SHALL NOT BE LESS THAN 1" HIGH ON A CONTRASTING BACKGROUND. THE SIGN SHALL BE INSTALLED BY THE GENERAL CONTRACTOR ON THE STOREFRONT ALUMINUM HEADER FRAME.
18. ALL NEW PRIMARY ENTRANCES TO THE BUILDINGS AND FACILITIES SHALL BE MADE ACCESSIBLE TO THE PHYSICALLY DISABLED.
19. ACCESSIBLE ENTRANCES SHALL BE IDENTIFIED WITH AT LEAST ONE STANDARD SIGN AND WITH ADDITIONAL DIRECTIONAL SIGNS, AS REQUIRED, VISIBLE FROM APPROACHING PEDESTRIAN WAYS. GENERAL CONTRACTOR OR SHALL PROVIDE STANDARD SIGNAGE. CALIFORNIA REQUIRES ISA (INTERNATIONAL SYMBOL OF ACCESSIBILITY) AT ALL ACCESSIBLE ENTRANCES.
20. EVERY REQUIRED ENTRANCE OR PASSAGE DOORWAY SHALL BE OF A SIZE AS TO PERMIT THE INSTALLATION OF A DOOR NOT LESS THAN 3 FEET IN WIDTH AND NOT LESS THAN 6 FEET 7-8 INCHES IN HEIGHT. DOORS SHALL BE CAPABLE OF OPENING AT LEAST 90 DEGREES AND SHALL BE SO MOUNTED THAT THE CLEAR WIDTH OF DOORWAY IS NOT LESS THAN 32-INCHES
21. WHERE PAIR OF DOORS IS UTILIZED AT LEAST ONE OF THE DOORS SHALL PROVIDE A CLEAR UNOBSTRUCTED OPENING WIDTH OF 32-INCHES WITH THE LEAF POSITIONED AT AN ANGLE OF 90 DEGREES FROM ITS CLOSED POSITION.
22. LATCHING AND LOCKING DEVICES THAT ARE HAND ACTIVATED AND WHICH ARE IN PATH OF TRAVEL SHALL BE OPERABLE WITH A SINGLE EFFORT BY LEVER TYPE HARDWARE, THAT DOES NOT REQUIRE TIGHT GRASPING, PINCHING OR TWISTING OF WRIST TO OPERATE, PANIC BARS, PUSH-PULL ACTIVATING BARS, OR OTHER HARDWARE DESIGNED TO PROVIDE PASSAGE WITHOUT REQUIRING THE ABILITY TO GRASP THE OPENING HARDWARE. REFER TO SECTION 404.2.7 OF BC.
23. HAND ACTIVATED DOOR OPENING HARDWARE SHALL BE CENTERED BETWEEN 34-INCHES MINIMUM AND 48" ABOVE THE FLOOR. (34-INCHES TO 44-INCHES FOR CALIFORNIA ONLY)
24. THE FLOOR AND LANDING ON EACH SIDE OF AN ENTRANCE OR PASSAGE DOOR SHALL BE LEVEL AND CLEAR. THE LEVEL AND CLEAR AREA SHALL HAVE A LENGTH OF 60-INCHES IN THE DIRECTION OF TRAVEL AND THE LENGTH OF 48-INCHES IN OPPOSITE DIRECTION OF TRAVEL. SEE DIAGRAM "MANEUVERING CLEARANCE"
25. THE WIDTH OF THE LEVEL AND CLEAR AREA ON THE SIDE TO WHICH THE DOOR SWINGS SHALL EXTEND 24-INCHES PAST THE STRIKE EDGE OF THE DOOR FOR EXTERIOR DOORS AND 18-INCHES PAST THE STRIKE EDGE FOR THE INTERIOR DOORS.
26. THE FLOOR OR LANDING SHALL BE NOT MORE THAN 1/4" LOWER THAN THE THRESHOLD OF THE DOORWAY. CHANGE IN LEVEL BETWEEN 1/4" AND 1/2" SHALL BE BEVELED WITH A SLOPE NO GREATER THAN 1:2
27. THE BOTTOM 10" OF ALL DOORS EXCEPT AUTOMATIC AND SLIDING DOORS SHALL HAVE A SMOOTH UNINTERRUPTED SURFACE TO ALLOW THE DOOR TO BE OPENED BY A WHEELCHAIR FOOTREST WITHOUT CREATING A TRIP OR HAZARDOUS CONDITION. WHERE NARROW FRAME DOORS ARE USED, A 10" HIGH SMOOTH PANEL SHALL BE INSTALLED ON THE PUSHED SIDE OF THE DOOR, WHICH WILL ALLOW THE DOOR TO BE OPENED BY A WHEELCHAIR FOOTREST WITHOUT CREATING A TRIP OR HAZARDOUS CONDITION.
28. A NARROW FRAME WITH A BEVELED TOP (30 DEGREES MAX. BEVEL TO VERTICAL PLANE) INSTALLED AT THE BOTTOM OF THE GLASS DOOR (WITH NO SIDE FRAMES) MAY BE USED IN LIEU OF PROVIDING THE REQUIRED 10" UNINTERRUPTED SURFACE AT THE BOTTOM OF THE DOOR.
29. MAXIMUM EFFORT TO OPERATE DOORS SHALL NOT EXCEED 5 LBS. FOR EXTERIOR DOORS AND 5 LBS. FOR INTERIOR DOORS. SUCH PULL OR PUSH EFFORT BEING APPLIED AT RIGHT ANGLES TO HINGED DOORS AND AT THE CENTER PLANE OF SLIDING OR FOLDING DOORS. COMPENSATING DEVICES OR AUTOMATIC DOOR OPERATORS MAY BE UTILIZED TO MEET ABOVE STANDARDS. WHEN FIRE DOORS ARE REQUIRED, THE MAXIMUM EFFORT TO OPERATE THE DOOR MAY BE INCREASED NOT EXCEED 15 LBS.

CORRIDORS AND AISLE:

30. FLOOR SURFACES SHALL BE SLIP-RESISTANT
31. EVERY PORTION OF EVERY BUILDING IN WHICH ARE INSTALLED SEATING TABLES, MERCHANDISE, EQUIPMENT OR SIMILAR MATERIALS SHALL BE PROVIDED WITH ALLEYS LEADING TO AN EXIT.
32. EVERY AISLE SHALL BE NOT LESS THAN 3 FEET WIDE SERVING ONLY ONE SIDE. NOT LESS THAN 3 FEET 4 INCHES WIDE IF SERVING BOTH SIDES. SUCH MINIMUM WIDTH SHALL BE MEASURED AT THE NEAREST FRONT CORNER CROSS AISLE OR FOYER AND SHALL BE INCREASED BY 1-1/2" FOR EACH 5 FEET OF TRAVEL TOWARD THE EXIT. CROSS AISLE OR FOYER WITH CONTINUOUS TURNING SIDE AISLE SHALL BE NOT LESS THAN 44 INCHES IN WIDTH.

SANITARY FACILITIES:

33. EVERY SANITARY DESIGN CONTAINING TACTILE CHARACTER IS PROVIDED AT DOOR, THE SIGN SHALL BE CONSPICUOUS TO THE DOOR ON LATCH SIDE AND AT DOUBLE DOORS, THE SIGN SHALL BE RIGHT OF THE RIGHT HANDED DOOR. THE SIGN CONTAINING TACTILE CHARACTERS SHALL HAVE 18" MINIMUM BY 24" MINIMUM SPACE ON THE FLOOR CENTERED ON SIGN. THE SIGN TACTILE CHARACTER SHALL BE 48" MINIMUM TO THE BASELINE OF THE LOWEST TACTILE CHARACTER AND 15" MINIMUM TO THE BASELINE OF THE HIGHEST TACTILE CHARACTER ABOVE FLOOR.
34. CLEARANCE AROUND THE WATER CLOSET SHALL BE 60" MINIMUM MEASURED PERPENDICULAR FROM THE SIDEWALL, AND 56" MINIMUM MEASURED PERPENDICULAR FROM REAR WALL TO OTHER FIXTURES OR OBSTRUCTION SHALL BE WITHIN WATER CLOSET CLEARANCE (PER ADA) (REFER TO LOCAL JURISDICTION FOR ADDITIONAL REQUIREMENTS).
35. WATER CLOSET COMPARTMENTS SHALL BE EQUIPPED WITH A DOOR THAT HAS AN AUTOMATIC CLOSING DEVICE, AND SHALL HAVE A CLEAR UNOBSTRUCTED OPENING WIDTH OF 32-INCHES WHEN LOCATED AT THE END AND 34-INCHES WHEN LOCATED AT THE SIDE WITH THE DOOR POSITIONED AT AN ANGLE OF 90 DEGREES FROM ITS CLOSED POSITION.
36. EXCEPT FOR DOOR OPENING WIDTH AND DOOR SWINGS, A CLEAR UNOBSTRUCTED ACCESS NOT LESS THAN 44 INCHES SHALL BE PROVIDED TO WATER CLOSET COMPARTMENTS DESIGNED FOR USE BY THE DISABLED. THE SPACE IMMEDIATELY IN FRONT OF A WATER CLOSET COMPARTMENT SHALL BE NOT LESS THAN 48-INCHES AS MEASURED AT RIGHT ANGLES TO THE COMPARTMENT DOOR IN ITS CLOSED POSITION.
37. THE HEIGHT OF ACCESSIBLE WATER CLOSETS SHALL BE A MINIMUM OF 17-INCHES AND A MAXIMUM OF 19-INCHES MEASURED TO THE TOP OF TOILET SEAT.
38. TOILET FLUSH CONTROLS SHALL BE OPERABLE WITH ONE HAND, AND SHALL NOT REQUIRE TIGHT GRASPING, PINCHING, OR TWISTING OF THE WRIST. CONTROLS FOR THE FLUSH VALVES SHALL BE MOUNTED ON THE WIDE SIDE OF THE TOILET AREAS, NO MORE THAN 44-INCHES ABOVE THE FLOOR. THE FORCE REQUIRED TO ACTIVATE CONTROLS SHALL BE NO GREATER THAN 5 POUNDS.
39. WHERE URINALS ARE PROVIDED, AT LEAST ONE SHALL HAVE A CLEAR SPACE 30-INCHES WIDE X 48-INCHES LONG IN FRONT OF THE URINAL.
40. WHEN MORE THAN ONE URINAL IS PROVIDED, AT LEAST ONE SHALL BE THE STALL-TYPE OR THE WALL-HUNG TYPE WITH THE RIM 17" MAXIMUM ABOVE THE FINISH FLOOR. URINALS SHALL BE 13-1/2" DEEP MEASURED FROM THE OUTER FACE OF THE URINAL RIM TO THE BACK OF THE FIXTURE.
41. A CLEAR FLOOR FORWARD APPROACH, AND KNEE AND TOE CLEARANCE SHALL BE PROVIDED. A SPACE 30-INCHES MINIMUM WIDE X 48-INCHES MINIMUM LONG SHALL BE PROVIDED IN FRONT OF A LAVATORY TO ALLOW A FORWARD APPROACH. ONE FULL UNOBSTRUCTED SIDE OF THE CLEAR FLOOR SHALL ADJOIN AN ACCESSIBLE ROUTE OR ADJOIN ANOTHER CLEAR FLOOR SPACE. SUCH CLEAR FLOOR SPACE SHALL BE PERMITTED TO INCLUDE KNEE AND TOE CLEARANCE UNDERNEATH THE LAVATORY.
42. LAVATORIES SHALL BE INSTALLED WITH THE FRONT OF THE HIGHER OF THE RIM OR COUNTER SURFACE 34-INCHES MAXIMUM ABOVE THE FINISH FLOOR.
43. TOE CLEARANCE: SPACE UNDER AN ELEMENT BETWEEN THE FINISH FLOOR AND 9-INCHES ABOVE THE FINISH FLOOR SHALL BE CONSIDERED TOE CLEARANCE. TOE CLEARANCE SHALL EXTEND 17-INCHES MINIMUM TO 25-INCHES MAXIMUM UNDER AN ELEMENT WITH A WIDTH OF 30-INCHES MINIMUM. SPACE EXTENDING GREATER THAN 6-INCHES BEYOND THE AVAILABLE KNEE CLEARANCE AT 9-INCHES ABOVE THE FINISH FLOOR SHALL NOT BE CONSIDERED TOE CLEARANCE.

TELEPHONES:

58. IF PUBLIC TELEPHONES ARE PROVIDED, THEY SHALL COMPLY WITH DISABLED ACCESS REQUIREMENTS.
59. PROVIDE 30" X 48" CLEAR SPACE AT TELEPHONE. THE CLEAR SPACE MAY INCLUDE KNEE SPACE UNDER THE TELEPHONE.
60. THE HIGHEST OPERABLE PART OF THE TELEPHONE SHALL BE WITHIN 48-INCHES OF THE FLOOR IF FORWARD APPROACHED AND UNOBSTRUCTED SIDE REACH AND 48-INCHES MAX IF SIDE APPROACHED WITH 10" MAX OBSTRUCTED AND 46" MAX WITH 24" MAX OBSTRUCTION.
61. SIDE APPROACH TELEPHONES REQUIRE THAT THE ENCLOSURE OVERHANG BE NO MORE THAN 19-INCHES AND BE AT LEAST 27-INCHES FROM THE FLOOR.
62. THE CORD FROM THE TELEPHONE TO THE HANDSET SHALL BE AT LEAST 28-INCHES LONG.
63. TELEPHONES SHALL BE HEARING AID COMPATIBLE PER ICCANSI SEC. 704.2.6
64. TELEPHONES SHALL HAVE PUSH-BUTTON CONTROLS WHERE SERVICE FOR SUCCESSIVE CALLS IS AVAILABLE.

ADDITIONAL REQUIREMENTS:

65. THE CENTER OF RECEPTACLE OUTLETS SHALL BE NOT MORE THAN 15-INCHES ABOVE THE FLOOR OR WORKING PLATFORMS.
66. THE CENTER OF THE GRIP OF THE OPERATING HANDLE OF SWITCHES, INTENDED TO BE USED BY THE OCCUPANTS OF THE ROOM OR OFFICE, SHALL BE 48" MINIMUM TO 54" MAXIMUM ABOVE THE FLOOR. APPLIANCE COOLING HANDLES AND TILT-UP SWITCHES SHALL BE 48" MAX HEIGHT FOR UNOBSTRUCTED FORWARD AND SIDE REACH. 48" MIN. TO 54" MAX. HEIGHT WITH 10" MAX OBSTRUCTION AT SIDE REACH. 48" MAX HEIGHT AT 24" MAX OBSTRUCTION AT SIDE REACH.
67. THE INTERNATIONAL SYMBOL OF ACCESSIBILITY SHALL BE THE STANDARD USED TO IDENTIFY FACILITIES THAT ARE ACCESSIBLE TO PHYSICALLY DISABLED PERSONS. THE SYMBOL SPECIFIED SHALL BE A WHITE FIGURE ON A BLUE BACKGROUND. THE BLUE SHALL BE EQUAL TO OR MORE 15690 IN FEDERAL STANDARD 555A.

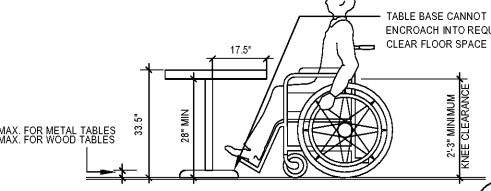
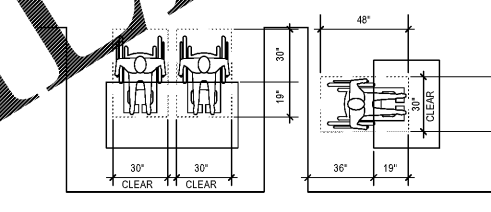
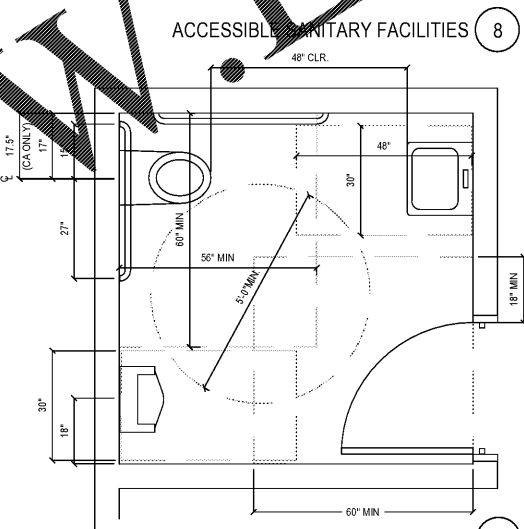
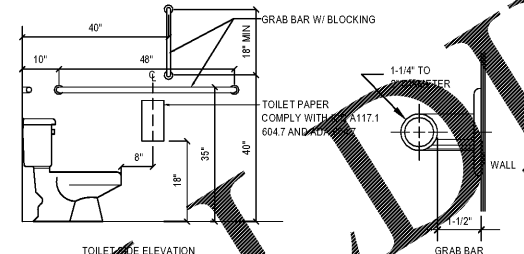

MINIMUM CLEARANCES FOR SEATING AND TABLES

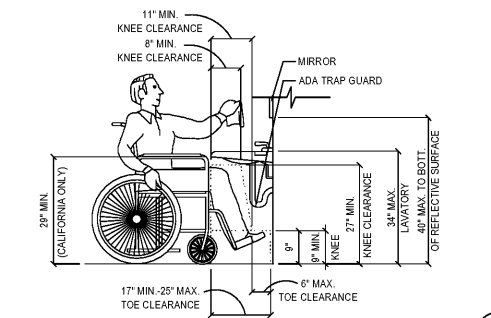
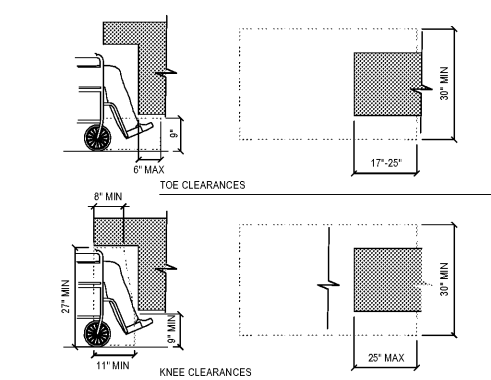

TOE & KNEE CLEARANCES

44. KNEE CLEARANCE: SPACE UNDER AN ELEMENT BETWEEN 9-INCHES AND 27-INCHES ABOVE THE FINISH FLOOR SHALL BE CONSIDERED KNEE CLEARANCE. KNEE CLEARANCE SHALL EXTEND 25-INCHES MAXIMUM UNDER AN ELEMENT AT 9-INCHES ABOVE THE FINISH FLOOR AND BE 30-INCHES WIDE MINIMUM. KNEE CLEARANCE SHALL BE 11-INCHES DEEP MINIMUM AT 8-INCHES ABOVE FINISH FLOOR, AND 8-INCHES DEEP MINIMUM AT 27-INCHES ABOVE FINISH FLOOR.
45. FAUCET CONTROLS AND OPERATING MECHANISMS SHALL BE OPERABLE WITH ONE HAND AND SHALL NOT REQUIRE TIGHT GRASPING, PINCHING OR TWISTING OF THE WRIST. THE FORCE REQUIRED TO ACTIVATE OPERABLE PARTS SHALL BE 5 POUNDS MAXIMUM. LEVER-OPERATED, PUSH-TYPE AND ELECTRONICALLY CONTROLLED MECHANISMS ARE EXAMPLES OF ACCEPTABLE DESIGN. HAND OPERATED METERING FAUCETS SHALL REMAIN OPEN FOR 10 SECONDS MINIMUM.
46. MIRRORS SHALL BE MOUNTED WITH THE BOTTOM REFLECTING EDGE NOT MORE THAN 40-INCHES FROM THE FLOOR.
47. LOCATE TOWEL, SANITARY NAPKIN, AND WASTE RECEPTACLES WITH ALL OPERABLE PARTS NOT MORE THAN 40-INCHES FROM THE FLOOR.
48. LOCATE TOILET TISSUE DISPENSERS ON THE WALL WITHIN 7-9 INCHES IN FRONT OF THE WATER CLOSET MEASURED TO THE CENTERLINE OF THE DISPENSER. THE OUTLET SHALL BE 15 INCHES MINIMUM AND 48 INCHES MAXIMUM ABOVE THE FLOOR, AND SHALL NOT BE LOCATED BEHIND THE GRAB BARS. DISPENSERS SHALL NOT BE OF A TYPE THAT CONTROLS DELIVERY, OR DO NOT ALLOW CONTINUOUS PAPER FLOW.



PANDA EXPRESS, INC.
1683 Walnut Grove Ave.
Rosemead, California
91770
Telephone: 626.799.9898
Facsimile: 626.372.8288

All ideas, designs, arrangement and plans indicated or represented by this drawing are the property of Panda Express Inc. and were created for use on this specific project. None of these ideas, designs, arrangements or plans may be used by or disclosed to any person, firm, or corporation without the written permission of Panda Express Inc.

REVISIONS:

NO.	DESCRIPTION	DATE

ISSUE DATE:

ISSUE FOR PERMIT 11-30-18

DRAWN BY: RR

PANDA PROJECT # S8-19-D6559

ARCH PROJECT # 1805



315 WALTER ROBERTS ST • FRANKLIN, TN 37064
PHONE (615) 496-4250 • FAX (666) 584-1225



PANDA EXPRESS
ELM HILL PIKE AT DONELSON PIKE
2740 ELM HILL PIKE
NASHVILLE, TN 37214

2200 TRUE R1 (DAB 103)

A-406

HANDICAPPED NOTES AND DETAILS