

1 FASCIA DETAIL
SCALE: 3" = 1'-0"

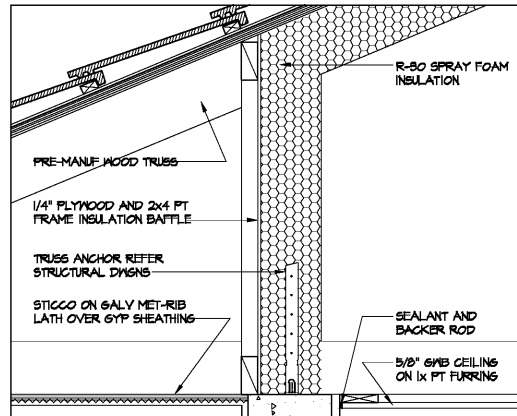

2 TRUSS INSULATION BATTLE
SCALE: 1 1/2" = 1'-0"

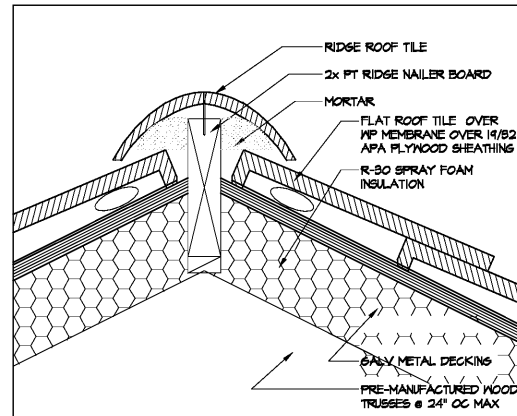

3 RIDGE VENT DETAIL
SCALE: 3" = 1'-0"

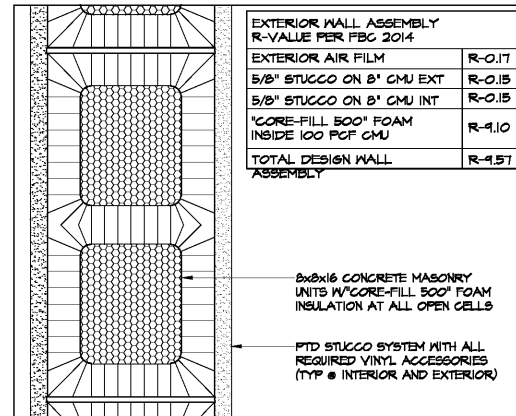

4 TYPICAL EXTERIOR WALL
SCALE: 3" = 1'-0"

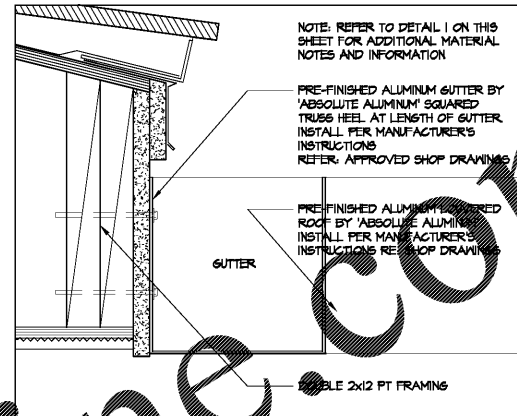

14 LOUVERED ROOF AT FASCIA
SCALE: 3" = 1'-0"

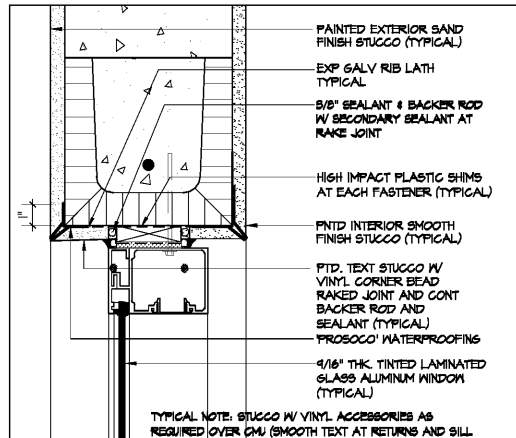

5 FIXED WINDOW HEAD
SCALE: 3" = 1'-0"

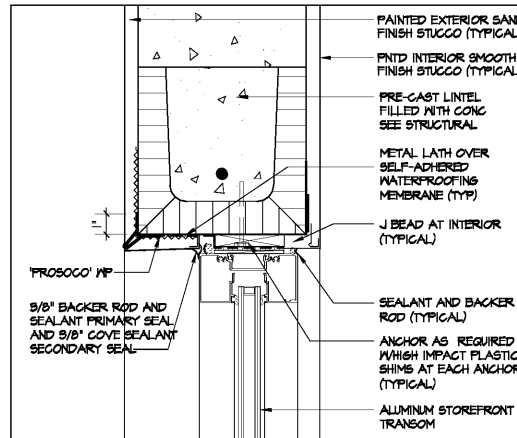

6 STOREFRONT HEAD
SCALE: 3" = 1'-0"

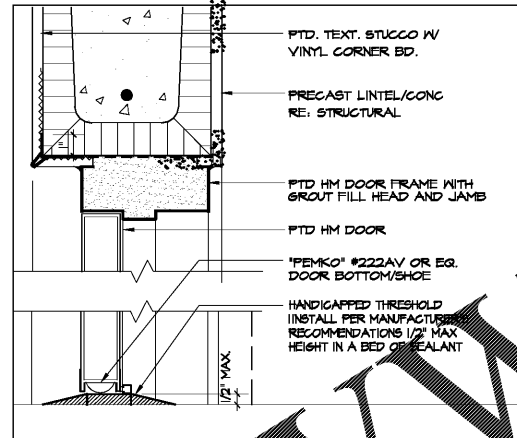

7 EXT. HM DOOR HEAD/SILL
SCALE: 3" = 1'-0"

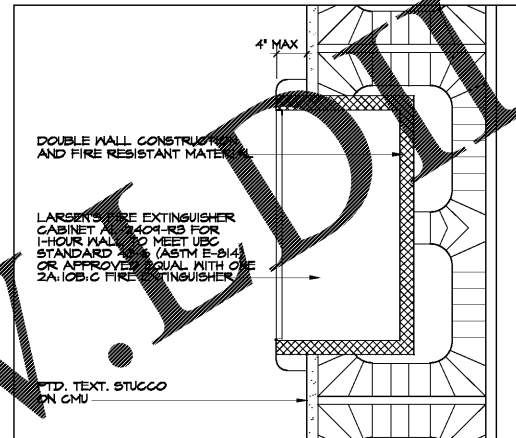

8 FIRE EXTINGUISHER CAB AT CMU
SCALE: 3" = 1'-0"

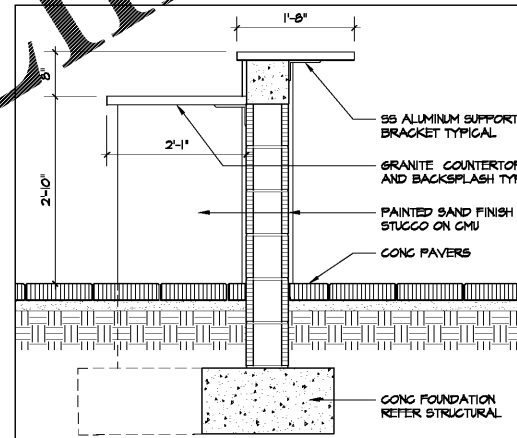

15 OUTDOOR BAR
SCALE: 3/4" = 1'-0"

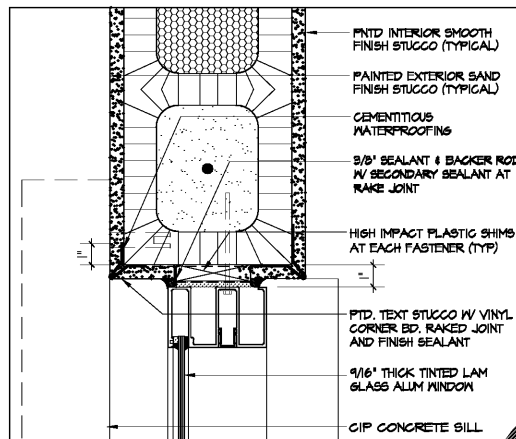

9 FIXED WINDOW JAMB
SCALE: 3" = 1'-0"

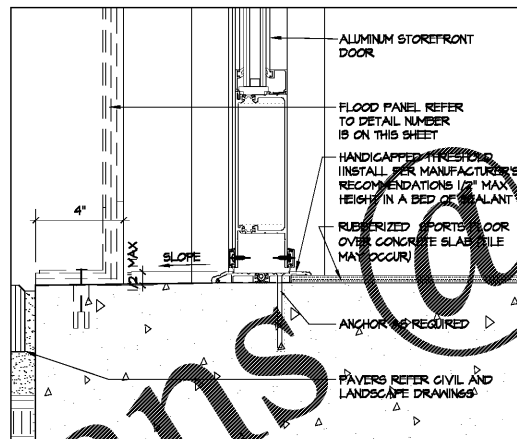

10 STOREFRONT THRESHOLD
SCALE: 3" = 1'-0"

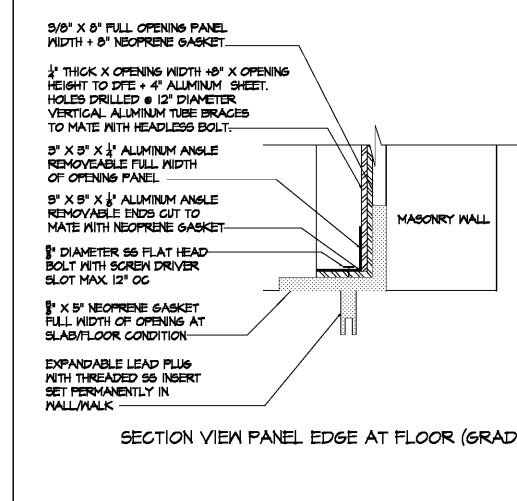
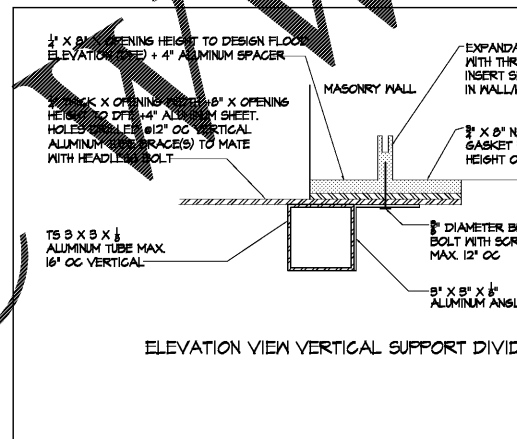

13 FLOOD PANELS DETAILS
SCALE: 3" = 1'-0"

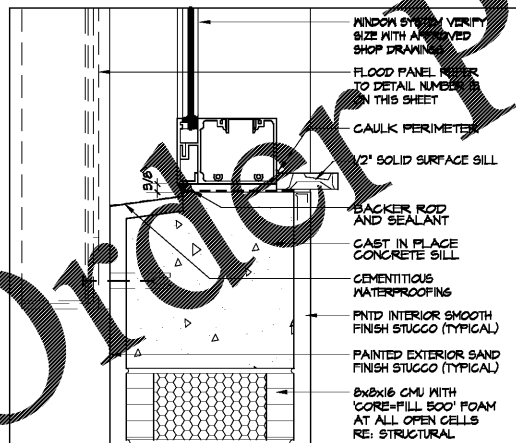
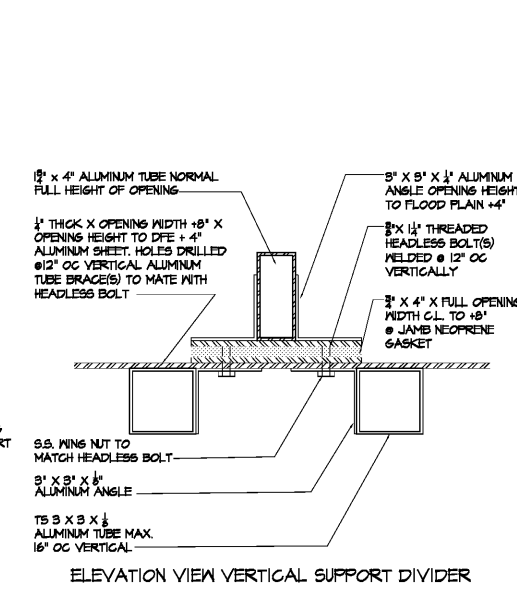
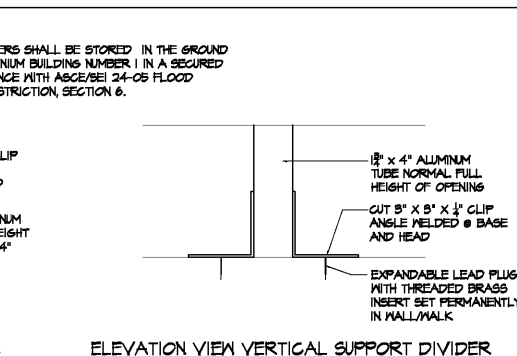
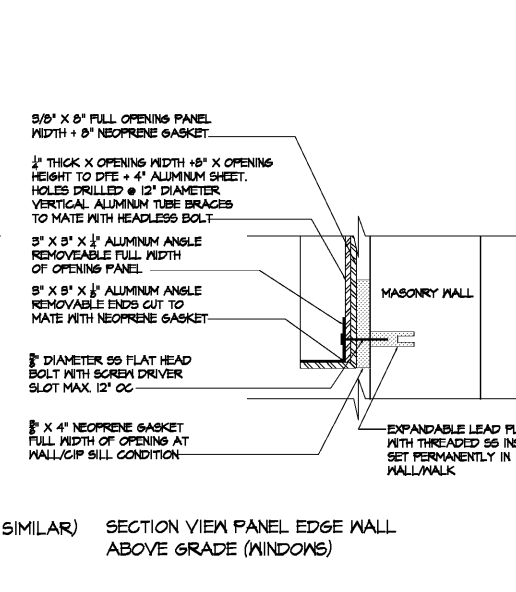
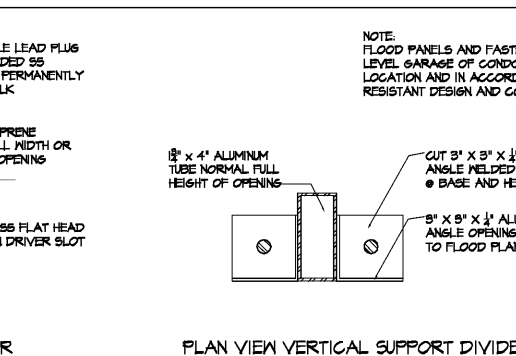

11 FIXED WINDOW SILL
SCALE: 3" = 1'-0"

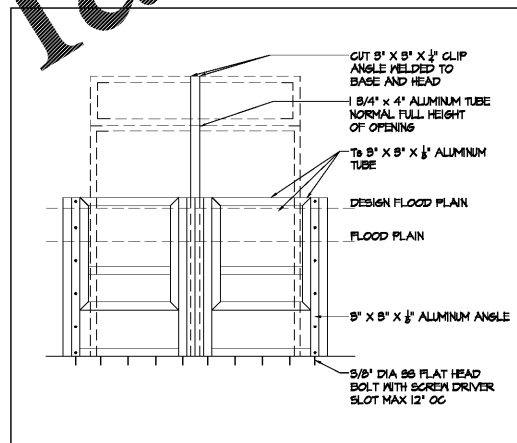

12 FLOOD PANELS ELEVATION
SCALE: 3/8" = 1'-0"

To the best of the Architect's knowledge, the plans, specifications and contract documents do not contain any fire-safety standards as required by the local jurisdiction. The user assumes all responsibility for compliance with applicable fire-safety codes.



CURTIS GAMES HALL JONES ARCHITECTS
1818 E. 9TH AVE
TAMPA FLORIDA 33606
PHONE 813 228-8000
FAX 813 228-0770
FL. CERT. #AA0001980

JOB NO. 1818
DATE JUL 18, 2018
DRAWN BY EV
REV. 1 JAN 24, 2018
REV. 2
REV. 3
REV. 4
REV. 5
REV. 6
REV. 7
REV. 8
REV. 9
REV. 10
REV. 11
REV. 12

ARCHITECT OF RECORD
Robert D. Hall
ARE 0014108

AMENITY II
DETAILS

A5.10