

1 BEVERAGE WATER PIPING SCHEMATIC

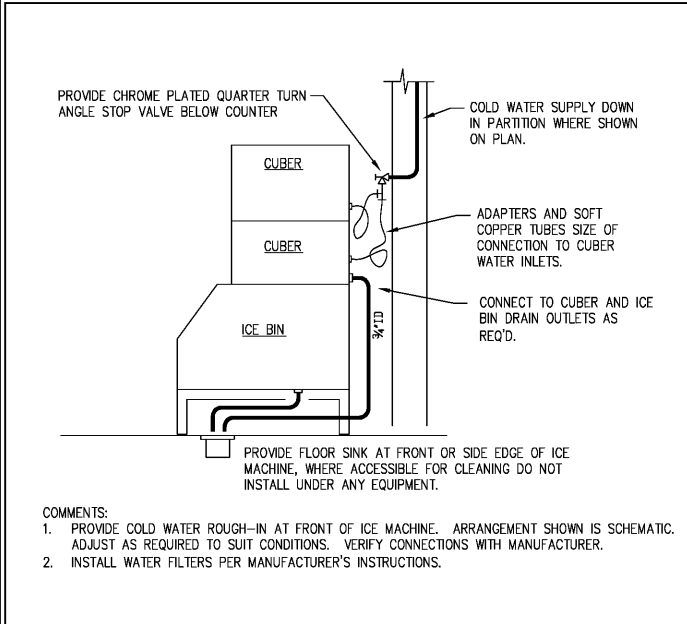

2 ICE MACHINE PIPING SCHEMATIC

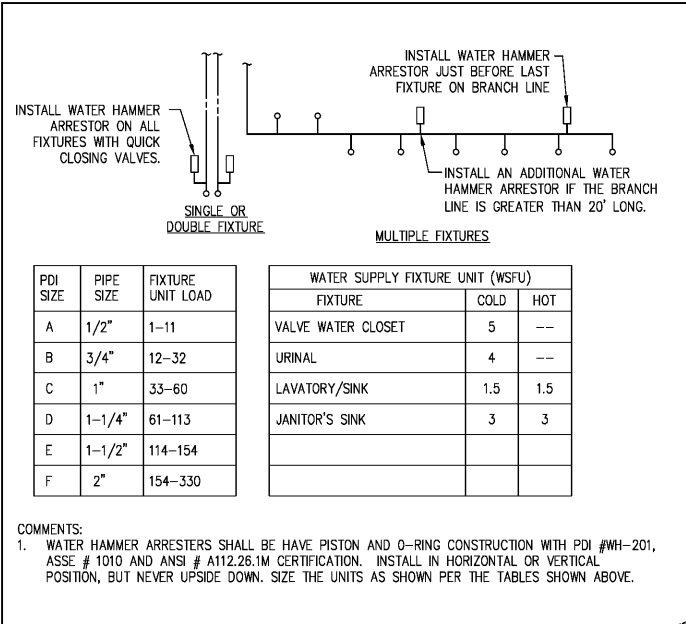

3 WATER HAMMER ARRESTER DETAIL

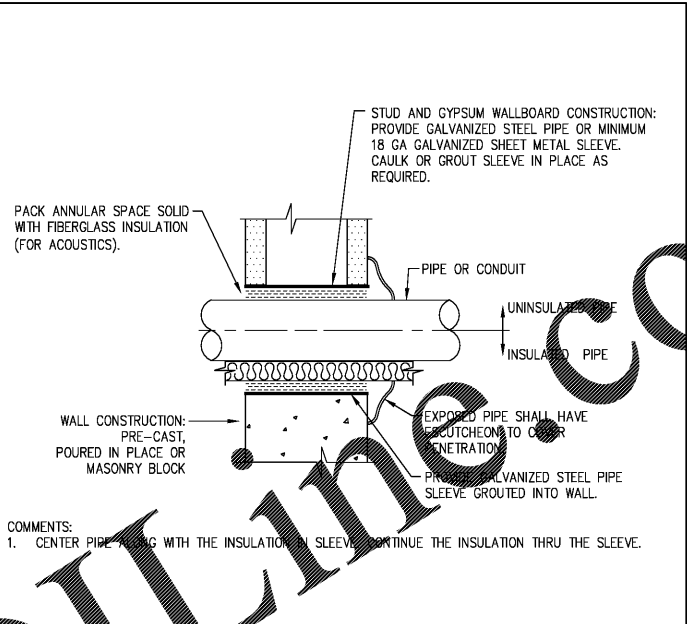

PIPE PENETRATION (NON-RATED WALL)

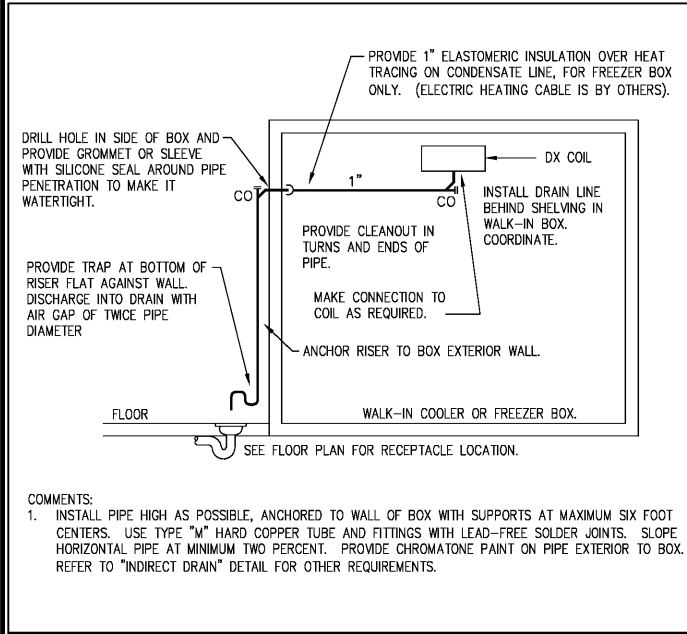

5 CONDENSATE DRAIN (WALK-IN BOX)

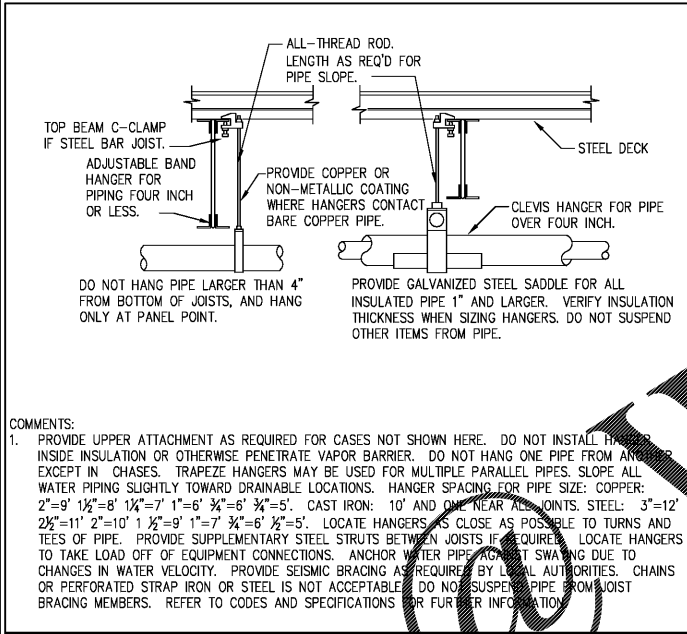

6 PIPE HANGER DETAIL

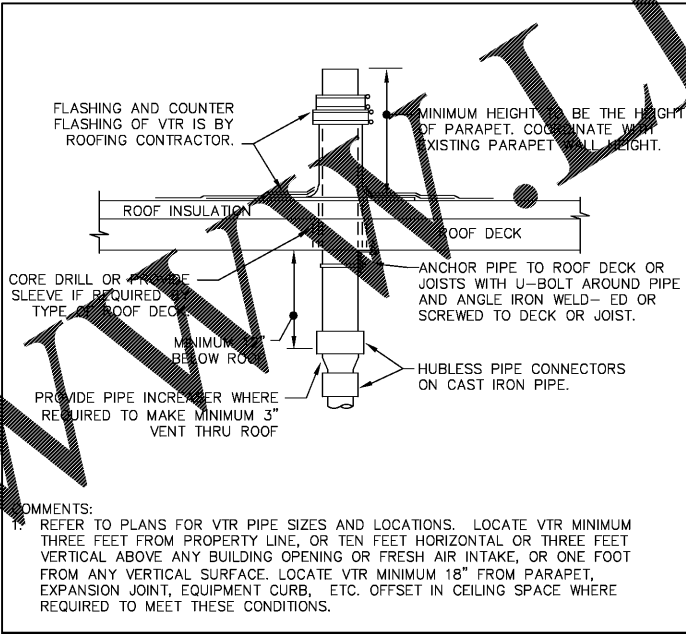

7 VENT THRU ROOF (VTR) DETAIL

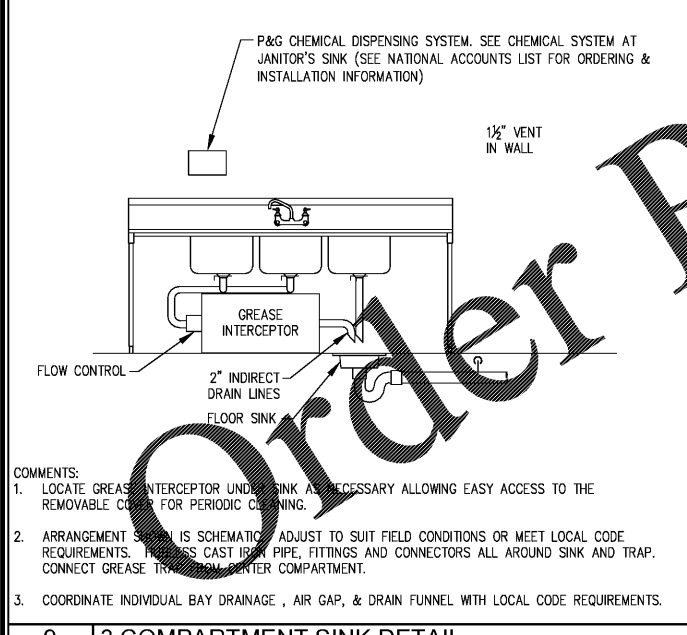

9 3 COMPARTMENT SINK DETAIL

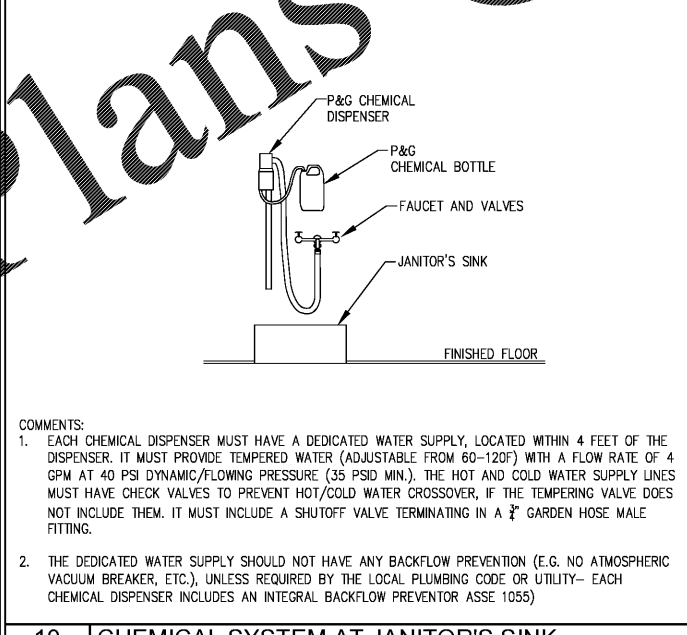

10 CHEMICAL SYSTEM AT JANITOR'S SINK

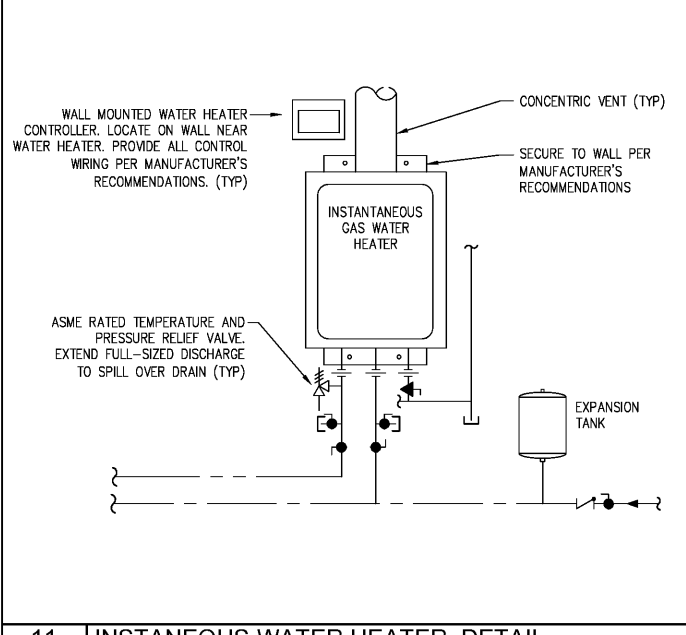

11 INSTANEOUS WATER HEATER DETAIL

THESE PLANS ARE CONFIDENTIAL PROPERTY OF DUNKIN' BRANDS, INC. UNLESS RESTRICTED ACCESS.

RM3 ENGINEERING
2302 Brackett Road
TUCKER, GEORGIA 30084
770 934 0944

DATE	SCALE	DRAWN	CHKD	APPD
2-25-19	1/4"=1'-0"	SR	RMS	

DUNKIN DONUTS SPRING STREET
1270 SPRING ST, SUITE 3, ATLANTA, GA 30309

PLUMBING DETAILS

3E18-130