

5 FOOD SERVICE SOFFIT SECTION  
A11.1 3/4" = 1'-0"

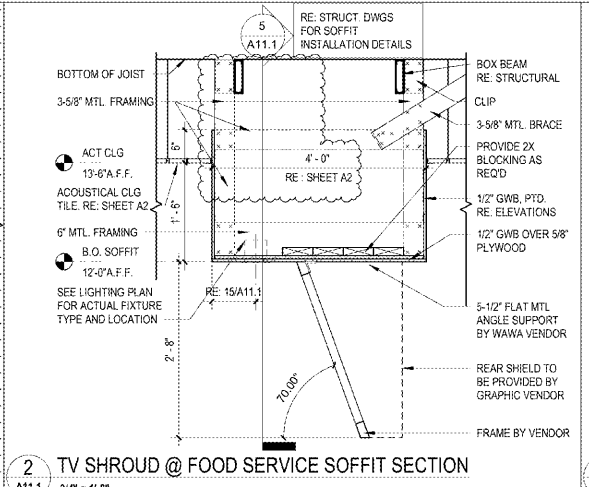

2 TV SHROUD @ FOOD SERVICE SOFFIT SECTION  
A11.1 3/4" = 1'-0"

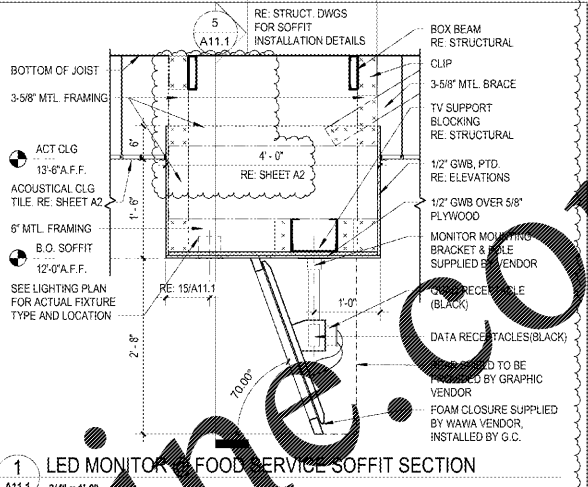

1 LED MONITOR @ FOOD SERVICE SOFFIT SECTION  
A11.1 3/4" = 1'-0"

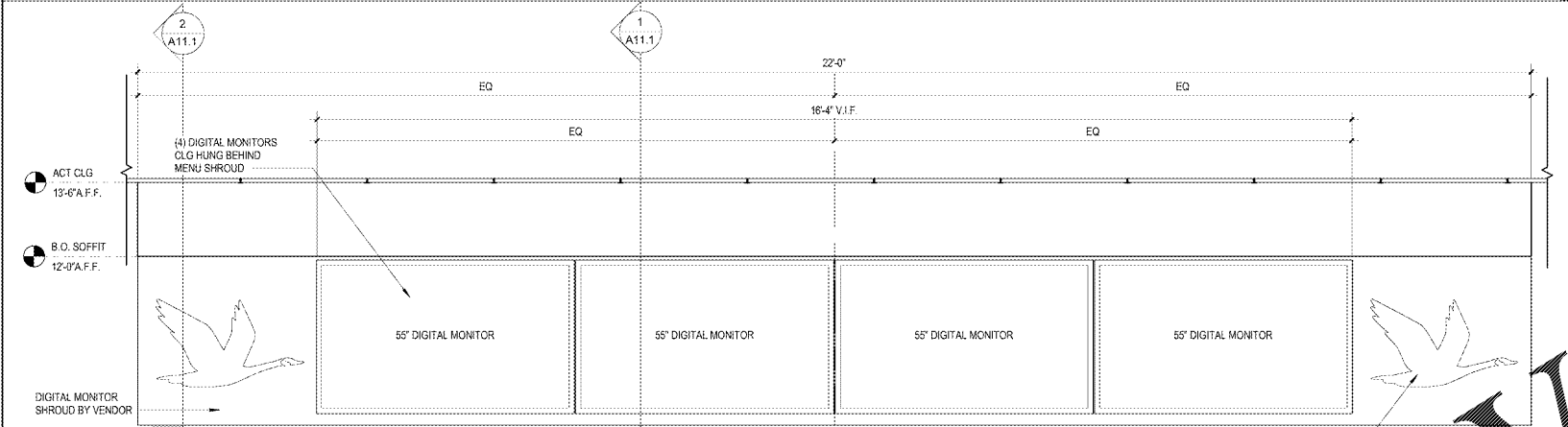

10 FOOD SERVICE SOFFIT ELEVATION  
A11.1 3/4" = 1'-0"

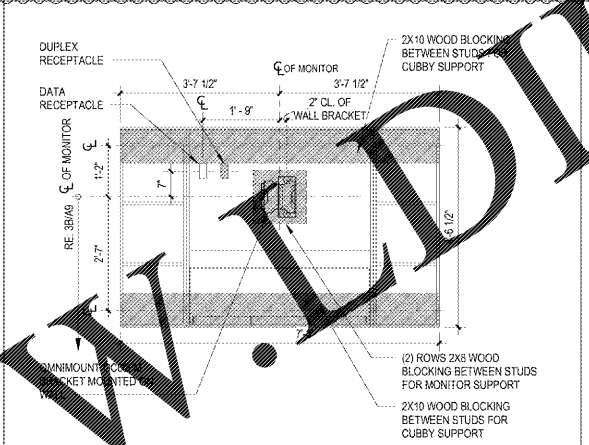

7 COFFEE CUBBY MOUNTING DETAIL  
A11.1 1/2" = 1'-0"

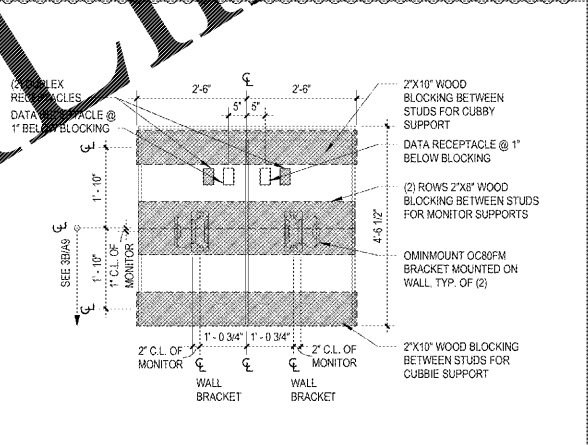

6 FULL SERVE CUBBY MOUNTING DETAIL  
A11.1 1/2" = 1'-0"

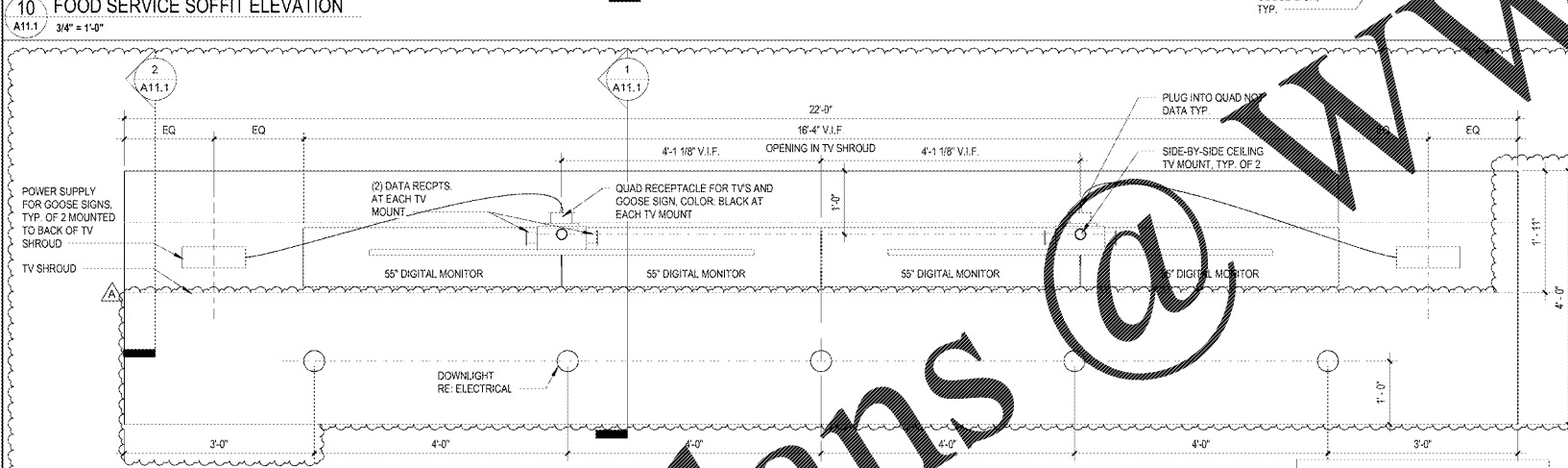

15 FOOD SERVICE SOFFIT RCP  
A11.1 3/4" = 1'-0"

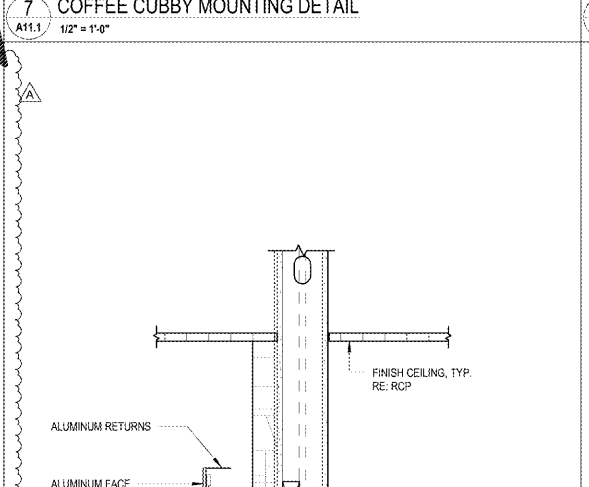

11 CHECKOUT CLOUD DETAIL  
A11.1 3/4" = 1'-0"

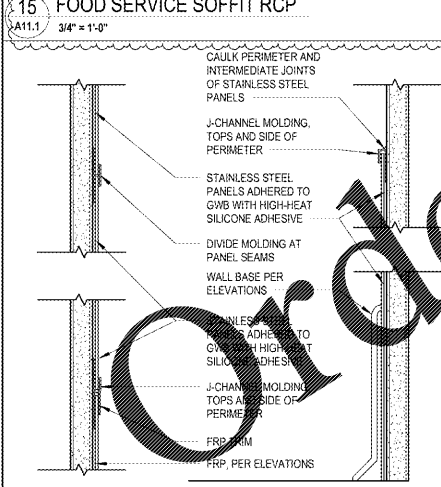

20 STAINLESS STEEL WALL PANEL DETAIL  
A11.1 6" = 1'-0"

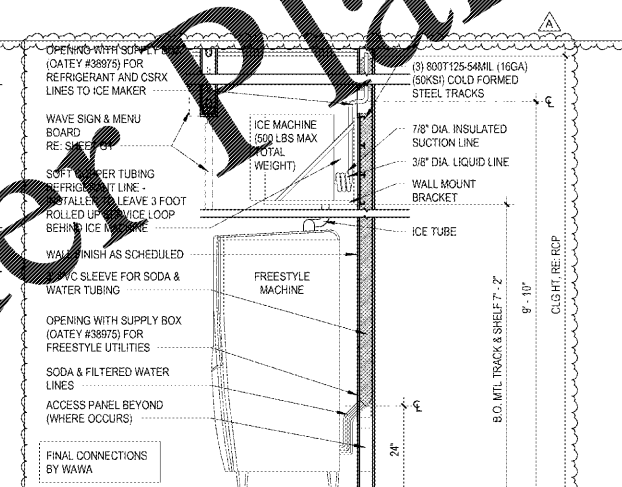

19 SECTION @ DRINK MACHINE  
A11.1 1/2" = 1'-0"

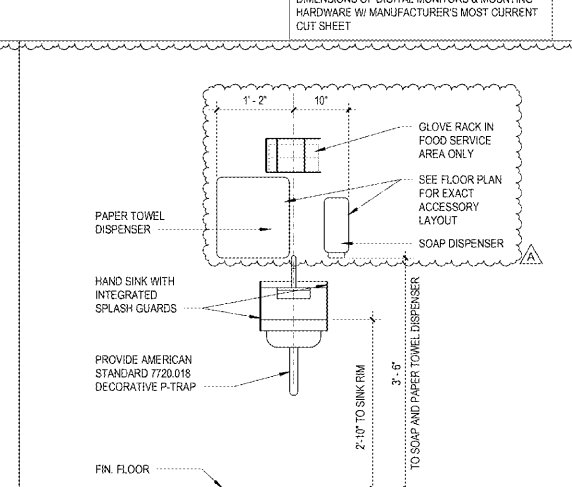

18 HANDWASH SINK DETAIL  
A11.1 3/4" = 1'-0"

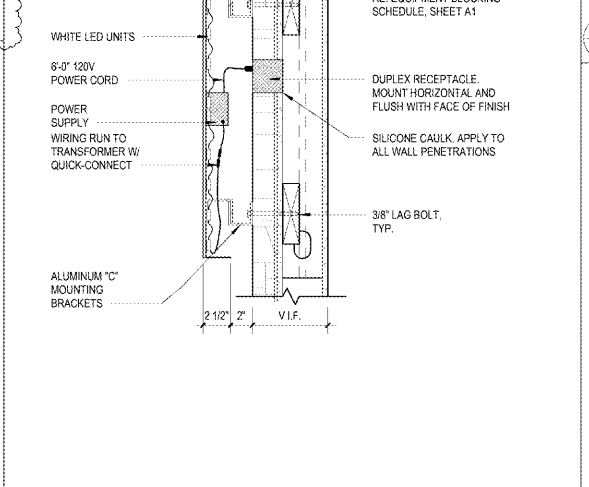

17 LOGO SIGN MOUNTING DETAIL  
A11.1 1 1/2" = 1'-0"

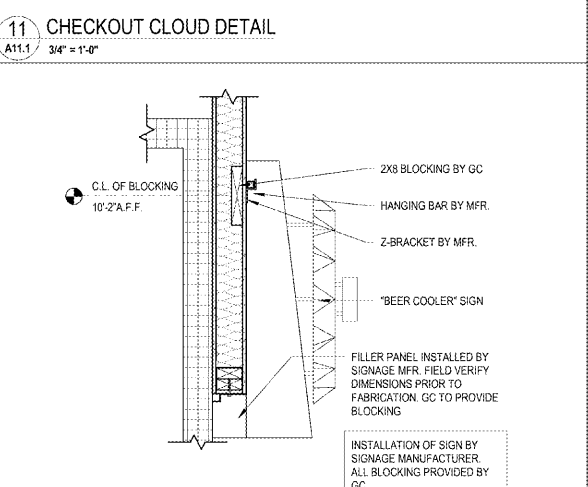

16 BEER COOLER SIGN DETAIL  
A11.1 1" = 1'-0"

**WAWA**

1925 Respect Ave.  
Oxandale, VA 22134  
(407) 668-1100  
(407) 668-9101  
www.wawa.com

**Chalaci & Peterson**  
Architects Engineers Planners

CLIENT NAME: **WAWA**  
280 W. BALTIMORE PIKE  
WAWA, PA 19063

PROJECT NAME: **U45-VA V2018 01-MA STORE #8647-PHM**  
PARRHAM RD. & THREE CHOFT RD.  
HENRICO, VA

REVISION SCHEDULE

No.	Description	Date
1	PERMIT SET	09/21/2018
2	REV V2018 01	01/29/2019
3	REV V2018 01	01/29/2019
4	REV V2018 01	01/29/2019
5	REV V2018 01	01/29/2019
6	REV V2018 01	01/29/2019
7	REV V2018 01	01/29/2019
8	REV V2018 01	01/29/2019
9	REV V2018 01	01/29/2019
10	REV V2018 01	01/29/2019
11	REV V2018 01	01/29/2019
12	REV V2018 01	01/29/2019
13	REV V2018 01	01/29/2019
14	REV V2018 01	01/29/2019
15	REV V2018 01	01/29/2019
16	REV V2018 01	01/29/2019
17	REV V2018 01	01/29/2019
18	REV V2018 01	01/29/2019
19	REV V2018 01	01/29/2019
20	REV V2018 01	01/29/2019

PROJECT NO: 2180130  
DATE: 09-21-2018  
DRAWN: [Blank]  
CHECKED: [Blank]  
DATE: 09-21-2018  
DRAWN: [Blank]  
CHECKED: [Blank]

**A11.1**

INTERIOR DETAILS