

**TIME CLOCKS 12**  
NOT TO SCALE **E-400**

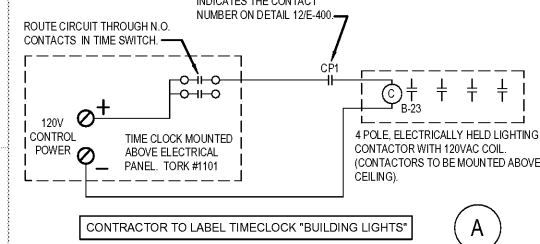

**CONTRACTOR TO LABEL TIMECLOCK "BUILDING LIGHTS"** (A)

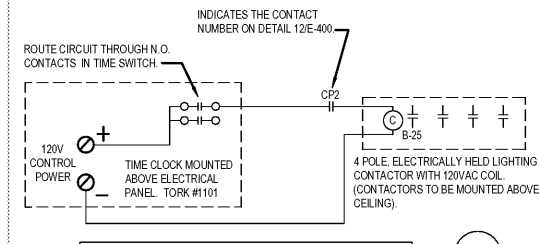

**CONTRACTOR TO LABEL TIMECLOCK "DRIVE THROUGH"** (B)

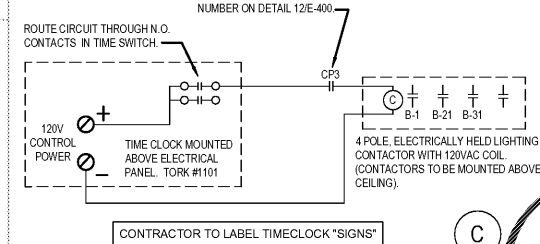

**CONTRACTOR TO LABEL TIMECLOCK "SIGNS"** (C)

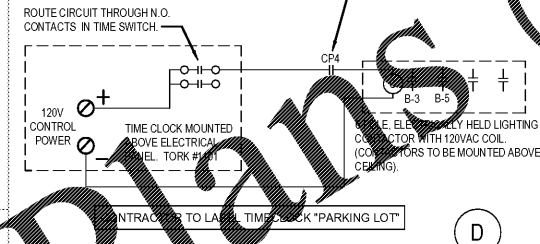

**CONTRACTOR TO LABEL TIMECLOCK "PARKING LOT"** (D)

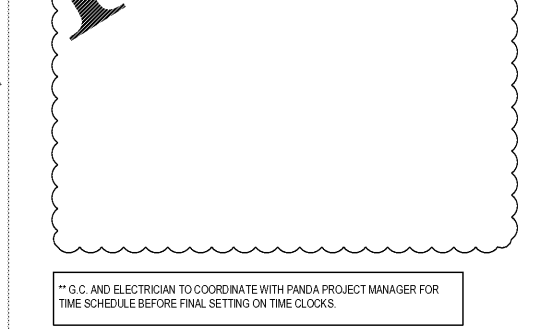

**TIME CLOCKS 11**  
NOT TO SCALE **E-400**

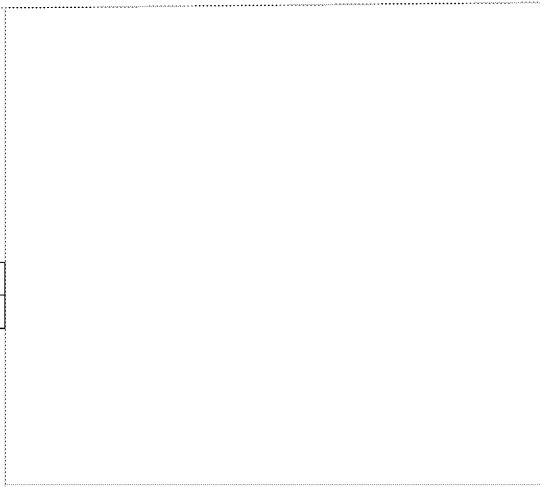

**FREEZER LTG & DOOR HTR WIRING DIAGRAM 10**  
NOT TO SCALE **E-400**

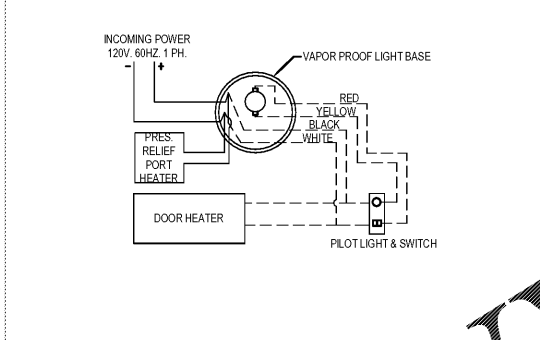

**CONDENSING UNIT 7**  
NOT TO SCALE **E-400**

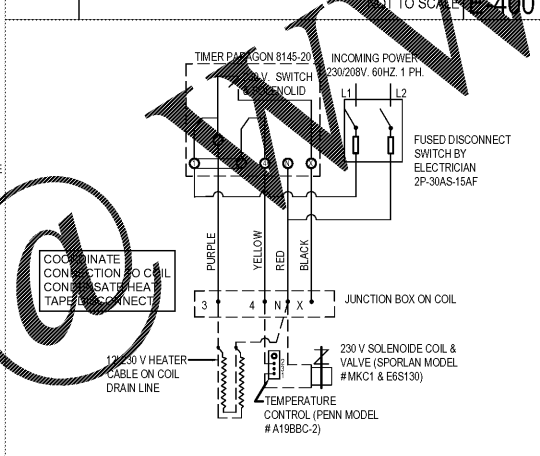

**FREEZER EVAPORATOR COIL 9**  
NOT TO SCALE **E-400**

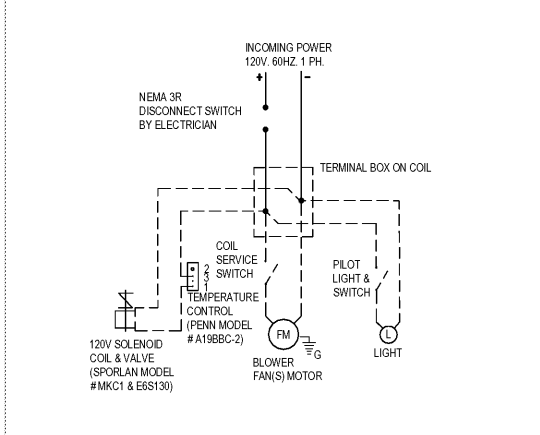

**COOLER EVAPORATOR COIL 8**  
NOT TO SCALE **E-400**

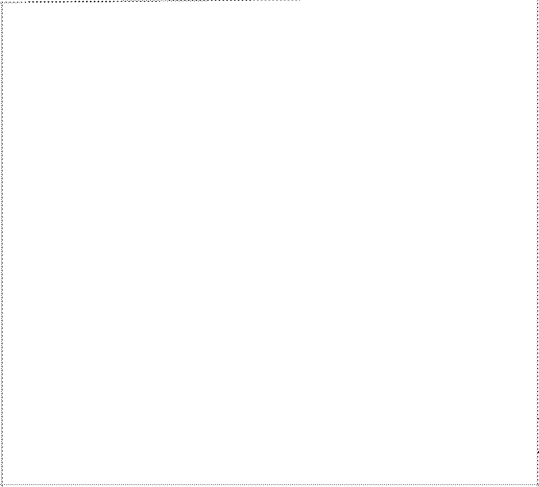

**WIC / WIF WIRING DIAGRAM NOTES 6**  
NOT TO SCALE **E-400**

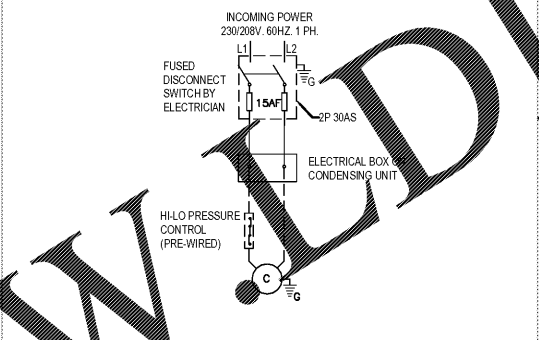

**NOT USED 5**  
NOT TO SCALE **E-400**

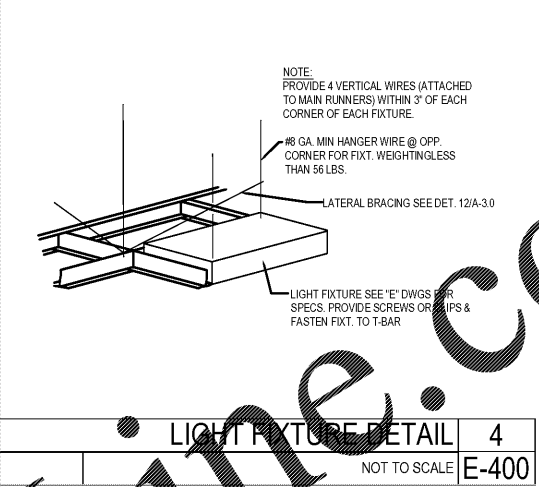

**LIGHT FIXTURE DETAIL 4**  
NOT TO SCALE **E-400**

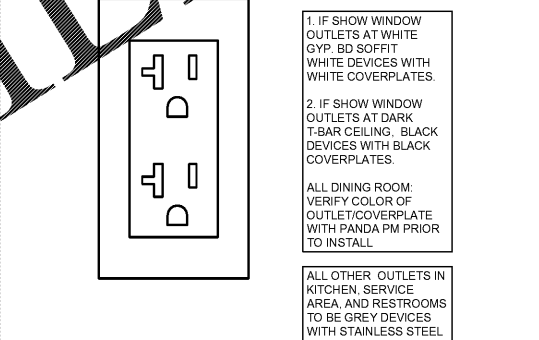

**RECEPT. DIAGRAM 3**  
NOT TO SCALE **E-400**

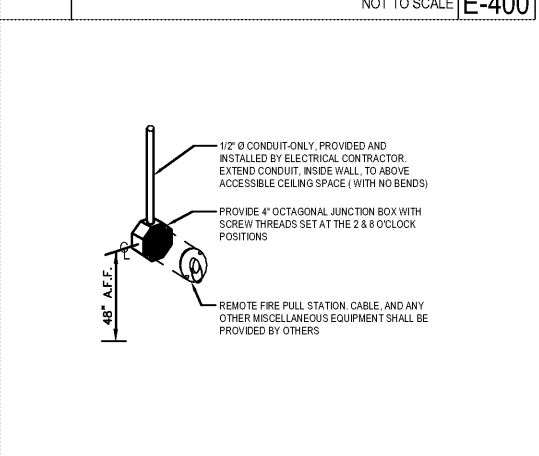

**ANSUL PULL STATION DETAIL 2**  
NOT TO SCALE **E-400**

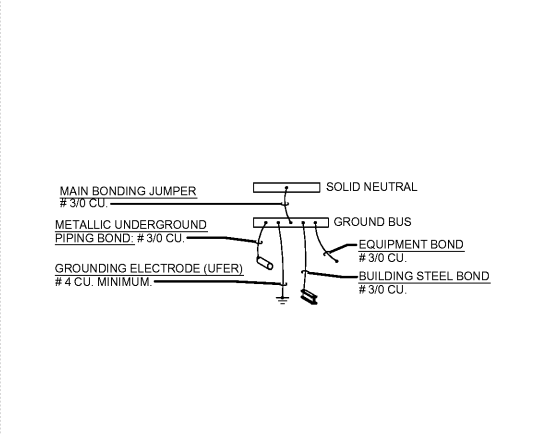

**'MDP' GROUNDING DETAIL 1**  
NOT TO SCALE **E-400**



PANDA EXPRESS, INC.  
1683 Walnut Grove Ave.  
Rosemead, California  
91770  
Telephone: 626.799.9898  
Facsimile: 626.372.8288

All ideas, designs, arrangement and plans indicated or represented by this drawing are the property of Panda Express Inc. and were created for use on this specific project. None of these ideas, designs, arrangements or plans may be used by or disclosed to any person, firm, or corporation without the written permission of Panda Express Inc.

REVISIONS:  
Δ JURISDICTIONAL COMMENTS 11-29-18

ISSUE DATE:  
1st ISSUE FOR BUILDING PERMIT 08-16-18  
2nd ISSUE FOR BD 11-29-18

DRAWN BY: RR  
PANDA PROJECT #: S8-19-D6558  
ARCH PROJECT #: 1804

Project No. PE1804  
**Kurzynski & Associates**  
CONSULTING ENGINEERS  
2800 Lebanon Pike Suite 201  
Nashville, Tennessee 37214

**PANDA EXPRESS**  
US 98 and PORTSIDE DRIVE  
3868 GULF BREEZE PARKWAY  
GULF BREEZE, FL  
2200 TRUE - R1 - DAB 12

**E-400**  
HOT - MEDIUM  
ELECTRICAL DETAILS, DIAGRAMS

Order Plans