



PANDA RESTAURANT GROUP INC.
1683 Walnut Grove Ave.
Rosemead, California
91770
Telephone: 626.799.9898
Facsimile: 626.372.8288

All ideas, designs, arrangement and plans indicated or represented by this drawing are the property of Panda Express Inc. and were created for use on this specific project. None of these ideas, designs, arrangements or plans may be used by or disclosed to any person, firm or corporation without the written permission of Panda Express Inc.

REVISIONS:

ISSUE DATE:
1 ISSUED FOR BID & PERMIT 12-11-18
2 BID SET 01-30-19

DRAWN BY: JO
PANDA PROJECT # S8-19-D6573
ARCH PROJECT # P7336

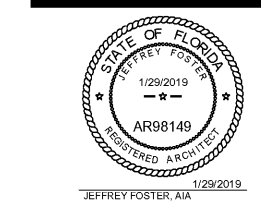
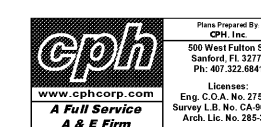

PANDA EXPRESS
WARM & WELCOME 2200
ATLANTIC BLVD & MARKETPLACE DR
JACKSONVILLE, FL 32225

A-402

ARCHITECTURAL DETAILS

TRUE WARM & WELCOME 2200

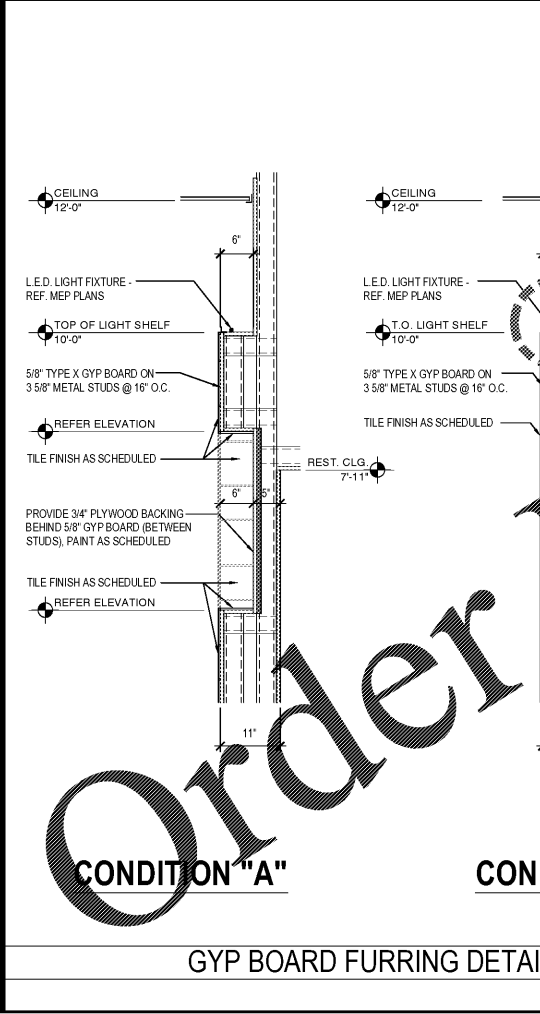
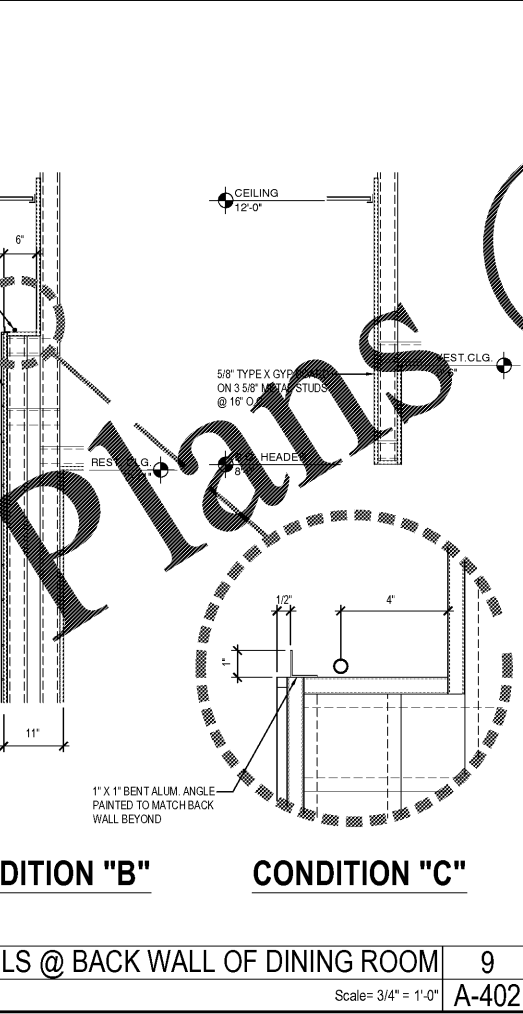
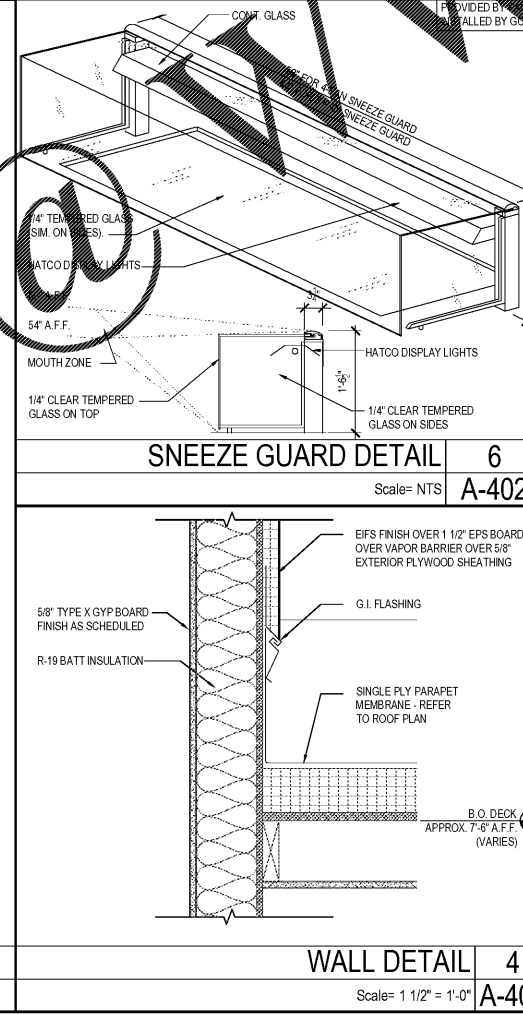
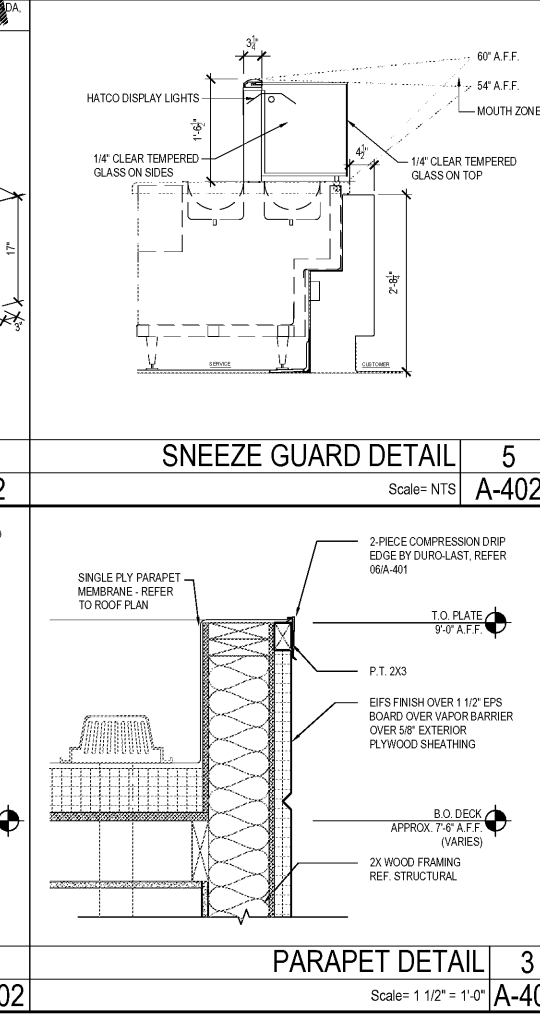
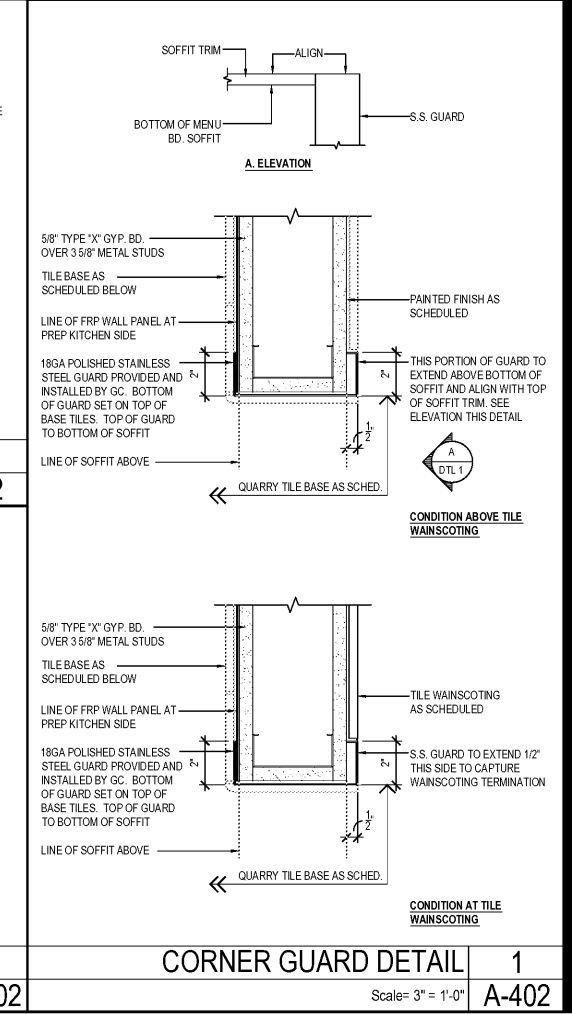
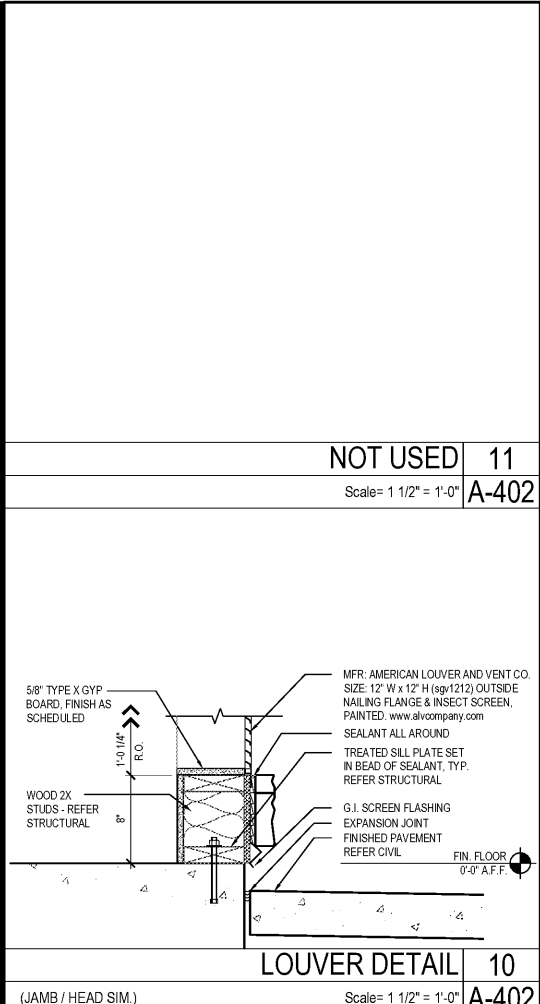
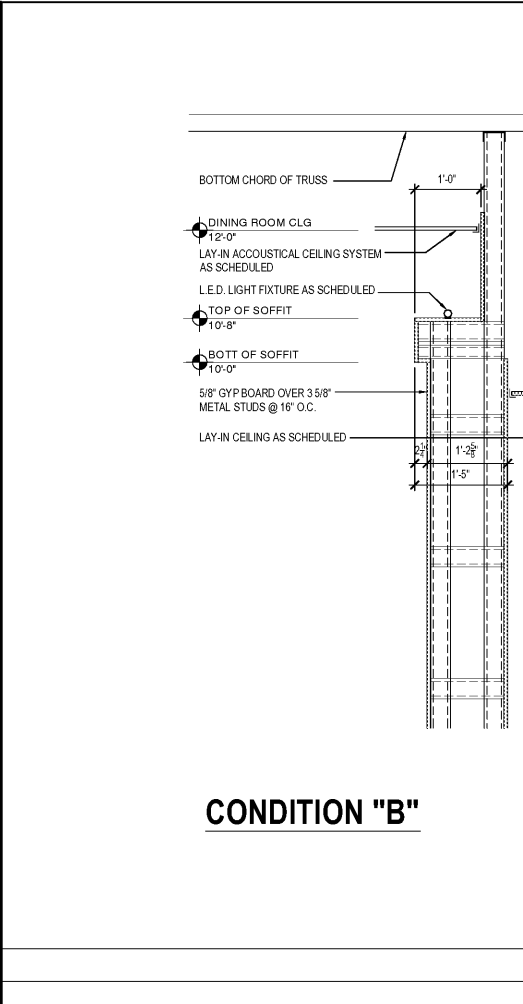
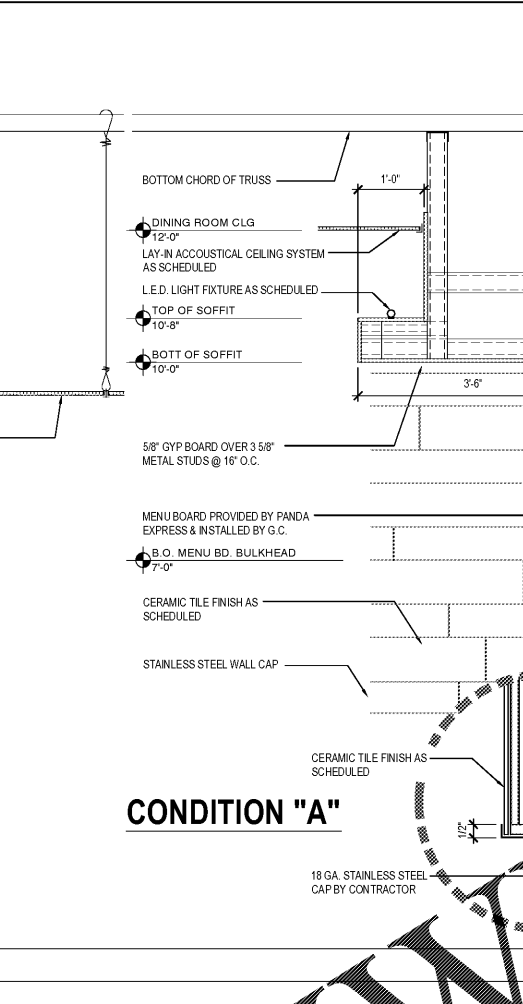
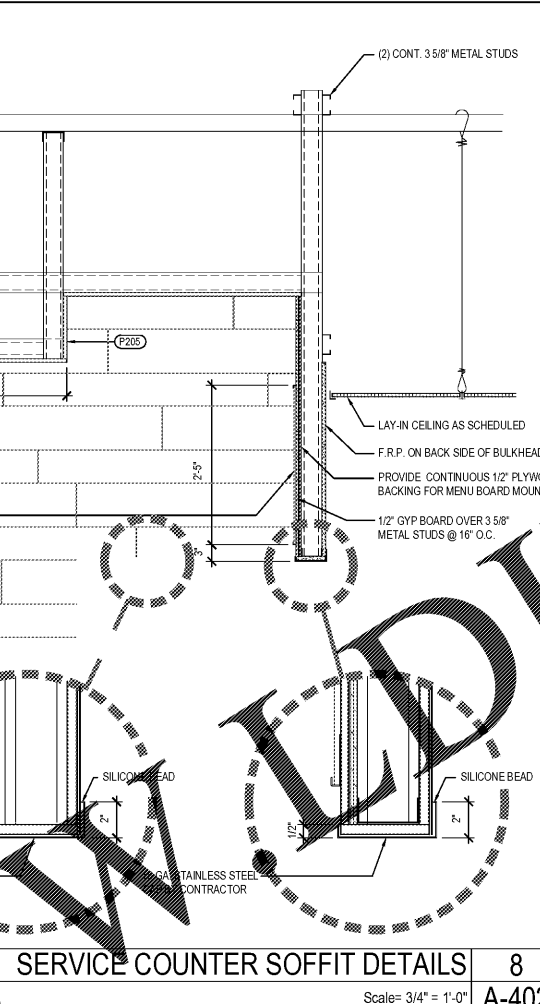
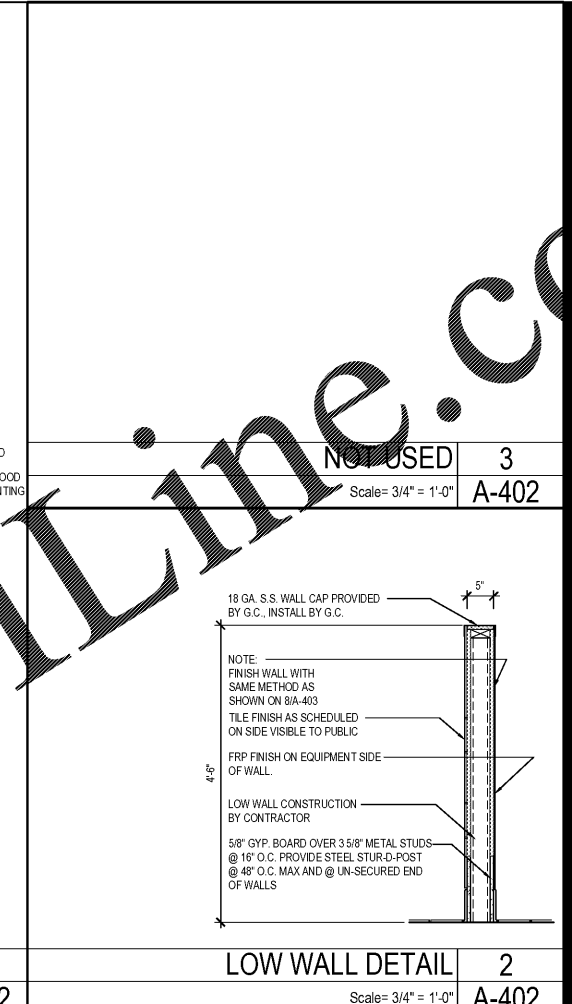

Order Plans

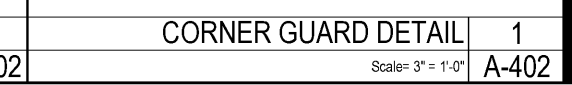
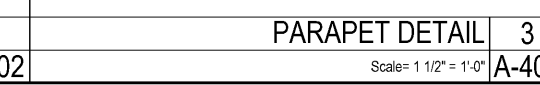
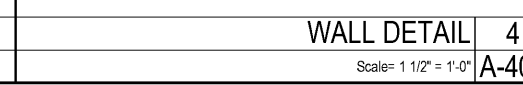
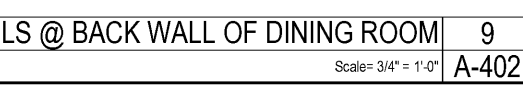
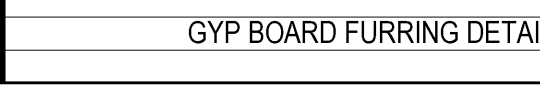

Order Plans