

RACK MOUNT FIBER ENCLOSURE

1 NEW 2 RU RACK MOUNT FIBER ENCLOSURE AND FIBER CASSETTE ADAPTER PANEL DETAIL  
SCALE: NONE

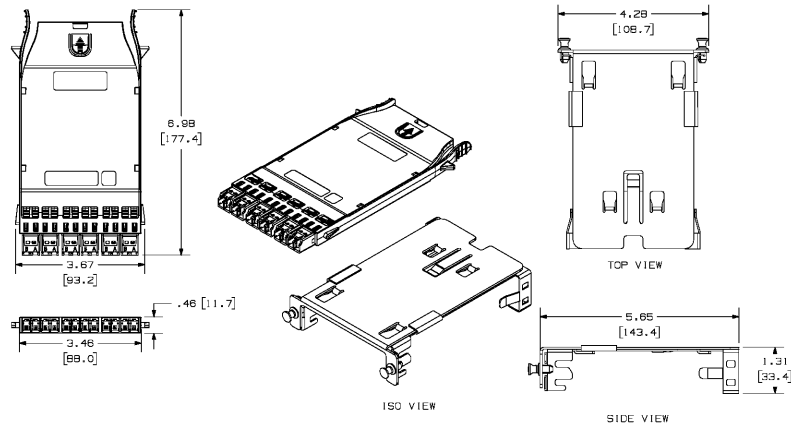

FIBER CASSETTE AND ADAPTER - SIX DUPLEX LC CONNECTORS

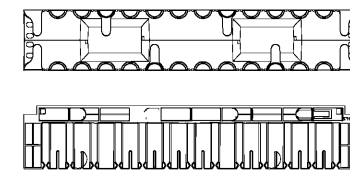

2 RU SINGLE-SIDED HORIZONTAL CABLE MANAGER

2 NEW HORIZONTAL CABLE MANAGEMENT  
SCALE: NONE

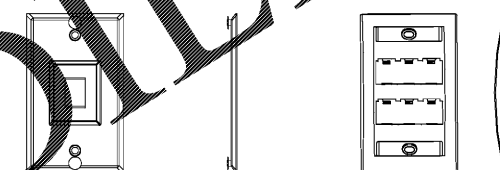

3 NEW SINGLE PORT WALL PLATE AND SIX PORT TYPICAL TELECOM FACEPLATES  
SCALE: NONE

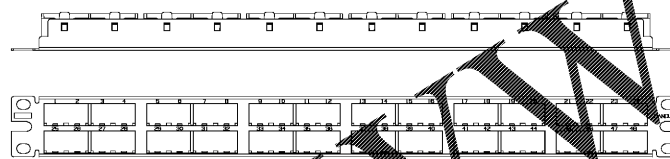
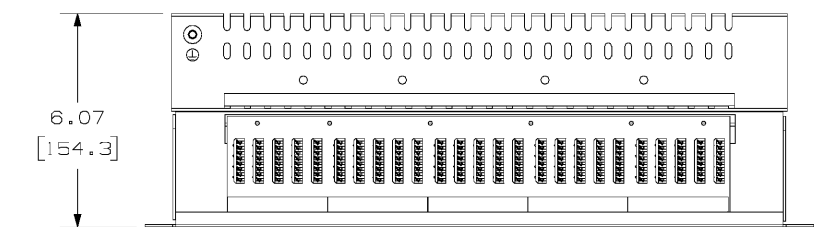

5 NEW RACK MOUNT 1RU, HIGH DENSITY METAL MODULAR PATCH PANEL  
SCALE: NONE

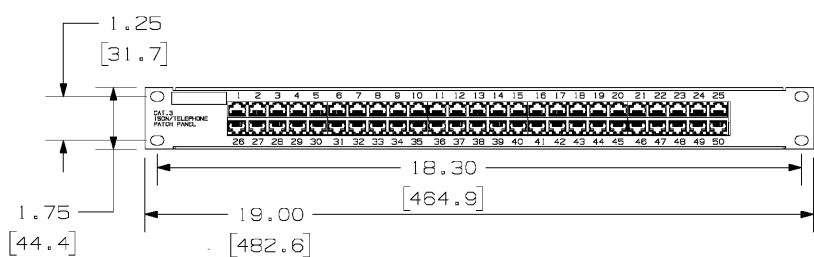

PORT WIRING SCHEME

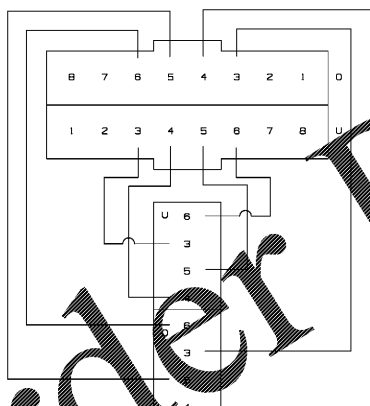

6 NEW CATEGORY 3 ISDN/TELEPHONE 50 PORT PATCH PANEL  
SCALE: NONE

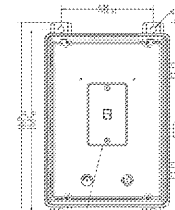
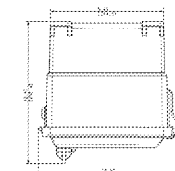
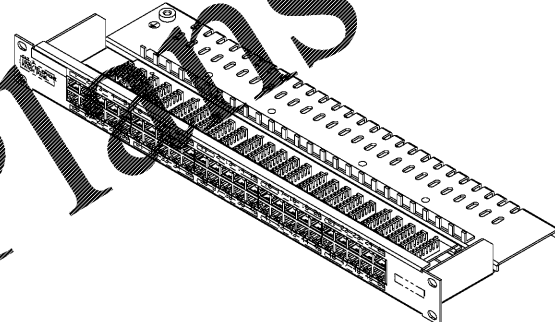

Note: Dimensions in Brackets are in Millimeters.

4 WEATHERPROOF OUTDOOR TELEPHONE ENCLOSURE (CALLBOX)  
SCALE: NONE

WILSON AIR CENTER  
NORTH TERMINAL  
CHARLOTTE, NC  
5327 WINDS FELLOW DRIVE  
CHARLOTTE, NC 28217

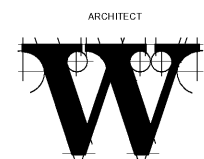
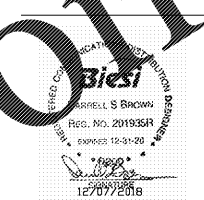

THE WILSON GROUP  
P O BOX 5510  
CHARLOTTE, NC 28299  
(704) 331-9747

CIVIL ENGINEER  
TALBERT, BRIGHT & ELLINGTON  
3825 WHITEHALL PARK DRIVE, SUITE 210  
CHARLOTTE, NC 28273  
(704) 428-6070 FIRM NO. C-1163

STRUCTURAL ENGINEER  
STEWART  
101 N. TRYON ST., SUITE 1400  
CHARLOTTE, NC 28202  
(704) 999-3523 FIRM NO. C-1051

MECHANICAL, ELECTRICAL, PLUMBING & FIRE PROTECTION ENGINEER  
SABER ENGINEERING  
2923 S. TRYON ST., SUITE 280  
CHARLOTTE, NC 28203  
(704) 373-0088 FIRM NO. C-2130

LANDSCAPE ARCHITECT  
URBAN DESIGN PARTNERS  
1318 E. CENTRAL AVENUE  
CHARLOTTE, NC 28205  
(704) 334-3303 FIRM NO. C-TBD

COMMUNICATIONS INFRASTRUCTURE  
DB CONSULTING  
246 LOVES FARM ROAD  
BLACKSBURG, SC 29702  
(704) 497-7228 FIRM NO. C-TBD

REVISIONS

DATE: DECEMBER 07, 2018  
PROJECT NUMBER: 9197-000

SHEET TITLE: TELECOM COMPONENT DETAILS

SHEET NUMBER: TC-003

"FOR OFFICIAL USE ONLY"  
"WARNING: This document is FOR OFFICIAL USE ONLY (FOUO). It contains information that may be exempt from public release under the Freedom of Information Act (5 U.S.C. 552). It is to be controlled, stored, handled, transmitted, distributed and disposed of in accordance with DHS policy relating to FOUO information and is not to be released to the public or other personnel who do not have a valid 'need-to-know' without prior approval of an authorized DHS official."

Order Planners @