

C1  
C-602

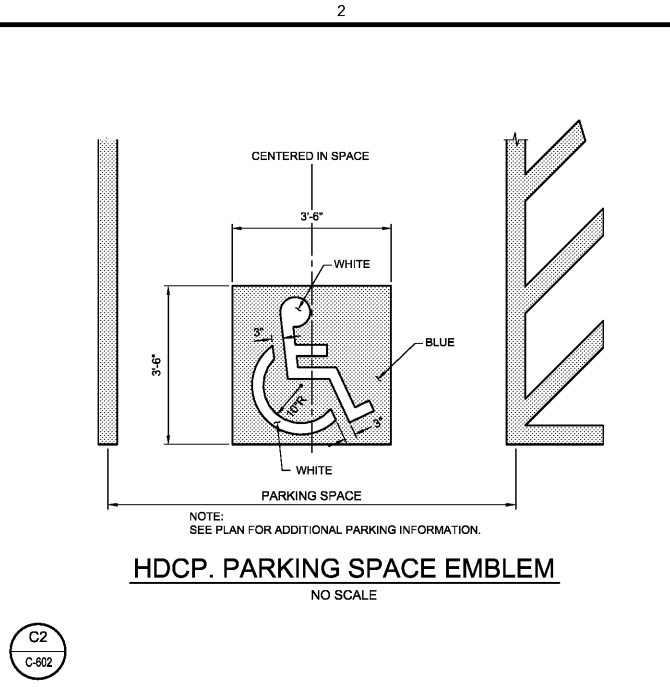

C2  
C-602

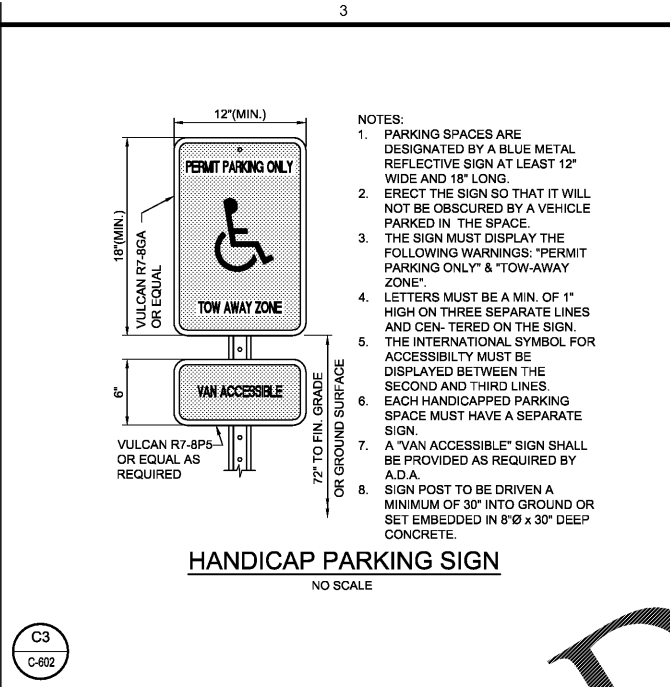

C3  
C-602

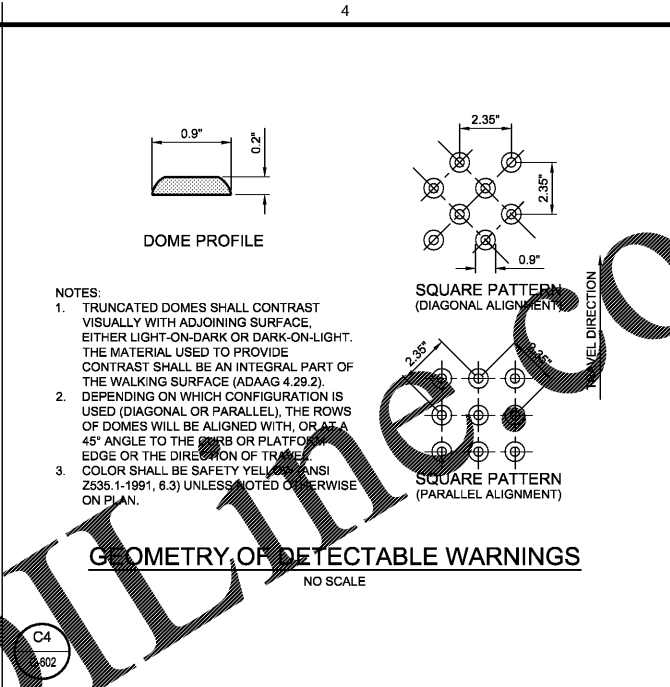

C4  
C-602

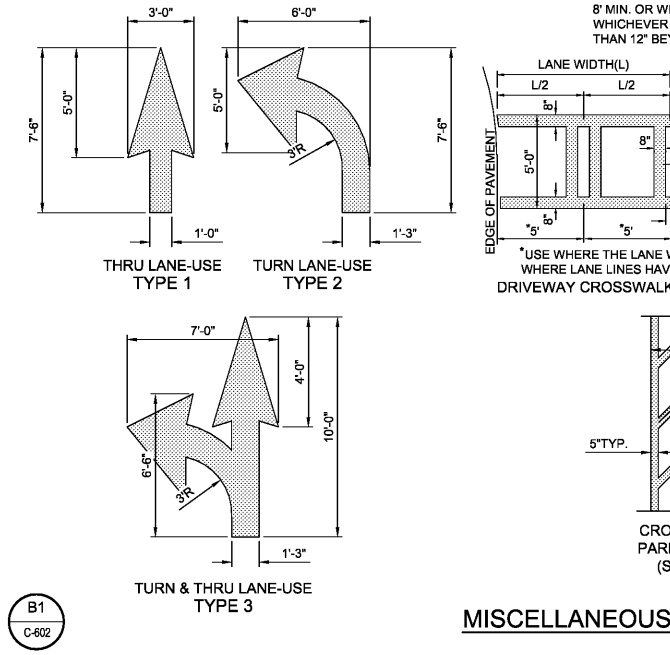

B1  
C-602

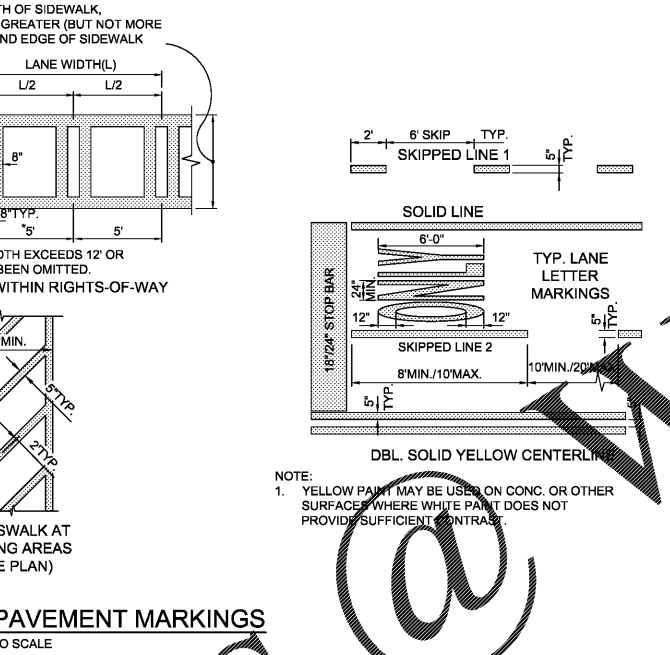

B3  
C-602

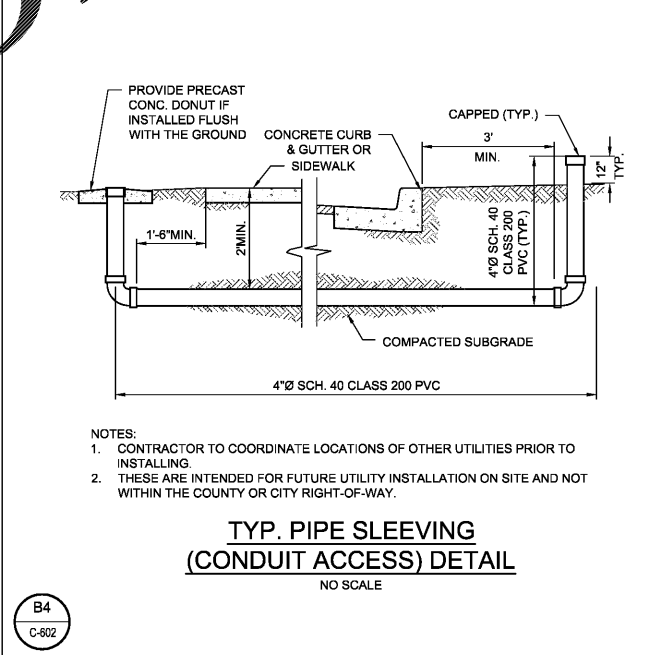

B4  
C-602

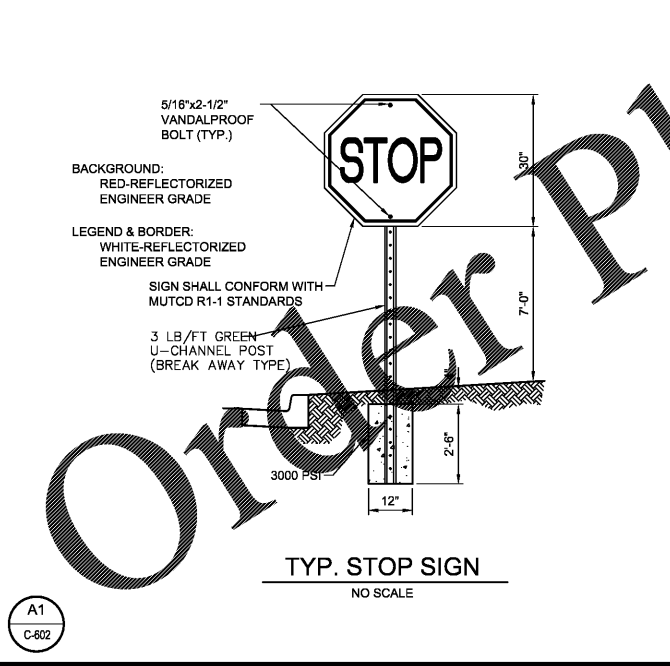

A1  
C-602

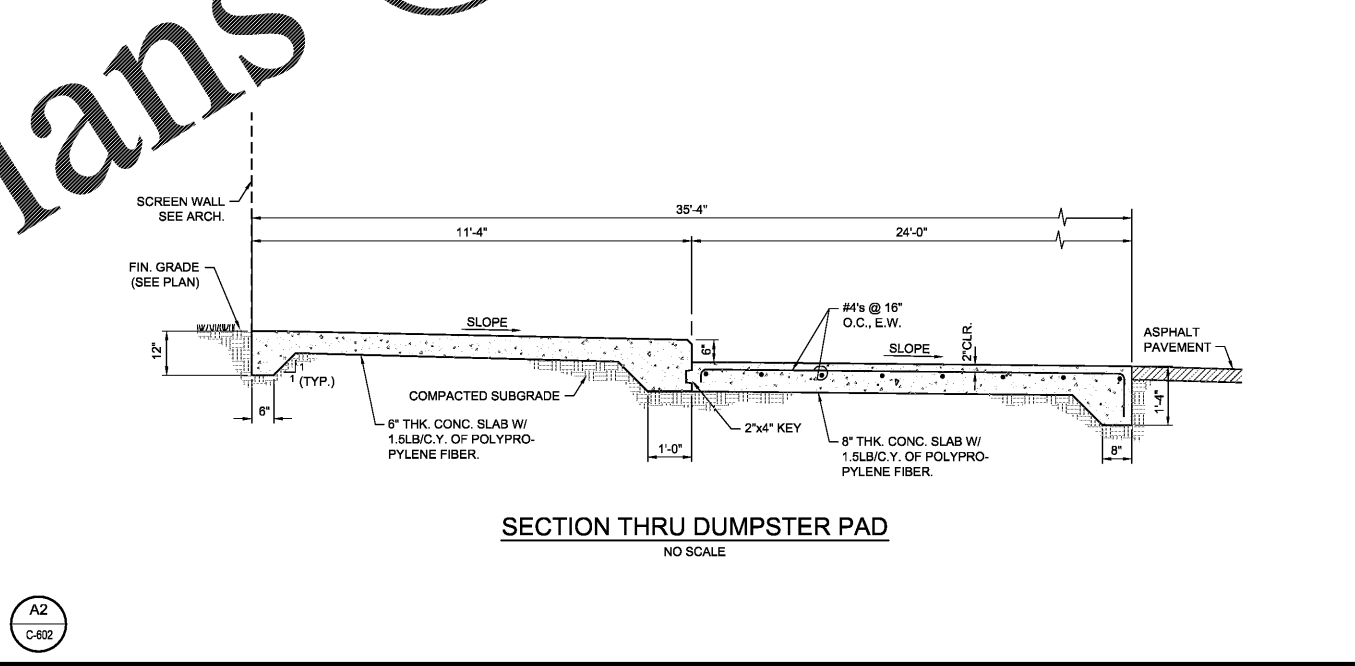

A2  
C-602

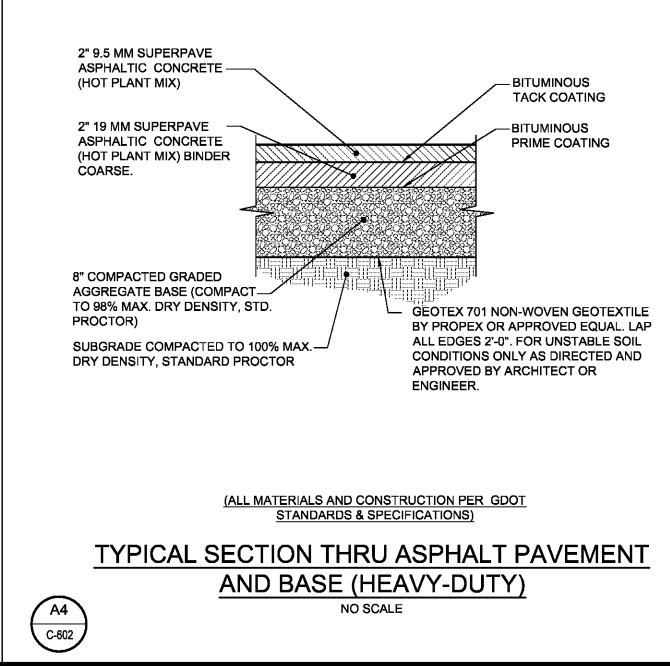

A4  
C-602

1980  
JOHNSON, LASCHNER & ASSOCIATES, P.C.  
ARCHITECTS ENGINEERS PLANNERS  
1000 W. BROAD ST., SUITE 1000, AUGUSTA, GA 30901  
TEL: (706) 724-5756 • TEL: (843) 619-4656  
FAX: (706) 724-3935  
WWW.THEJLAGROUP.COM

CLIENT: AUGUSTA, GA  
928 TELFAIR STREET, AUGUSTA, GA 30901

PROJECT NAME: FIRE STATION #2

PROJECT LOCATION: 928 TELFAIR ST., AUGUSTA, GA 30901

GEORGIA  
Professional Engineer  
No. 12345  
12/29/12  
Professional Seal

REV	DATE	BY	DESCRIPTION
0	02/29/18	WTB	ISSUED FOR PERMITTING

PROJECT NO. 3042.1604  
DRAWN BY: WTB  
CHECKED BY: WLD  
DATE: 10/18/17  
SHEET TITLE: CONSTRUCTION DETAILS - 2 OF 6  
SCALE: AS NOTED  
DRAWING NO. C-602  
REV. 0