

William J. Akers
383 Maplewood
St. Louis, MO 63119
Phone (314) 772-1782
Fax (314) 577-2501

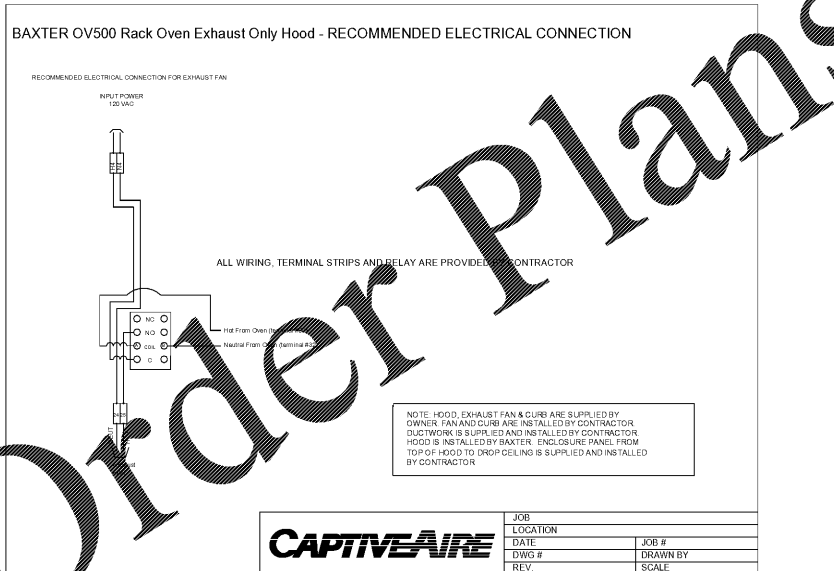

Engineering Consultant

INTEGRATED TYPE II HOOD FOR RACK OVEN

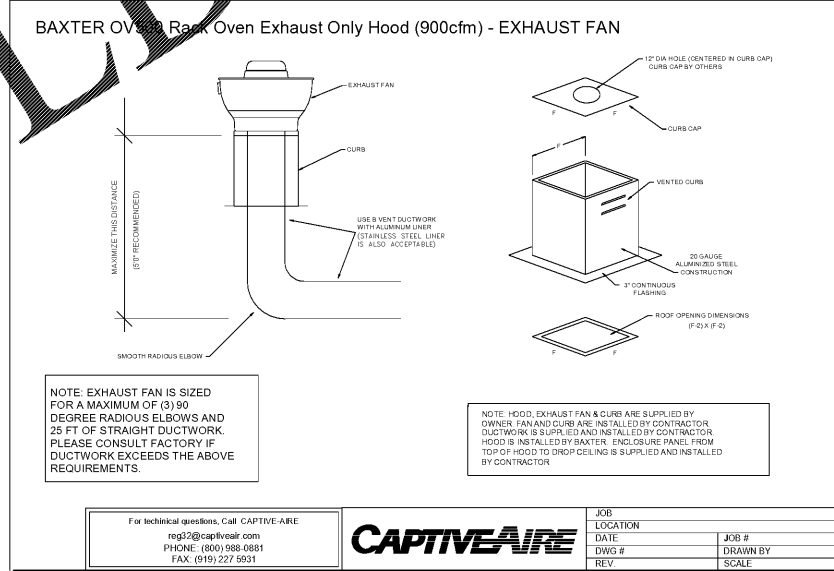
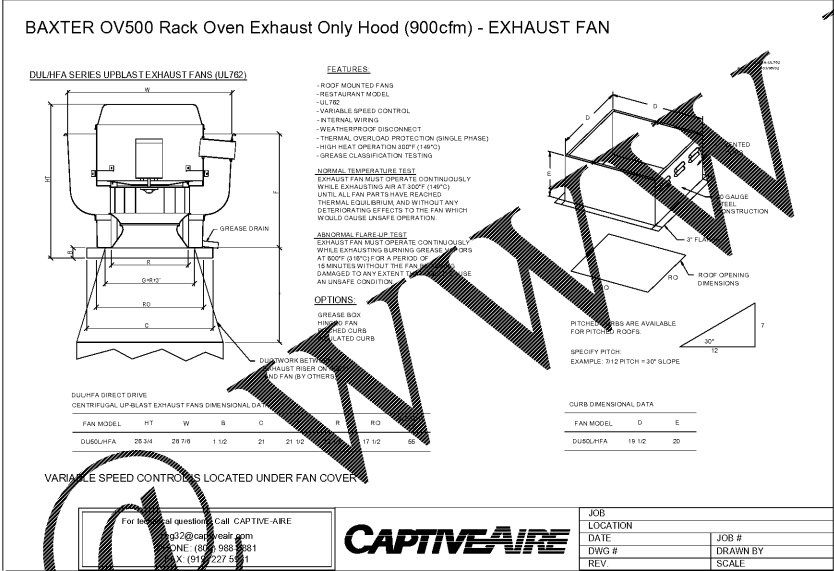
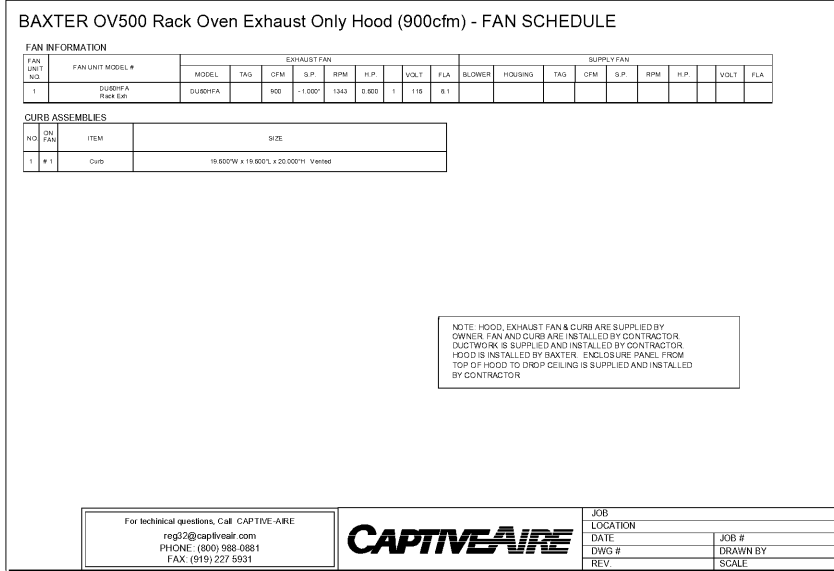
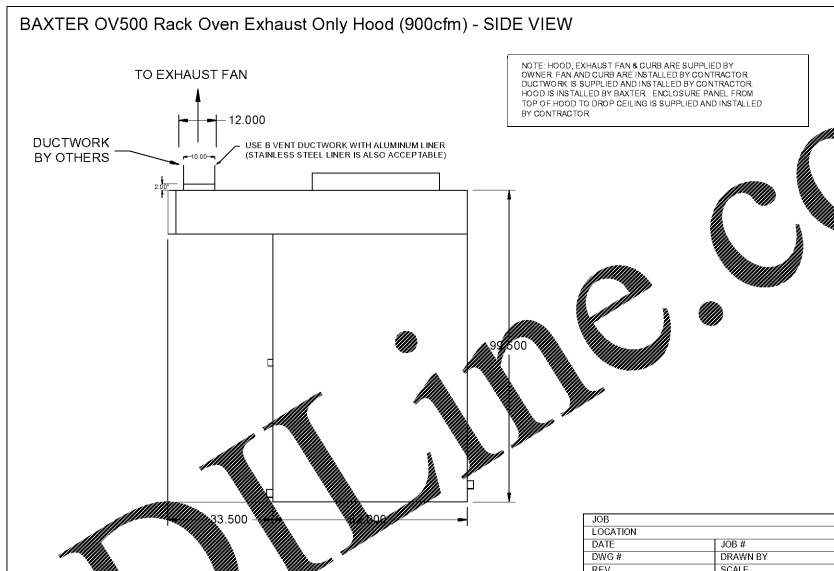
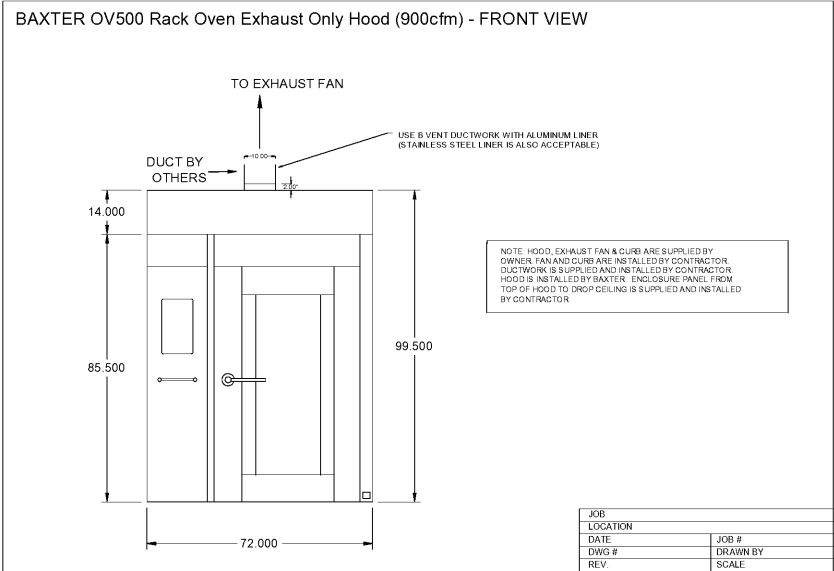
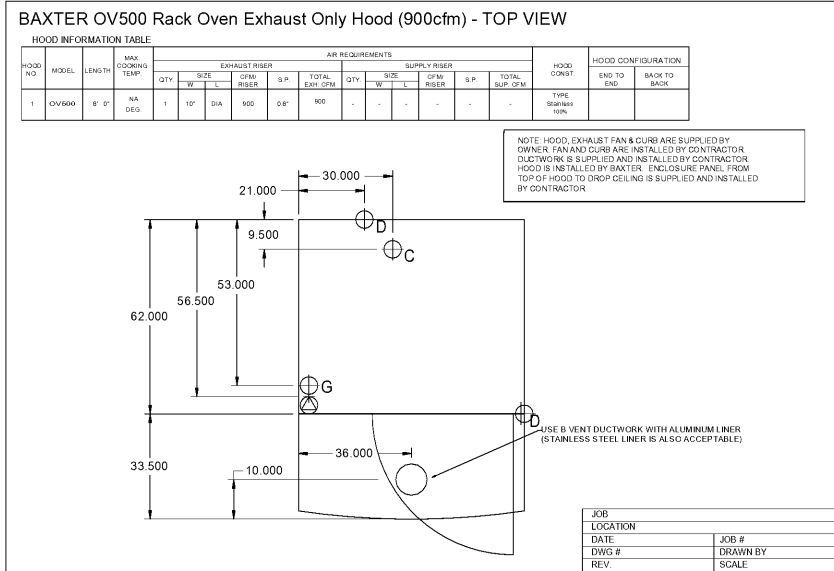

Order Plans

Bakery Cafe #6119
6351 MANATEE AVE. W,
BRADENTON, FL 34209

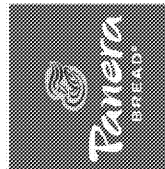

| NO. | DESCRIPTION | DATE |
|-----|-------------|------|
| | | |
| | | |
| | | |
| | | |

DETAILS

Project Number: 449-18
 Drawn: Checked:
 AC MG **M301**
 Issue Date: 10/01/18
 DPM: DM: CPM:
 BS: DM: ME