

1 FIRE PROTECTION FOUNDATION WALL SERVICE ENTRY SCHEMATIC
NOT TO SCALE

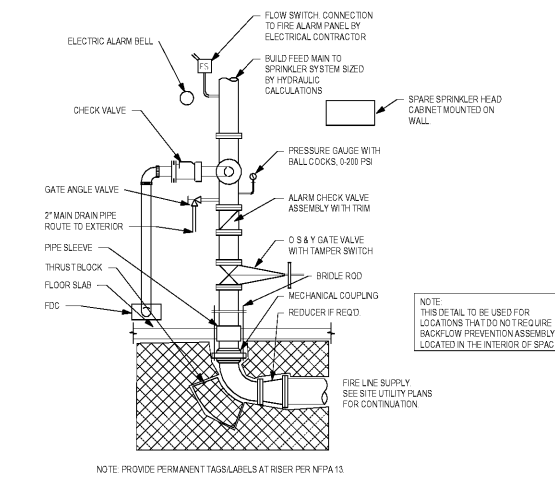

2 FIRE RISER DETAIL
NOT TO SCALE

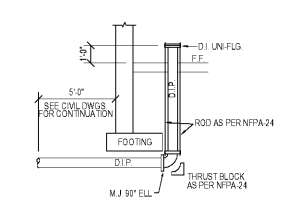

3 FIRE SERVICE ENTRANCE DETAIL
1" = 10'-0"

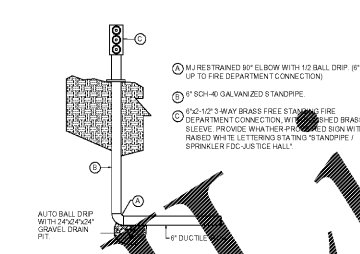

4 FREE STANDING FIRE RISER SCHEMATIC
NOT TO SCALE

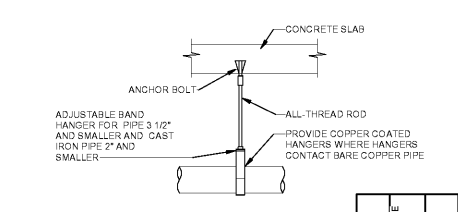

PROVIDE UPPER ATTACHMENT AS REQUIRED FOR CASES NOT SHOWN HERE. DO NOT INSTALL HANGER INSIDE INSULATION OR OTHERWISE PENETRATE VAPOR BARRIER. DO NOT HANG ONE PIPE FROM ANOTHER EXCEPT IN CHASIS. SLOPE ALL WATER PIPING SLIGHTLY TOWARD DRAINABLE LOCATIONS. HANGER SPACING FOR PIPE SIZE AS INDICATED ON TABLE.

PIPE SIZE	COPPER PIPE HANGER SPACING	STEEL PIPE HANGER SPACING
1/2"	5'-0"	7'-0"
3/4"	5'-0"	7'-0"
1"	6'-0"	7'-0"
1 1/4"	7'-0"	8'-0"
1 1/2"	8'-0"	9'-0"
2"	8'-0"	10'-0"
2 1/2"	10'-0"	11'-0"
3"	11'-0"	12'-0"
4"	12'-0"	12'-0"

CAST IRON: 10' AND WITHIN 1'-0" OF ALL JOINTS. ROD SIZES FOR PIPE SIZE: 2" AND SMALLER = 3/8" x 1/2" TO 3" = 1/2", 4" = 5/8", 6" = 3/4", 8" AND LARGER = 7/8". LOCATE HANGERS WITHIN 1'-0" OF VALVES AND FITTINGS. PROVIDE SUPPLEMENTARY STEEL STRUTS BETWEEN JOISTS IF REQUIRED. LOCATE HANGERS WITHIN 1'-0" OF EQUIPMENT CONNECTIONS. ANCHOR WATER PIPE AGAINST SWAYING DUE TO CHANGES IN WATER VELOCITY. CHAINS AND PERFORATED STRAP IRON AND STEEL ARE NOT ACCEPTABLE. DO NOT SUSPEND PIPE FROM JOIST BRACING MEMBERS. REFER TO CODE AND SPECIFICATIONS FOR FURTHER INFORMATION. PROVIDE SEISMIC BRACING (AS REQUIRED BY LOCAL AUTHORITIES). TRAPEZE HANGERS MAY BE USED FOR MULTIPLE PARALLEL PIPES. SEE "TRAPEZE PIPE HANGER DETAIL".

5 PIPE HANGER - ANCHOR
NOT TO SCALE

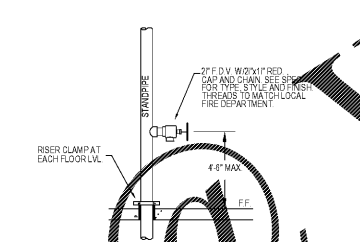

6 INTERMEDIATE LEVEL FIRE DEPARTMENT VALVE DETAIL
1" = 10'-0"

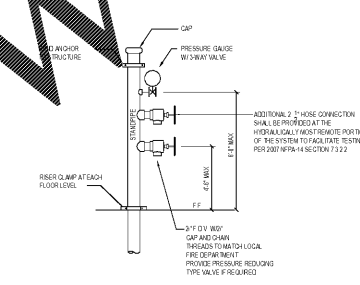

7 TOP LEVEL FIRE DEPARTMENT VALVE DETAIL
1" = 10'-0"

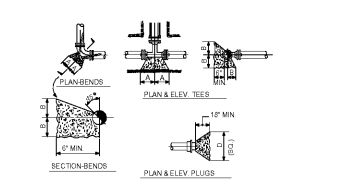

THRUST BLOCKS
CAST IRON, DUCTILE IRON & CARBON STEEL PIPE

SIZE	1/2" BEND	1" BEND	1 1/2" BEND	2" BEND	3" BEND	4" BEND	6" BEND	8" BEND	10" BEND	12" BEND	14" BEND	16" BEND	18" BEND	20" BEND	24" BEND	30" BEND	36" BEND	42" BEND	48" BEND	60" BEND	72" BEND	90" BEND	108" BEND	120" BEND	144" BEND	168" BEND	192" BEND	216" BEND	240" BEND	270" BEND	300" BEND	360" BEND																																																																																																																																																																																																																																																																																																																																																																																								
A	1 1/2"	2 1/2"	3 1/2"	4 1/2"	5 1/2"	6 1/2"	8 1/2"	10 1/2"	12 1/2"	14 1/2"	16 1/2"	18 1/2"	20 1/2"	24 1/2"	30 1/2"	36 1/2"	42 1/2"	48 1/2"	60 1/2"	72 1/2"	90 1/2"	108 1/2"	120 1/2"	144 1/2"	168 1/2"	192 1/2"	216 1/2"	240 1/2"	270 1/2"	300 1/2"	360 1/2"	420 1/2"	480 1/2"	600 1/2"	720 1/2"	840 1/2"	960 1/2"	1080 1/2"	1200 1/2"	1440 1/2"	1680 1/2"	1920 1/2"	2160 1/2"	2400 1/2"	2700 1/2"	3000 1/2"	3600 1/2"	4200 1/2"	4800 1/2"	6000 1/2"	7200 1/2"	8400 1/2"	9600 1/2"	10800 1/2"	12000 1/2"	14400 1/2"	16800 1/2"	19200 1/2"	21600 1/2"	24000 1/2"	27000 1/2"	30000 1/2"	36000 1/2"	42000 1/2"	48000 1/2"	60000 1/2"	72000 1/2"	84000 1/2"	96000 1/2"	108000 1/2"	120000 1/2"	144000 1/2"	168000 1/2"	192000 1/2"	216000 1/2"	240000 1/2"	270000 1/2"	300000 1/2"	360000 1/2"	420000 1/2"	480000 1/2"	600000 1/2"	720000 1/2"	840000 1/2"	960000 1/2"	1080000 1/2"	1200000 1/2"	1440000 1/2"	1680000 1/2"	1920000 1/2"	2160000 1/2"	2400000 1/2"	2700000 1/2"	3000000 1/2"	3600000 1/2"	4200000 1/2"	4800000 1/2"	6000000 1/2"	7200000 1/2"	8400000 1/2"	9600000 1/2"	10800000 1/2"	12000000 1/2"	14400000 1/2"	16800000 1/2"	19200000 1/2"	21600000 1/2"	24000000 1/2"	27000000 1/2"	30000000 1/2"	36000000 1/2"	42000000 1/2"	48000000 1/2"	60000000 1/2"	72000000 1/2"	84000000 1/2"	96000000 1/2"	108000000 1/2"	120000000 1/2"	144000000 1/2"	168000000 1/2"	192000000 1/2"	216000000 1/2"	240000000 1/2"	270000000 1/2"	300000000 1/2"	360000000 1/2"	420000000 1/2"	480000000 1/2"	600000000 1/2"	720000000 1/2"	840000000 1/2"	960000000 1/2"	1080000000 1/2"	1200000000 1/2"	1440000000 1/2"	1680000000 1/2"	1920000000 1/2"	2160000000 1/2"	2400000000 1/2"	2700000000 1/2"	3000000000 1/2"	3600000000 1/2"	4200000000 1/2"	4800000000 1/2"	6000000000 1/2"	7200000000 1/2"	8400000000 1/2"	9600000000 1/2"	10800000000 1/2"	12000000000 1/2"	14400000000 1/2"	16800000000 1/2"	19200000000 1/2"	21600000000 1/2"	24000000000 1/2"	27000000000 1/2"	30000000000 1/2"	36000000000 1/2"	42000000000 1/2"	48000000000 1/2"	60000000000 1/2"	72000000000 1/2"	84000000000 1/2"	96000000000 1/2"	108000000000 1/2"	120000000000 1/2"	144000000000 1/2"	168000000000 1/2"	192000000000 1/2"	216000000000 1/2"	240000000000 1/2"	270000000000 1/2"	300000000000 1/2"	360000000000 1/2"	420000000000 1/2"	480000000000 1/2"	600000000000 1/2"	720000000000 1/2"	840000000000 1/2"	960000000000 1/2"	1080000000000 1/2"	1200000000000 1/2"	1440000000000 1/2"	1680000000000 1/2"	1920000000000 1/2"	2160000000000 1/2"	2400000000000 1/2"	2700000000000 1/2"	3000000000000 1/2"	3600000000000 1/2"	4200000000000 1/2"	4800000000000 1/2"	6000000000000 1/2"	7200000000000 1/2"	8400000000000 1/2"	9600000000000 1/2"	10800000000000 1/2"	12000000000000 1/2"	14400000000000 1/2"	16800000000000 1/2"	19200000000000 1/2"	21600000000000 1/2"	24000000000000 1/2"	27000000000000 1/2"	30000000000000 1/2"	36000000000000 1/2"	42000000000000 1/2"	48000000000000 1/2"	60000000000000 1/2"	72000000000000 1/2"	84000000000000 1/2"	96000000000000 1/2"	108000000000000 1/2"	120000000000000 1/2"	144000000000000 1/2"	168000000000000 1/2"	192000000000000 1/2"	216000000000000 1/2"	240000000000000 1/2"	270000000000000 1/2"	300000000000000 1/2"	360000000000000 1/2"	420000000000000 1/2"	480000000000000 1/2"	600000000000000 1/2"	720000000000000 1/2"	840000000000000 1/2"	960000000000000 1/2"	1080000000000000 1/2"	1200000000000000 1/2"	1440000000000000 1/2"	1680000000000000 1/2"	1920000000000000 1/2"	2160000000000000 1/2"	2400000000000000 1/2"	2700000000000000 1/2"	3000000000000000 1/2"	3600000000000000 1/2"	4200000000000000 1/2"	4800000000000000 1/2"	6000000000000000 1/2"	7200000000000000 1/2"	8400000000000000 1/2"	9600000000000000 1/2"	10800000000000000 1/2"	12000000000000000 1/2"	14400000000000000 1/2"	16800000000000000 1/2"	19200000000000000 1/2"	21600000000000000 1/2"	24000000000000000 1/2"	27000000000000000 1/2"	30000000000000000 1/2"	36000000000000000 1/2"	42000000000000000 1/2"	48000000000000000 1/2"	60000000000000000 1/2"	72000000000000000 1/2"	84000000000000000 1/2"	96000000000000000 1/2"	108000000000000000 1/2"	120000000000000000 1/2"	144000000000000000 1/2"	168000000000000000 1/2"	192000000000000000 1/2"	216000000000000000 1/2"	240000000000000000 1/2"	270000000000000000 1/2"	300000000000000000 1/2"	360000000000000000 1/2"	420000000000000000 1/2"	480000000000000000 1/2"	600000000000000000 1/2"	720000000000000000 1/2"	840000000000000000 1/2"	960000000000000000 1/2"	1080000000000000000 1/2"	1200000000000000000 1/2"	1440000000000000000 1/2"	1680000000000000000 1/2"	1920000000000000000 1/2"	2160000000000000000 1/2"	2400000000000000000 1/2"	2700000000000000000 1/2"	3000000000000000000 1/2"	3600000000000000000 1/2"	4200000000000000000 1/2"	4800000000000000000 1/2"	6000000000000000000 1/2"	7200000000000000000 1/2"	8400000000000000000 1/2"	9600000000000000000 1/2"	10800000000000000000 1/2"	12000000000000000000 1/2"	14400000000000000000 1/2"	16800000000000000000 1/2"	19200000000000000000 1/2"	21600000000000000000 1/2"	24000000000000000000 1/2"	27000000000000000000 1/2"	30000000000000000000 1/2"	36000000000000000000 1/2"	42000000000000000000 1/2"	48000000000000000000 1/2"	60000000000000000000 1/2"	72000000000000000000 1/2"	84000000000000000000 1/2"	96000000000000000000 1/2"	108000000000000000000 1/2"	120000000000000000000 1/2"	144000000000000000000 1/2"	168000000000000000000 1/2"	192000000000000000000 1/2"	216000000000000000000 1/2"	240000000000000000000 1/2"	270000000000000000000 1/2"	300000000000000000000 1/2"	360000000000000000000 1/2"	420000000000000000000 1/2"	480000000000000000000 1/2"	600000000000000000000 1/2"	720000000000000000000 1/2"	840000000000000000000 1/2"	960000000000000000000 1/2"	1080000000000000000000 1/2"	1200000000000000000000 1/2"	1440000000000000000000 1/2"	1680000000000000000000 1/2"	1920000000000000000000 1/2"	2160000000000000000000 1/2"	2400000000000000000000 1/2"	2700000000000000000000 1/2"	3000000000000000000000 1/2"	3600000000000000000000 1/2"	4200000000000000000000 1/2"	4800000000000000000000 1/2"	6000000000000000000000 1/2"	7200000000000000000000 1/2"	8400000000000000000000 1/2"	9600000000000000000000 1/2"	10800000000000000000000 1/2"	12000000000000000000000 1/2"	14400000000000000000000 1/2"	16800000000000000000000 1/2"	19200000000000000000000 1/2"	21600000000000000000000 1/2"	24000000000000000000000 1/2"	27000000000000000000000 1/2"	30000000000000000000000 1/2"	36000000000000000000000 1/2"	42000000000000000000000 1/2"	48000000000000000000000 1/2"	60000000000000000000000 1/2"	72000000000000000000000 1/2"	84000000000000000000000 1/2"	96000000000000000000000 1/2"	108000000000000000000000 1/2"	120000000000000000000000 1/2"	144000000000000000000000 1/2"	168000000000000000000000 1/2"	192000000000000000000000 1/2"	216000000000000000000000 1/2"	240000000000000000000000 1/2"	270000000000000000000000 1/2"	300000000000000000000000 1/2"	360000000000000000000000 1/2"	420000000000000000000000 1/2"	480000000000000000000000 1/2"	600000000000000000000000 1/2"	720000000000000000000000 1/2"	840000000000000000000000 1/2"	960000000000000000000000 1/2"	1080000000000000000000000 1/2"	1200000000000000000000000 1/2"	1440000000000000000000000 1/2"	1680000000000000000000000 1/2"	1920000000000000000000000 1/2"	2160000000000000000000000 1/2"	2400000000000000000000000 1/2"	2700000000000000000000000 1/2"	3000000000000000000000000 1/2"	3600000000000000000000000 1/2"	4200000000000000000000000 1/2"	4800000000000000000000000 1/2"	6000000000000000000000000 1/2"	7200000000000000000000000 1/2"	8400000000000000000000000 1/2"	9600000000000000000000000 1/2"	10800000000000000000000000 1/2"	12000000000000000000000000 1/2"	14400000000000000000000000 1/2"	16800000000000000000000000 1/2"	19200000000000000000000000 1/2"	21600000000000000000000000 1/2"	24000000000000000000000000 1/2"	27000000000000000000000000 1/2"	30000000000000000000000000 1/2"	36000000000000000000000000 1/2"	42000000000000000000000000 1/2"	48000000000000000000000000 1/2"	60000000000000000000000000 1/2"	72000000000000000000000000 1/2"	84000000000000000000000000 1/2"	96000000000000000000000000 1/2"	108000000000000000000000000 1/2"	120000000000000000000000000 1/2"	144000000