

1 PLAN @ PORTE COCHERE
S401 SCALE: 1/4" = 1'-0"

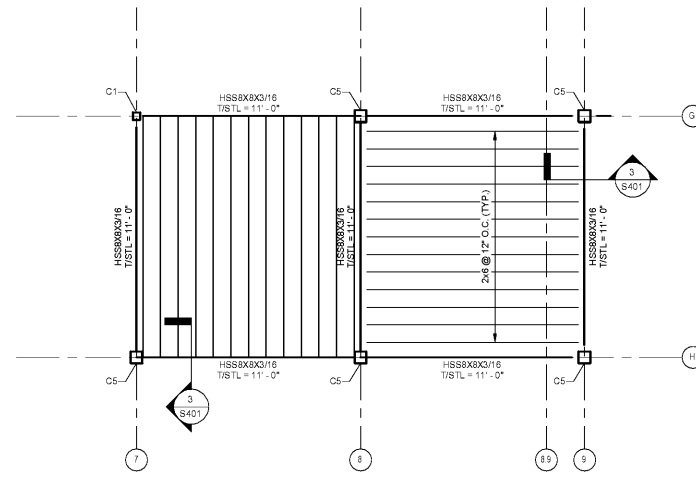

2 PLAN @ TRELLIS
S401 SCALE: 1/4" = 1'-0"

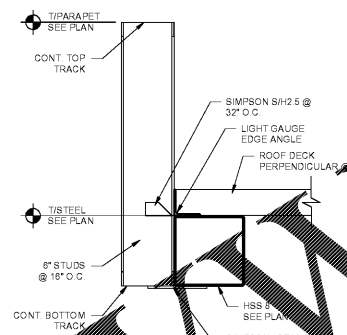

4 PORTE COCHERE PARAPET
S401 SCALE: 1/2" = 1'-0"

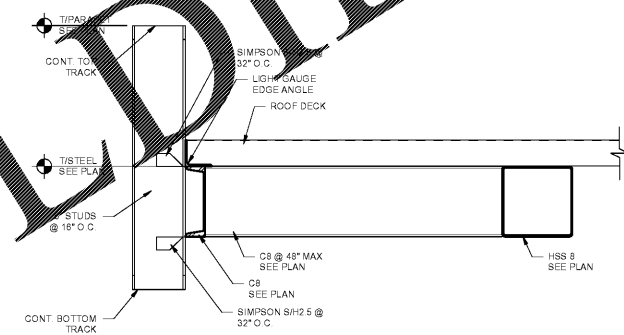

5 PORTE COCHERE LOW PARAPET
S401 SCALE: 1 1/2" = 1'-0"

3 TRELLIS FRAMING TO STEEL BEAM
S401 SCALE: 1 1/2" = 1'-0"

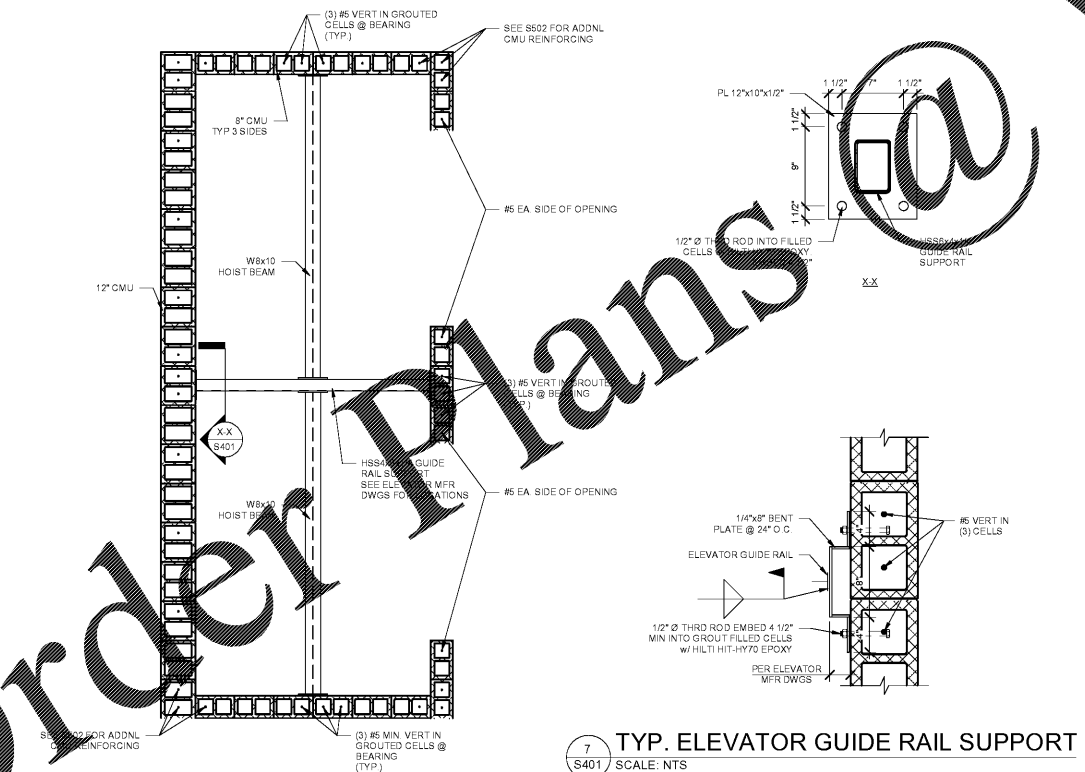
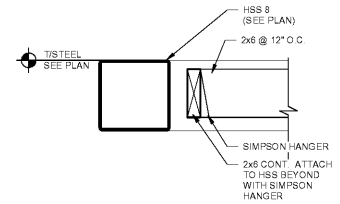

6 PLAN @ ELEVATOR
S401 SCALE: 1/2" = 1'-0"

7 TYP. ELEVATOR GUIDE RAIL SUPPORT
S401 SCALE: INTS

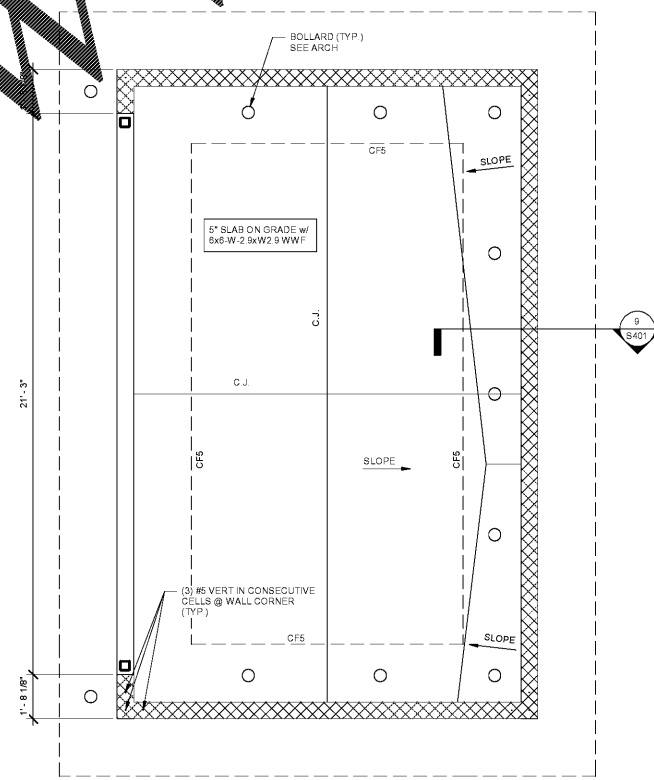

8 DUMPSTER ENCLOSURE
S401 SCALE: 3/8" = 1'-0"

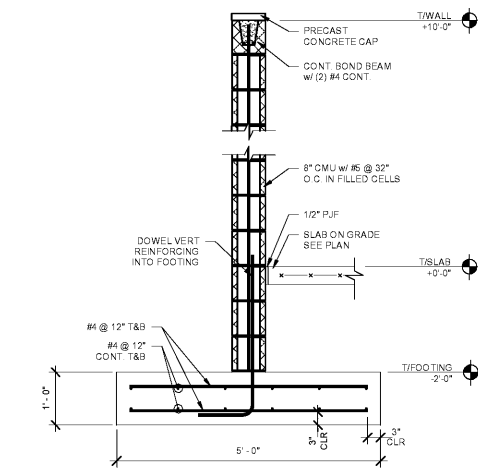

9 DUMPSTER WALL
S401 SCALE: 3/4" = 1'-0"

SHEET ISSUE:
07/30/18
FOR CONSTRUCTION

Number	Revisions	Date