

13 QS / QS-CON / DQS
ID3.13 SCALE: 1/2" = 1'-0"

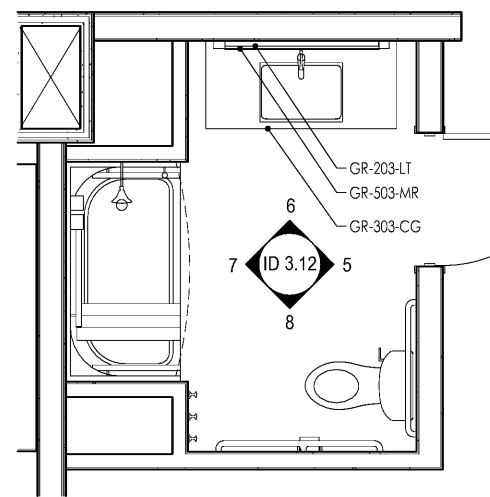

14 QS-ADA / DQS-ADA / DQS-ADA-CON
ID3.13 SCALE: 1/2" = 1'-0"

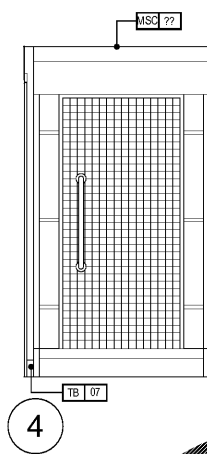
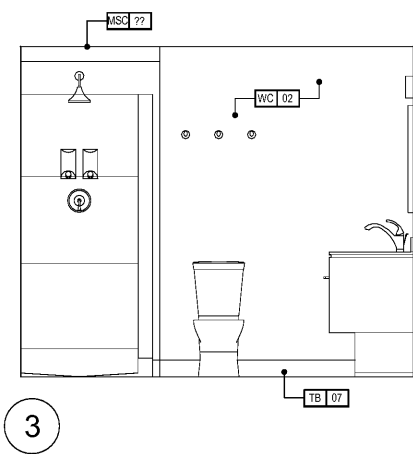
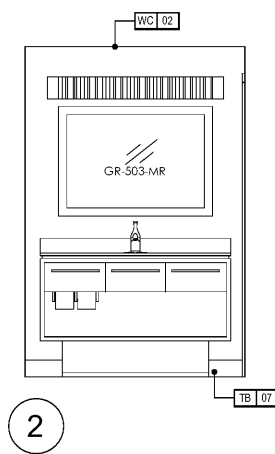
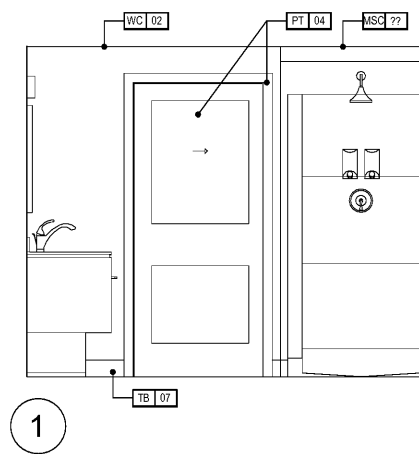
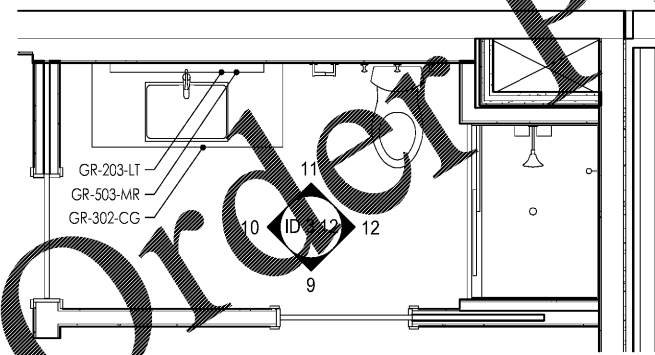
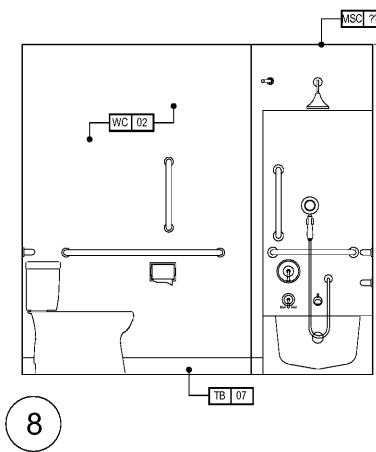
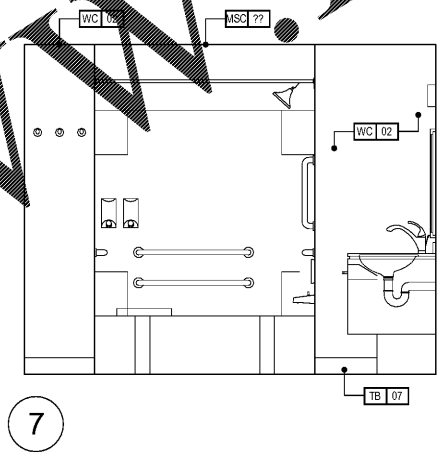
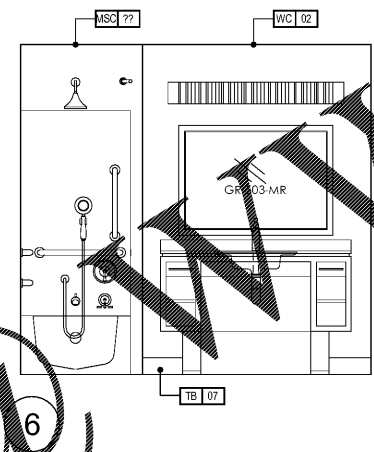
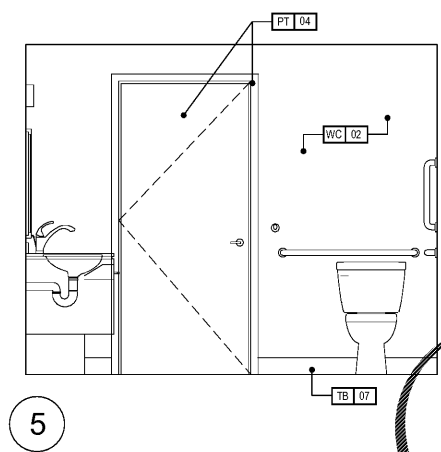

15 K-1B
ID3.13 SCALE: 1/2" = 1'-0"

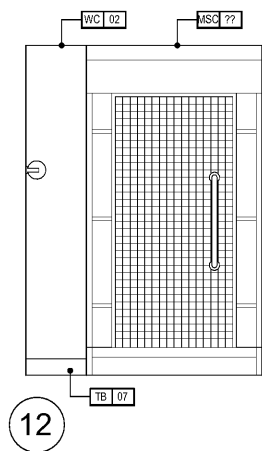
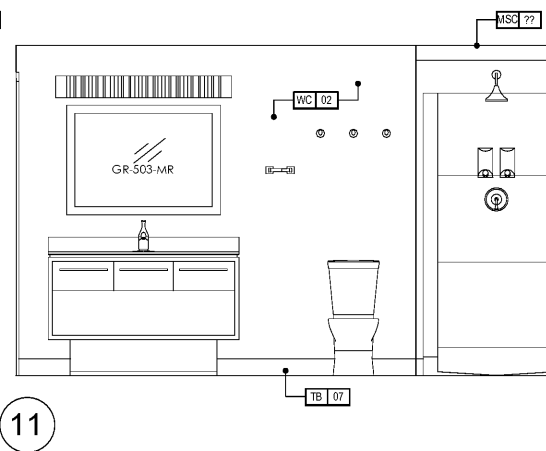
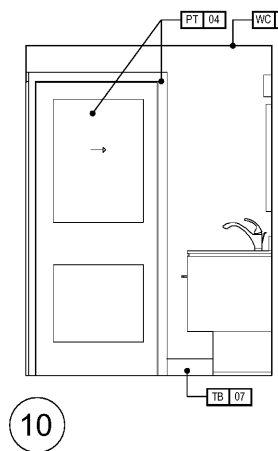
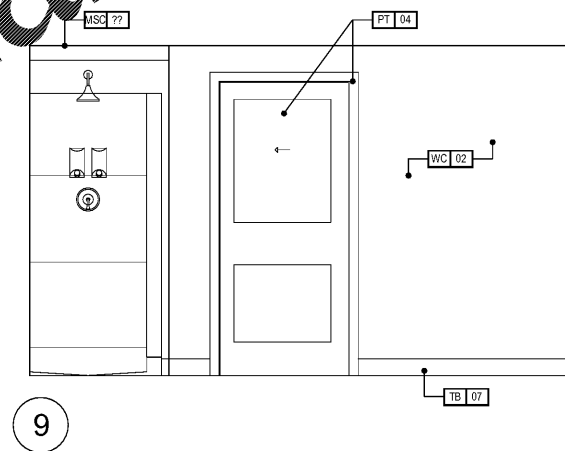

INTERIOR DESIGN DRAWINGS FOR
HOME 2
ASHEVILLE, NC

ISSUED: _____ DATE _____

GUESTROOM
BATHROOM PLANS &
ELEVATIONS
FOR CONSTRUCTION

DATE SET

ID3.13

MEMPHIS OFFICE
7975 Stage Hills
Boulevard, Suite 11
Memphis TN 38133
NASHVILLE OFFICE
9000 Split Log Road
Brentwood TN 37027
P: 901.384.8536
F: 666.860.8790

AKDGD
AK DESIGN GROUP, LLC
HOSPITALITY INTERIORS

Order Plans @

WWW.LDILine.com