

City of Asheville, NC
Standard Specifications and Details Manual

STANDARD CONCRETE CURB AND GUTTER

DATE: _____ REVISIONS: _____ STD. NO.: **3.11**

A1 STANDARD CONCRETE CURB & GUTTER N.T.S.

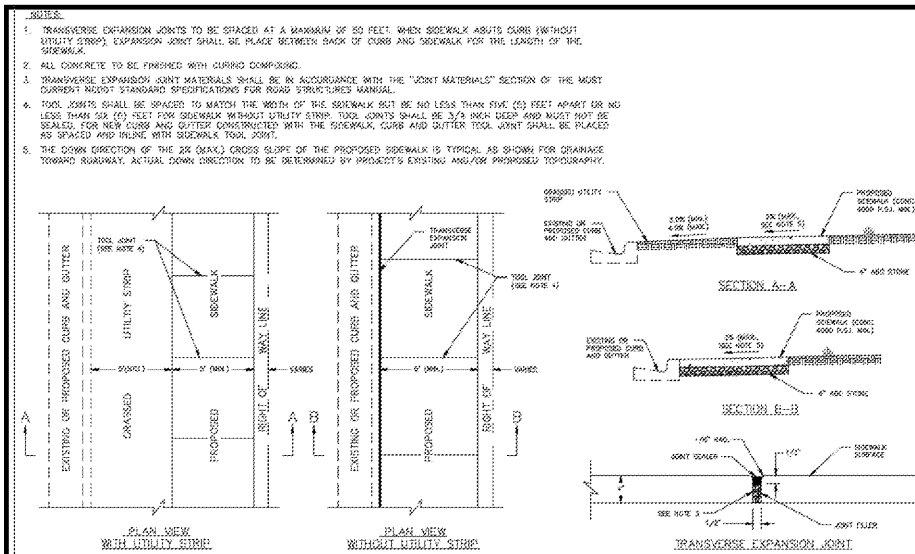

City of Asheville, NC
Standard Specifications and Details Manual

STANDARD CONCRETE SIDEWALK

DATE: _____ REVISIONS: _____ STD. NO.: **3.16**

B1 STANDARD CONCRETE SIDEWALK N.T.S.

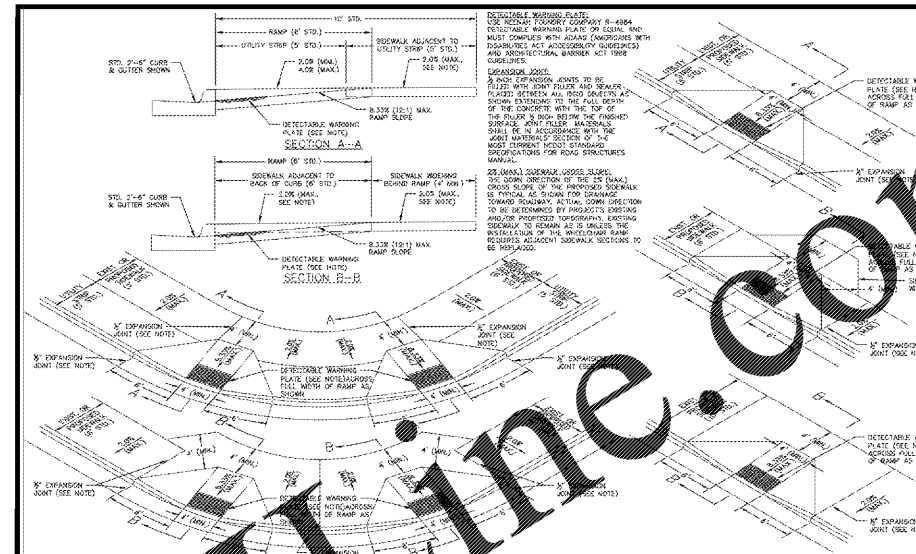

City of Asheville, NC
Standard Specifications and Details Manual

STANDARD WHEELCHAIR RAMP

DATE: _____ REVISIONS: _____ STD. NO.: **3.17**

C1 STANDARD WHEELCHAIR RAMP N.T.S.

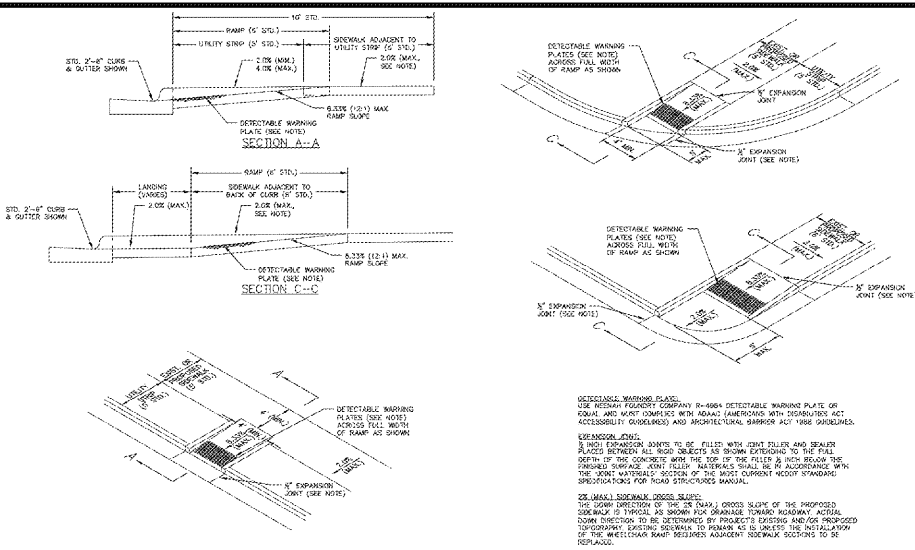

City of Asheville, NC
Standard Specifications and Details Manual

STANDARD WHEELCHAIR RAMP

DATE: _____ REVISIONS: _____ STD. NO.: **3.17A**

A2 STANDARD WHEELCHAIR RAMP N.T.S.

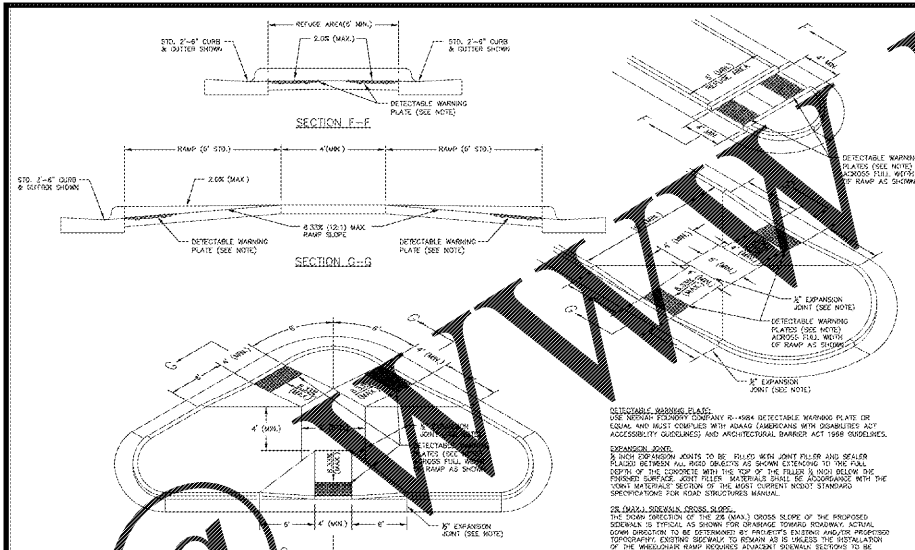

City of Asheville, NC
Standard Specifications and Details Manual

STANDARD WHEELCHAIR RAMP

DATE: _____ REVISIONS: _____ STD. NO.: **3.17C**

B2 STANDARD WHEELCHAIR RAMP N.T.S.

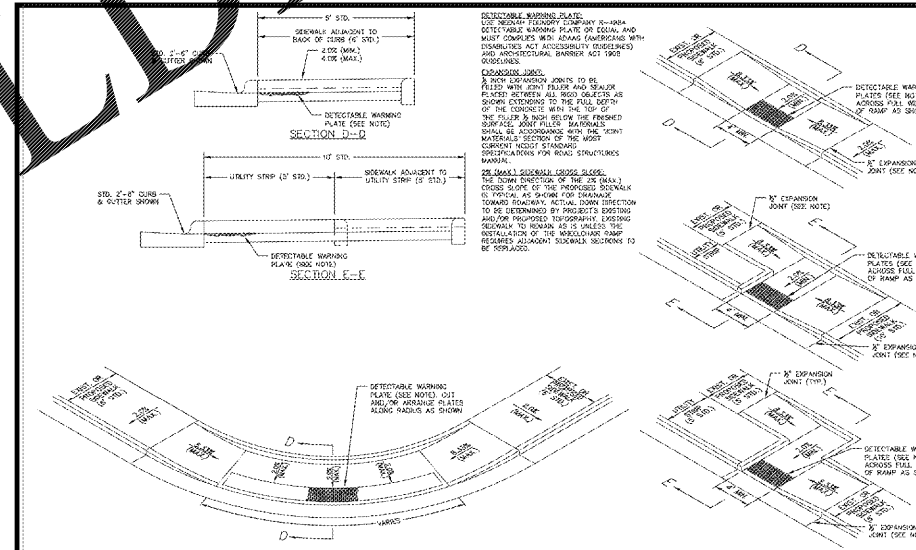

City of Asheville, NC
Standard Specifications and Details Manual

STANDARD WHEELCHAIR RAMP

DATE: _____ REVISIONS: _____ STD. NO.: **3.17B**

C2 STANDARD WHEELCHAIR RAMP N.T.S.

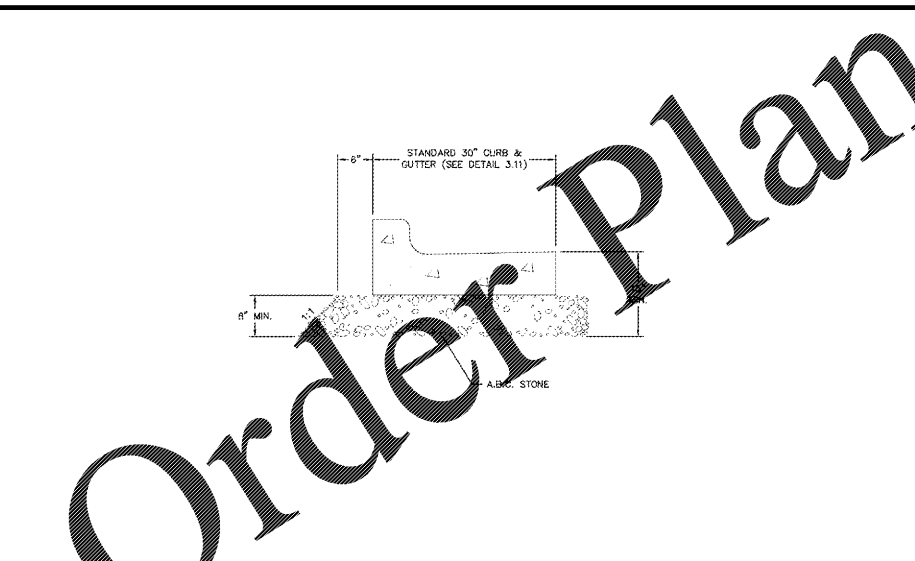

City of Asheville, NC
Standard Specifications and Details Manual

A.B.C. UNDER 2'-6" CURB & GUTTER

DATE: _____ REVISIONS: _____ STD. NO.: **3.10**

A3 A.B.C. UNDER 2'-6" CURB & GUTTER N.T.S.

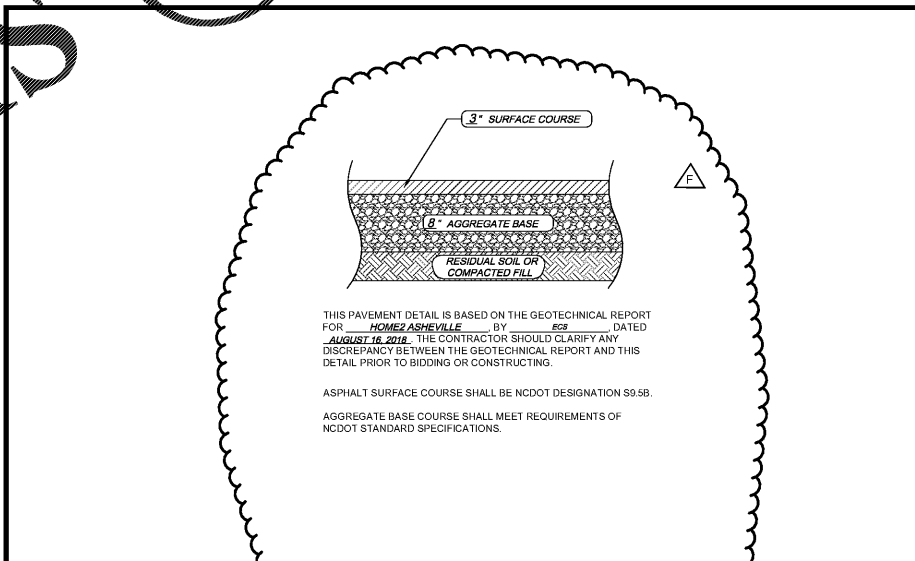

HEAVY DUTY ASPHALT PAVING SPECIFICATION

DATE: _____ REVISIONS: _____ STD. NO.: _____

B3 HEAVY DUTY ASPHALT PAVING SPECIFICATION N.T.S.

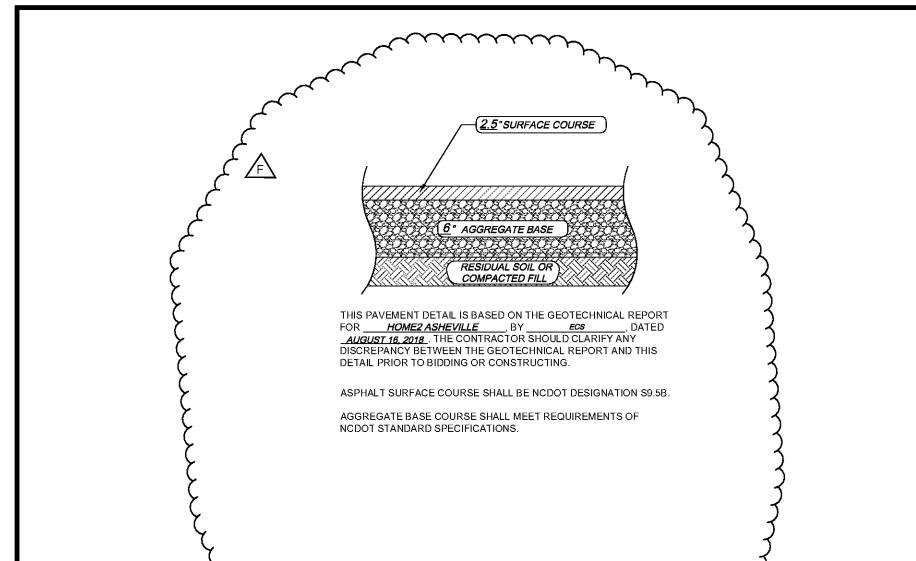

LIGHT DUTY ASPHALT PAVING SPECIFICATION

DATE: _____ REVISIONS: _____ STD. NO.: _____

C3 LIGHT DUTY ASPHALT PAVING SPECIFICATION N.T.S.

NO. DATE CITY COUNCIL DIVISION

A 08/09/18 SITE DESIGN MODIFICATION

B 08/09/18 CITY COUNCIL DIVISION

C 08/22/18 REV PER HILTON AD UTILITY WASTE SYSTEM

D 08/20/18 REV PER COMMENTS FROM ARCHITECT

E 09/14/18 FINAL TRC SUBMITTAL

F 09/27/18 ADDENDUM C

CAPIOLA HILTON ENGINEERS, PLLC
CCAL, PLLC
N.E. P-10689
08/27/18
CERTIFIED TRUE AND CORRECT
CORPORATE SEAL

CCAD ENGINEERING
Greenwood | Charleston
803 Poplar Creek Drive
864-250-9999 | E: 864-250-0556
www.ccadengineering.com

PROJECT: Airport Road Hotel
Site Development Plans
Arden, North Carolina

SHEET TITLE: **SITE DETAILS**

DATE: 01/08/2018 THE INFORMATION ON THIS SHEET IS COMPRISED OF THE INFORMATION PROVIDED TO THE ARCHITECT BY THE CLIENT. THE ARCHITECT HAS REVIEWED THE INFORMATION AND HAS FOUND IT TO BE ACCURATE AND COMPLETE. THE ARCHITECT'S REVIEW IS LIMITED TO THE INFORMATION PROVIDED AND DOES NOT CONSTITUTE A GUARANTEE OF THE ACCURACY OF THE INFORMATION OR THE RESULTS OF ANY DESIGN OR CONSTRUCTION BASED THEREON. THE ARCHITECT'S LIABILITY IS LIMITED TO THE DESIGN AND CONSTRUCTION OF THE PROJECT AND DOES NOT EXTEND TO ANY OTHER MATTER. THE ARCHITECT'S LIABILITY IS LIMITED TO THE DESIGN AND CONSTRUCTION OF THE PROJECT AND DOES NOT EXTEND TO ANY OTHER MATTER.

SCALE: N.T.S.

DRAWN: CCAD

CHECKED: WBC

PROJECT #: C03082E

DATE: 01/08/2018

SCALE: N.T.S.

DRAWN: CCAD

CHECKED: WBC

PROJECT #: C03082E

DATE: 01/08/2018

SCALE: N.T.S.

DRAWN: CCAD

CHECKED: WBC

PROJECT #: C03082E