

1. ACCESSIBLE ROUTE:
 A. AN ACCESSIBLE ROUTE SHALL BE PROVIDED FROM PUBLIC STREETS, SIDEWALKS AND PUBLIC TRANSPORTATION STOPS TO THE ACCESSIBLE ENTRANCE.

2. WALKS AND SIDEWALKS:
 A. WALKS AND SIDEWALKS SHALL HAVE A CONTINUOUS COMMON SURFACE NOT INTERRUPTED BY STEPS OR BY ABRUPT CHANGES IN LEVEL EXCEEDING 1/4 INCH (PER 303 OF ADA 2010) AND SHALL BE A MINIMUM OF 3 FEET IN WIDTH.
 B. WALKING SURFACE SLOPE SHALL NOT EXCEED 1:20. CROSS SLOPES SHALL NOT EXCEED 1:48 (PER 403.3 OF ADA 2010).
 C. WALKS, SIDEWALKS AND PEDESTRIAN WAYS SHALL BE FREE OF GRATING WHENEVER POSSIBLE. FOR GRATINGS LOCATED IN THE SURFACE OF ANY OF THESE AREAS, GRID OPENINGS IN GRATINGS SHALL NOT ALLOW PASSAGE OF A 1/2 INCH SPHERE.
 D. WHEN THE SLOPE IN THE DIRECTION OF TRAVEL OF ANY WALK EXCEEDS 1 VERTICAL TO 20 HORIZONTAL IT SHALL COMPLY WITH THE PROVISIONS FOR PEDESTRIAN RAMPS.
 E. VERTICAL CHANGES IN LEVEL ALONG ANY ACCESSIBLE ROUTE SHALL NOT EXCEED 1/4 INCH. WHEN UP TO 1/2 INCH CHANGES IN LEVEL OCCUR, THEY SHALL BE BEVELED WITH A SLOPE NO GREATER THAN 1:2. WHEN CHANGES IN LEVEL GREATER THAN 1/2 INCH ARE NECESSARY THEY SHALL COMPLY WITH THE REQUIREMENTS FOR CURB RAMPS (PER 403 AND 406 OF ADA 2010).
 F. WALKS SHALL BE PROVIDED WITH A LEVEL AREA CONSISTENT WITH MANEUVERING CLEARANCES AT MANUAL SWING DOORS AND GATES (PER 404.2.4.1 OF ADA 2010).
 G. ALL WALKS WITH CONTINUOUS GRADIENTS SHALL HAVE LEVEL AREAS OF AT LEAST 5 FEET IN LENGTH AT INTERVALS OF AT LEAST EVERY 200 FEET (PER 403.5.3 OF ADA 2010).

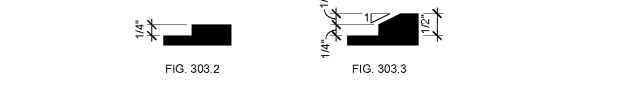

3. CURB RAMPS:
 A. CURB RAMPS SHALL HAVE A MAXIMUM SLOPE OF 1:12 WITH A MAXIMUM CROSS SLOPE OF 1:48. THE CLEAR WIDTH SHALL BE A MINIMUM OF 36 INCHES WIDE. THE FLARED SIDE SHALL HAVE A MAXIMUM SLOPE OF 1:10.
 B. THE MINIMUM LANDING AT THE TOP OF A CURB RAMPS SHALL BE 36 INCHES WIDE (PER FIGURE 406.4 OF ADA 2010).

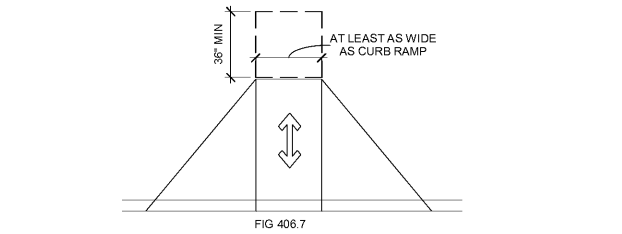

4. ACCESSIBLE PARKING:
 A. ACCESSIBLE PARKING SPACES SHALL BE LOCATED ON THE SHORTEST ACCESSIBLE ROUTE FROM PARKING TO AN ACCESSIBLE ENTRANCE.
 B. ACCESSIBLE PARKING SPACES SHALL HAVE A MINIMUM WIDTH OF 96 INCHES FOR CAR AND 132 FOR VAN (PER 502.2 ADA 2010).
 C. 60 INCH WIDE ACCESS AISLES SHALL BE PROVIDED. TWO PARKING SPACES SHALL BE PERMITTED TO SHARE A COMMON ACCESS AISLE. ACCESS AISLES SLOPES SHALL NOT EXCEED 1:48 IN ANY DIRECTION.
 D. WHERE PARKING RESULTS IN VEHICLES OVER HANGING INTO WALKWAYS, SIDEWALKS OR OTHER ACCESSIBLE ROUTES, THE OVERHANG SHALL NOT ENCRUSH ON THE REQUIRED CLEAR WIDTH OF THE TRAVEL PATH.
 E. ACCESSIBLE PARKING SPACES AND ACCESS AISLES SHALL BE MEASURED TO THE CENTERLINE OF THE PARKING STRIPE DESIGNATING THE SPACE. ACCESS PARKING SPACES SHALL BE OUTLINED IN BLUE PAINT; THE OUTLINED BLUE PAINT SHALL BE MARKED INSIDE THE SPACES' STRIPING FOR ITS SIZE.
 F. ACCESSIBLE PARKING SIGNS SHALL INCLUDE THE INTERNATIONAL SYMBOL FOR ACCESSIBILITY (ISA) COMPLYING WITH 703.2.1 OF ADA 2010. SIGNS SHALL BE MOUNTED 60 INCHES MINIMUM ABOVE THE GROUND OR FLOOR SURFACE MEASURED TO THE BOTTOM OF THE SIGN (PER 502.6 OF ADA 2010).
 G. A SIGN INDICATING THE PENALTY FOR ILLEGAL USE SHALL BE POSTED BELOW THE ACCESSIBILITY PARKING SIGN.

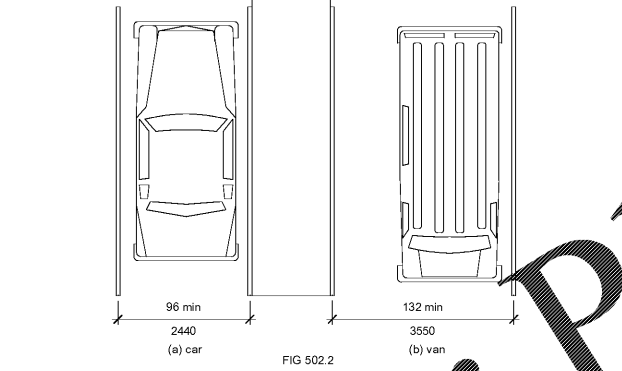

5. RAMPS:
 A. ANY PATH OF TRAVEL SHALL BE CONSIDERED A RAMP IF THE SLOPE IS GREATER THAN 1:20 (1:12 MAXIMUM FOR RAMPS).
 B. RAMPS WITH A VERTICAL RISE GREATER THAN 6 INCHES SHALL HAVE HANDRAILS ON BOTH SIDES.
 C. THE TOP LANDINGS ON A RAMP MUST BE AT LEAST 48 INCHES IN DEPTH.
 D. IF A DOOR SWINGS ONTO A TOP LANDING, THE MINIMUM LANDING DIMENSIONS SHALL MEET THE MANEUVERING CLEARANCES AT MANUAL SWING DOORS AND GATES (PER FIGURE 404.2.4.1 OF ADA 2010).
 E. THE BOTTOM LANDING SHALL BE AT LEAST 75 INCHES DEEP.
 F. INTERMEDIATE LANDINGS SHALL BE PROVIDED AT TURN AND WHENEVER THE CHANGE IN INTERMEDIATE SLOPES.
 G. INTERMEDIATE LANDING ON STRAIGHT RAMPS SHALL HAVE A DEPTH OF NOT LESS THAN 60 INCHES. INTERMEDIATE LANDINGS ON RAMPS THAT TURN GREATER THAN 30 DEGREES SHALL NOT BE LESS THAN 72 INCHES IN DEPTH.
 H. RAMPS SHALL NOT BE LESS THAN 36 INCHES WIDE.
 I. HANDRAILS SHALL BE PLACED ON EACH SIDE OF EACH RAMP AND SHALL BE CONTINUOUS THE FULL LENGTH OF THE RAMP. HANDRAILS SHALL BE 34 TO 38 INCHES ABOVE THE RAMP SURFACE AND EXTEND A MINIMUM OF 1 FOOT BEYOND THE TOP AND BOTTOM OF THE RAMP.

1. HANDRAILS SHALL PROVIDE EDGE PROTECTION FOR RAMPS.
 a. RAMPS SHALL HAVE EDGE PROTECTION (PER 405.9 OF ADA 2010) ON EACH SIDE OF RAMP RUN AND EACH SIDE OF RAMP.
 i. 405.9.1 THE FLOOR OR GROUND SURFACE SHALL EXTEND 12 INCHES BEYOND THE INSIDE FACE OF THE HANDRAIL.
 ii. 405.9.2 A CURB OR BARRIER SHALL BE PROVIDED THAT PREVENTS THE PASSAGE OF A 4 INCH DIAMETER SPHERE. WHERE ANY PORTION OF THE SPHERE IS WITHIN 4 INCHES OF THE FINISHED FLOOR OR GROUND.
 J. SURFACES OF RAMPS SHALL BE SLIP-RESISTANT.

6. SIGNS:
 A. SIGNS SHALL COMPLY WITH 703 OF ADA 2010.
 B. WHEN SIGNS IDENTIFY PERMANENT ROOMS AND SPACES OF A BUILDING OR SITE, THEY SHALL COMPLY WITH SECTIONS BELOW.
 C. WHEN SIGNS IDENTIFY, DIRECT OR GIVE INFORMATION ABOUT ACCESSIBLE ELEMENTS AND FEATURES, THEY SHALL COMPLY WITH SECTIONS 1 THRU 6.

1. FINISH AND CONTRAST: CHARACTERS, SYMBOLS, PICTOGRAMS AND THEIR BACKGROUND SHALL HAVE A NON-GLARE FINISH. CHARACTERS, SYMBOLS AND PICTOGRAMS SHALL CONTRAST WITH THEIR FIELD, EITHER LIGHT ON DARK BACKGROUND OR DARK ON LIGHT BACKGROUND.
 2. PROPORTIONS: CHARACTERS ON SIGNS SHALL BE SELECTED FROM FONTS WHERE THE WIDTH OF THE UPPERCASE LETTER "O" IS 55 PERCENT MINIMUM AND 110 PERCENT MAXIMUM OF THE HEIGHT OF THE UPPERCASE LETTER "I".
 3. RAISED CHARACTERS AND PICTORIAL SYMBOL SIGNS:
 a. CHARACTER TYPE: CHARACTER ON SIGNS SHALL BE RAISED 1/32 INCH (0.794mm) MINIMUM AND SHALL BE SANS SERIF UPPERCASE CHARACTERS ACCOMPANIED BY GRADE 2 BRAILLE. (SEE ITEM 4 BELOW.)
 b. CHARACTER SIZE: RAISED CHARACTERS SHALL BE A MINIMUM OF 5/8 INCH (15.9mm) AND A MAXIMUM OF 2 INCHES (51mm) HIGH.
 c. PICTORIAL SYMBOLS (PICTOGRAMS): THE OUTSIDE DIMENSION OF THE PICTOGRAM FIELD SHALL BE A MINIMUM OF 6 INCHES (152mm) IN HEIGHT.
 d. TEXT DESCRIPTORS: PICTORIAL SYMBOL SIGNS (PICTOGRAMS) SHALL BE ACCOMPANIED BY TEXT DESCRIPTORS LOCATED DIRECTLY BELOW THE PICTOGRAM FIELD. TEXT DESCRIPTORS SHALL COMPLY WITH 703.2, 703.3 AND 703.4 OF ADA 2010.
 e. CHARACTER PLACEMENT: CHARACTERS AND BRAILLE SHALL BE IN HORIZONTAL FORMAT. BRAILLE SHALL BE PLACED A MINIMUM OF 3/8 INCH DIRECTLY BELOW THE TACTILE CHARACTERS, FLUSH LEFT OR CENTERED. WHEN TACTILE TEXT IS MULTI-LINED, ALL BRAILLE SHALL BE PLACED TOGETHER BELOW ALL LINES OF TACTILE TEXT.
 f. SYMBOLS OF ACCESSIBILITY: SYMBOLS OF ACCESSIBILITY SHALL COMPLY WITH 703.7 ADA 2010.
 4. BRAILLE: CONTRACTED GRADE 2 BRAILLE SHALL BE USED WHEREVER BRAILLE IS REQUIRED IN OTHER PORTIONS OF THESE STANDARDS. DOTS SHALL BE .09-1 INCH IN EACH CELL WITH .24-.3 INCH SPACE BETWEEN CELLS, MEASURED CENTER TO CENTER FROM THE FIRST COLUMN OF DOTS IN THE FIRST CELL TO THE FIRST COLUMN OF DOTS IN THE SECOND CELL. DOTS SHALL BE .025-.037 INCHES ABOVE THE BACKGROUND. BRAILLE DOTS SHALL BE DOMED OR ROUNDED (PER 703.3.1 OF ADA 2010).
 5. MOUNTING LOCATION AND HEIGHT: WHERE PERMANENT IDENTIFICATION IS PROVIDED FOR ROOMS AND SPACES, SIGNS SHALL BE INSTALLED ON THE WALL ADJACENT TO THE LATCH SIDE OF THE DOOR. WHERE THERE IS NO WALL SPACE ON THE LATCH SIDE, INCLUDING A DOOR, SIGNS SHALL BE PLACED ON THE WALL ADJACENT TO THE HINGE SIDE, PREFERABLY ON THE RIGHT. TACTILE CHARACTERS SHALL BE LOCATED 48 INCHES MINIMUM ABOVE THE FINISHED FLOOR OR GROUND SURFACE, MEASURED FROM THE BASELINE OF THE HIGHEST TACTILE CHARACTER (PER 703.4.1 ADA 2010).
 6. SIGNS CONTAINING TACTILE CHARACTERS SHALL BE LOCATED SO THAT A CLEAR FLOOR SPACE 18 INCH MIN. X 18 INCH MIN. CENTERED ON THE TACTILE LETTERS IS PROVIDED BEYOND THE ARC OF THE DOOR SWINGS BETWEEN THE CLOSED POSITION AND 45 DEGREES OPEN POSITION (PER 703.4.2 ADA 2010).

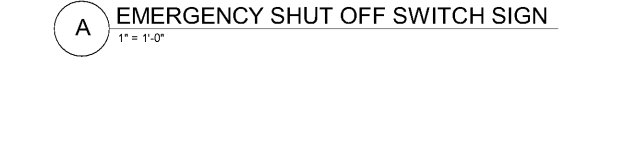
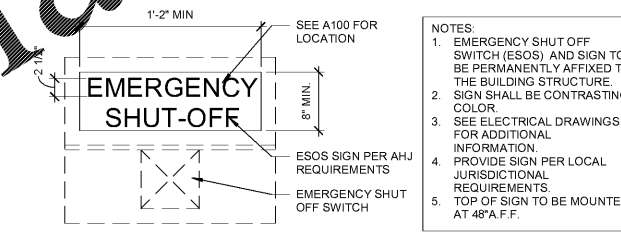
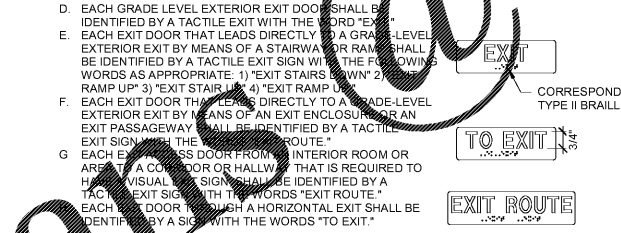
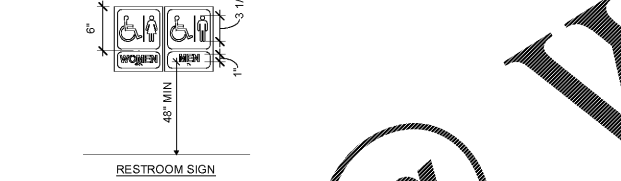
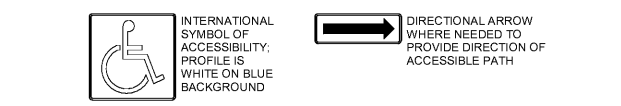

7. DOORS:
 A. LATCHES AND LOCKSETS: PROVIDE LEVER TYPE, PUSH-PULL OR PANIC TYPE HARDWARE 34 INCHES TO 48 INCHES ABOVE FLOOR.
 B. MAXIMUM FORCE TO OPERATE INTERIOR / NON-FIRE RATED DOORS SHALL BE 5 LBS PRESSURE. COORDINATE FIRE DOORS OPENING FORCE WITH LOCAL CODES.
 C. THRESHOLDS: THE FLOOR OR LANDING SHALL NOT BE MORE THAN 1/2 INCH LOWER THAN THE THRESHOLD OF THE DOORWAY. CHANGE IN LEVEL BETWEEN 1/4 INCH AND 1/2 INCH SHALL BE BEVELED WITH A SLOPE NO GREATER THAN 1:2 (PER FIGURE 303.3 OF ADA 2010).
 D. LEVEL FLOOR LANDING: THERE SHALL BE A LEVEL SURFACE NOT STEEPER THAN 1:48 AND CLEAR AREA ON EACH SIDE OF AN EXIT DOOR. THE LEVEL AREA SHALL BE AS SHOWN IN FIGURE 404.2.4.1 OF ADA 2010. THE SPACE BETWEEN TWO CONSECUTIVE DOOR OPENINGS (VESTIBULE) SHALL PROVIDE 48 INCHES OF CLEAR SPACE FROM ANY OPENED DOOR INTO SUCH SPACE.
 E. DOOR WIDTH AND HEIGHT: 3 FEET WIDE AND 6 FEET 8 INCHES HIGH. CLEAR WIDTH: 32 INCHES MINIMUM WITH DOOR OPEN 90 DEGREES MEASURED FROM THE FACE OF THE DOOR TO THE OPPOSITE STOP. THE BOTTOM 10 INCHES OF ALL DOORS EXCEPT AUTOMATIC AND SLIDING SHALL HAVE A SMOOTH UNINTERRUPTED SURFACE TO ALLOW THE DOOR TO BE OPENED BY A WHEELCHAIR FOOTREST WITHOUT CREATING A TRAP OR HAZARDOUS CONDITION.

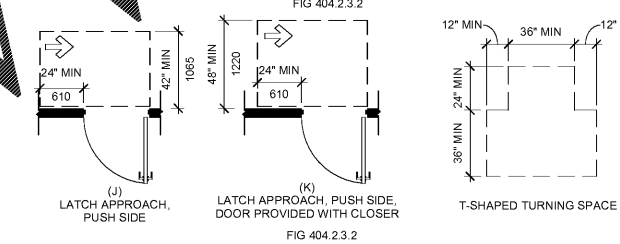
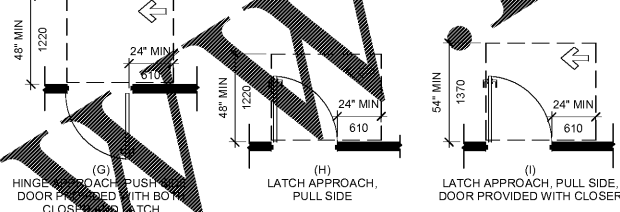
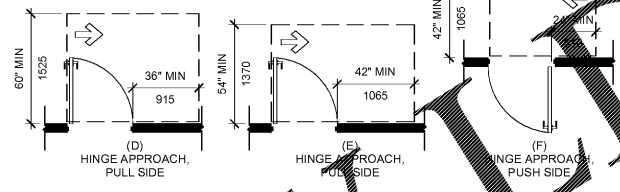
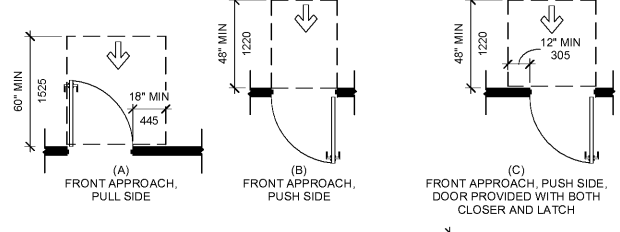

8. SALES/SELF SERVICE AREAS:
 A. FOOD SERVICE AREAS SHOULD BE INSTALLED TO ALLOW AT LEAST 50% OF THE SELF SERVICE SHELVES TO BE WITHIN THE REACH RANGES OF 15 INCH LOW AND 48 INCH HIGH PER 2010 STANDARDS, SECTION 904.5.1.
 B. ALL ACCESSIBLE ROUTES SHALL HAVE A MINIMUM CLEAR WIDTH OF 36 INCHES WITH A 60 INCH CLEAR DEPTH OR CLEAR WIDTH OF 42 INCHES WITH A 48 INCH CLEAR DEPTH AT U-TURNS PER ACCESSIBILITY STANDARDS.

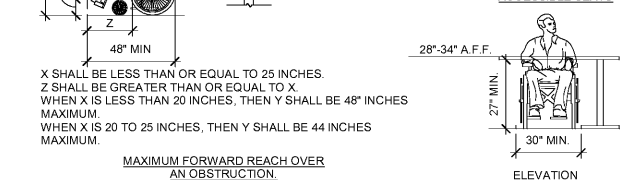
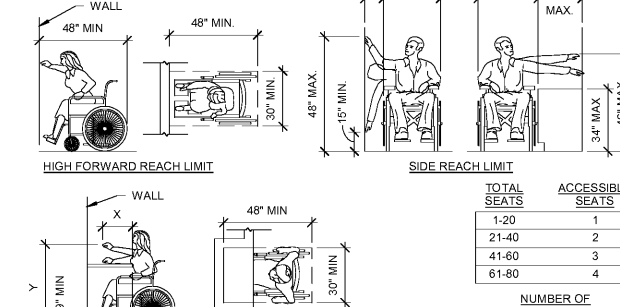

9. PROTRUDING OBJECTS:
 A. PROJECTIONS FROM WALLS WITH LEADING EDGE BETWEEN 27 INCHES AND 80 INCHES ABOVE FLOOR MAY PROJECT 4 INCHES MAXIMUM. LEADING EDGE AT OR BELOW 27 INCHES SHALL PROJECT ANY AMOUNT. FREE STANDING OBJECTS MOUNTED ON POSTS OR PYLONS SHALL OVERHANG CIRCULATION PATHS 2 INCHES MAX. WHEN LOCATED 27 INCHES MIN AND 80 INCHES MAXIMUM ABOVE THE FLOOR OR GROUND SURFACE (PER 307.3 OF ADA 2010), PROJECTIONS MAY NOT REDUCE MANEUVERING SPACE, OR CLEAR WIDTH OF AN ACCESSIBLE ROUTE.
 B. HEAD ROOM: 80 INCHES MINIMUM.

10. SANITARY FACILITIES:
 A. ACCESSIBLE COMPARTMENT DOORS SHALL BE SELF CLOSING. THE INSIDE AND OUTSIDE OF THE COMPARTMENT DOOR SHALL BE EQUIPPED WITH A DOOR PULL IMMEDIATELY BELOW THE LATCH. THE LATCH SHALL NOT REQUIRE THE USER TO GRASP OR TWIST.
 B. WATER CLOSET: THE HANDLE OR BUTTON IS TO BE LOCATED ON THE WIDE SIDE OF THE WATER CLOSET.
 C. URINALS: PROVIDE WALL HUNG URINALS OR STALL TYPE WITH RIM ELEVATED 17 INCHES MAXIMUM A.F.F. AND RIM PROJECTING 13-1/2" MINIMUM.
 D. LAVATORY: PROVIDE CLEARANCE OF AT LEAST 27 INCHES FROM THE FLOOR TO THE BOTTOM OF THE APRON AND SINK RIM OR COUNTER SURFACE 36" MAXIMUM, WITH A MAXIMUM OF 2 INCHES CLEARANCE UNDER THE FRONT UP EXTENDING A MINIMUM CLEARANCE OF 30 INCHES WIDE, TO 9 INCHES ABOVE THE FLOOR AND 17 INCHES DEEP FROM THE FRONT OF THE LAVATORY. PROVIDE A CLEAR FLOOR SPACE 30"x48" IN FRONT OF LAVATORY. THE CLEAR SPACE MAY EXTEND INTO KNEE AND TOE SPACE UNDERNEATH THE LAVATORY. ILLUMINATE HOT WATER AND DRAIN PIPES UNDER LAVATORIES. PROJECT CONTROLS ARE REQUIRED TO BE OPERABLE WITH ONE HAND AND CANNOT REQUIRE GRASPING OR TWISTING OF THE WRIST. THE FORCE NECESSARY TO OPERATE CONTROLS SHALL NOT EXCEED 5 LBS.F.
 E. ACCESSORIES: WHERE THE SANITARY NAPKIN DISPOSAL, WASTE RECEPTACLES AND SIMILAR DISPENSING AND DISPOSAL DEVICES ARE PROVIDED, AT LEAST ONE OF EACH TYPE IS TO BE PROVIDED WITH ALL OPERABLE PARTS, INCLUDING COIN SLOTS, WITHIN 40 INCHES FROM THE FRONT OF THE BUILDING.
 F. MOUNT MIRRORS WITH THE REFLECTIVE EDGE NOT MORE THAN 40 INCHES ABOVE THE FLOOR.
 G. LOCATE TOILET TISSUE DISPENSERS ON THE WALL WITHIN 7-9" FROM THE FRONT EDGE OF THE TOILET SEAT BETWEEN 15" AND 48" FROM THE FLOOR TO THE PAPER OUTLET.
 H. THE STRUCTURAL STRENGTH OF GRAB BARS, FASTENERS, AND MOUNTING DEVICES SHALL MEET THE BUILDING CODE.

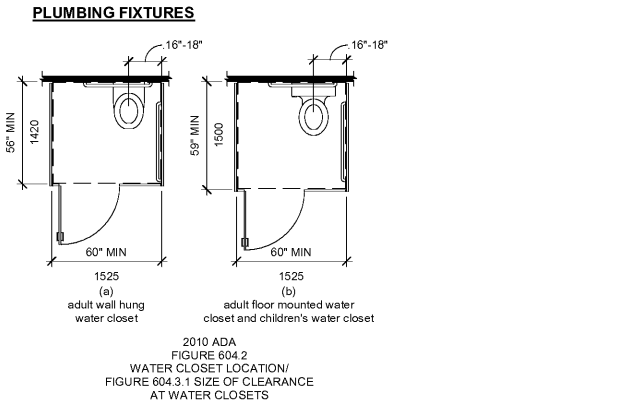
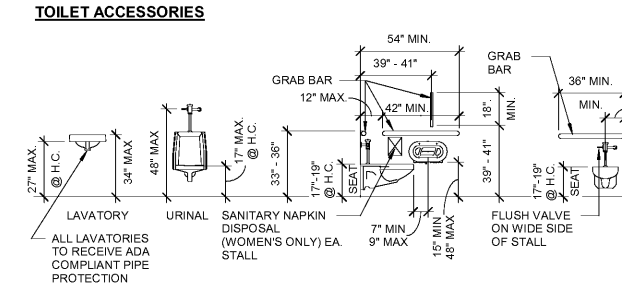
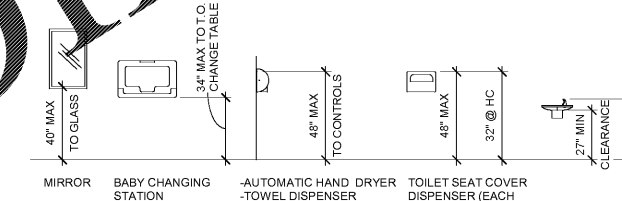

11. ELECTRICAL:
 A. ELECTRICAL RECEPTACLES (15, 20 AND 30 AMPS) SHALL BE AT LEAST 15 INCHES ABOVE THE FLOOR.
 B. THE OPERATIONAL PORTION OF SWITCHES AND CONTROLS FOR LIGHTS, APPLIANCES, COOLING, HEATING AND VENTILATING EQUIPMENT SHALL BE NOT LESS THAN 36 INCHES NOR MORE THAN 48 INCHES ABOVE THE FLOOR.
 C. FIRE ALARM INITIATING DEVICES SHALL BE 48 INCHES ABOVE THE FLOOR, GROUND, OR SIDEWALK. FLUSH VALVE HEIGHT SHALL BE 48 INCHES MAX.

