

**general notes**

- A. REFER TO CIVIL DRAWINGS FOR SCOPE OF WORK FOR SITE IMPROVEMENTS
- B. REFER TO EXTERIOR ELEVATIONS FOR ADDITIONAL INFORMATION ON BUILDING ELEMENTS
- C. REFER TO FINISH SCHEDULE FOR MATERIAL INFORMATION

**symbol legend**

- NEW PARTITION
- NEW DOOR
- KEYNOTE
- CONCRETE
- ALIGN

architect + engineer



project no. | KRKNS0002

owner

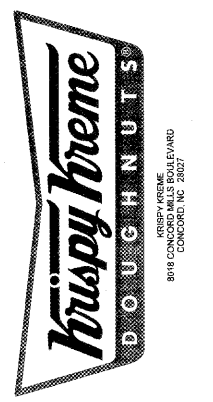

project info

CONCORD NORTH CAROLINA

issue dates

submission:	Date
OWNER/LL REVIEW	11/01/2018
BID SET	11/01/2018
PERMIT SET	11/01/2018

revisions:

#	Description	Date
---	-------------	------

seal



sheet info

DUMPSTER ENCLOSURE  
**AS101**

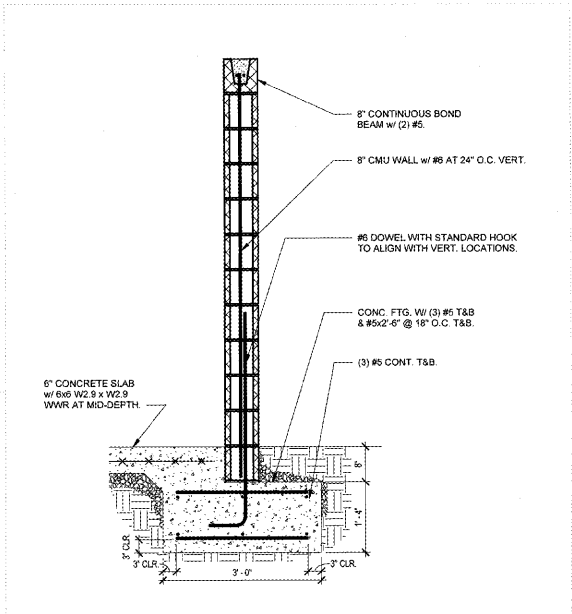

**08 trash enclosure wall**  
SCALE | 3/4" = 1'-0"

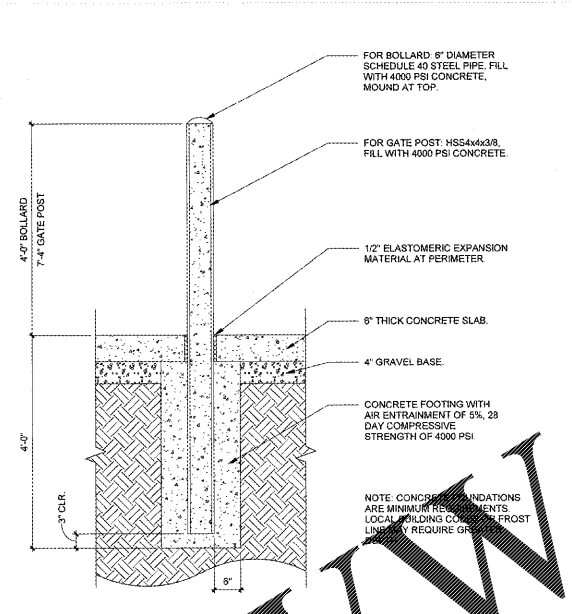

**09 bollard/gate post detail**  
SCALE | 3/4" = 1'-0"

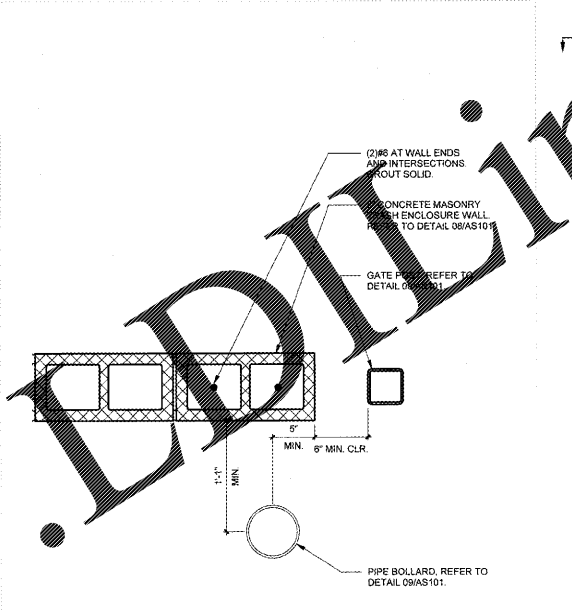

**10 enlarged trash enclosure plan**  
SCALE | 1 1/2" = 1'-0"

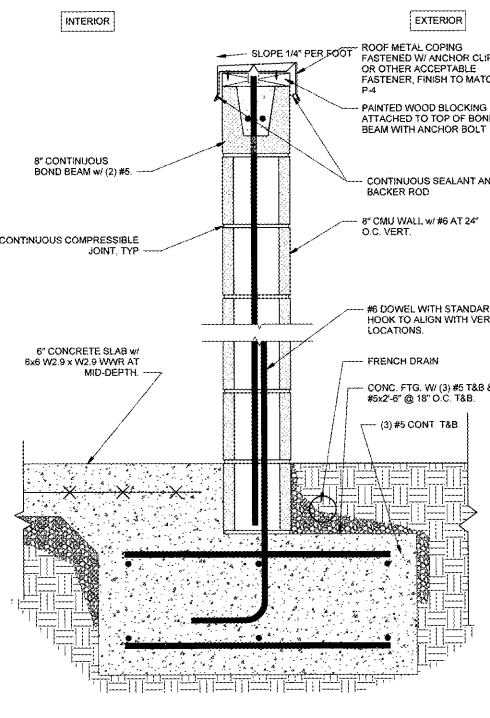

**07 trash enclosure - detail**  
SCALE | 1 1/2" = 1'-0"

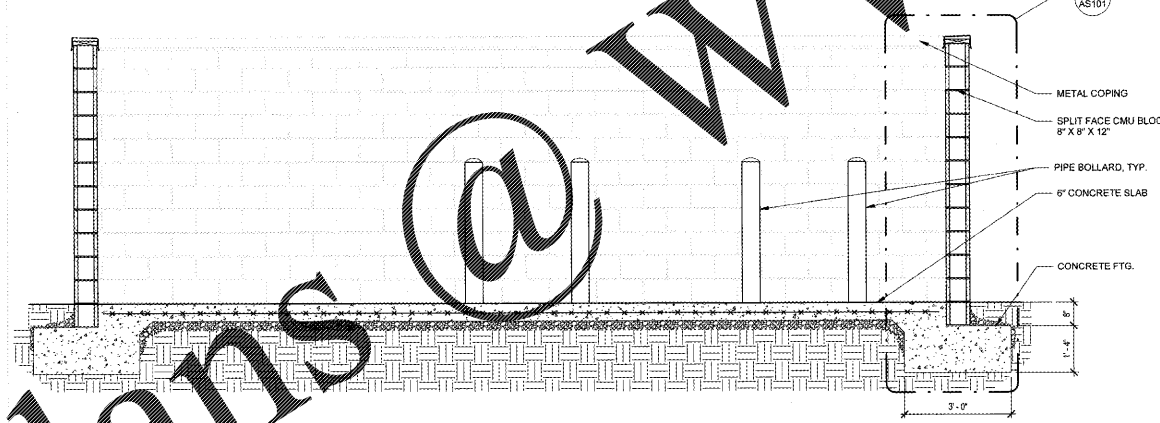

**06 trash enclosure - section**  
SCALE | 1/2" = 1'-0"

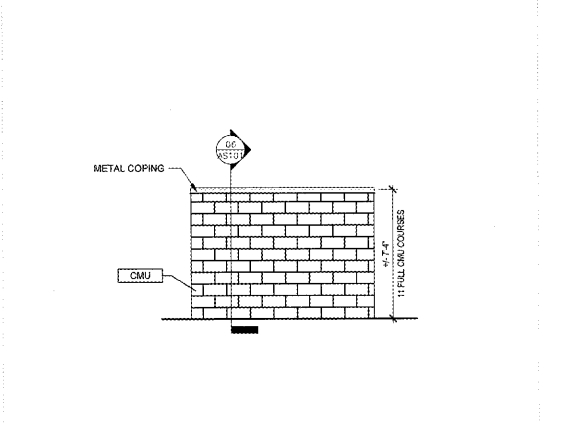

**05 trash enclosure - elevation**  
SCALE | 1/4" = 1'-0"

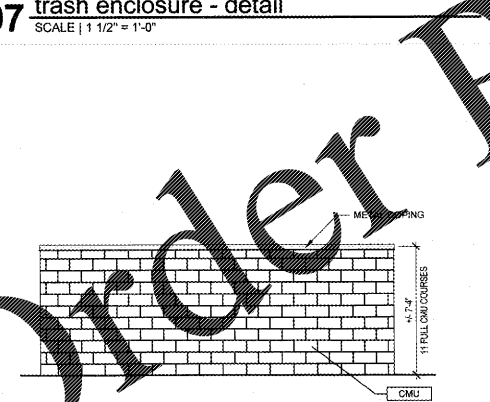

**04 trash enclosure - elevation**  
SCALE | 1/4" = 1'-0"

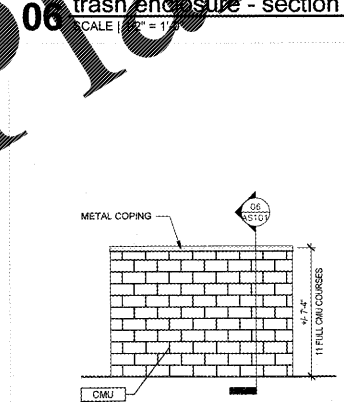

**03 trash enclosure - elevation**  
SCALE | 1/4" = 1'-0"

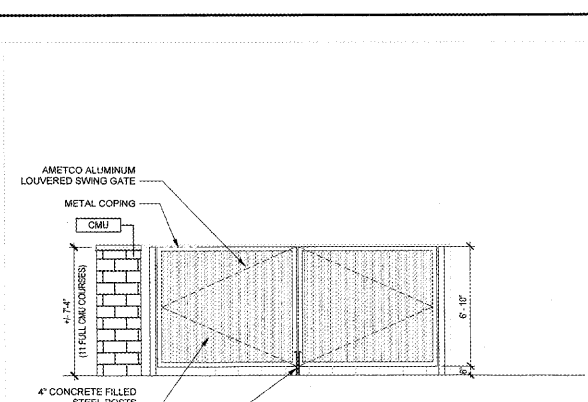

**02 trash enclosure - elevation**  
SCALE | 1/4" = 1'-0"

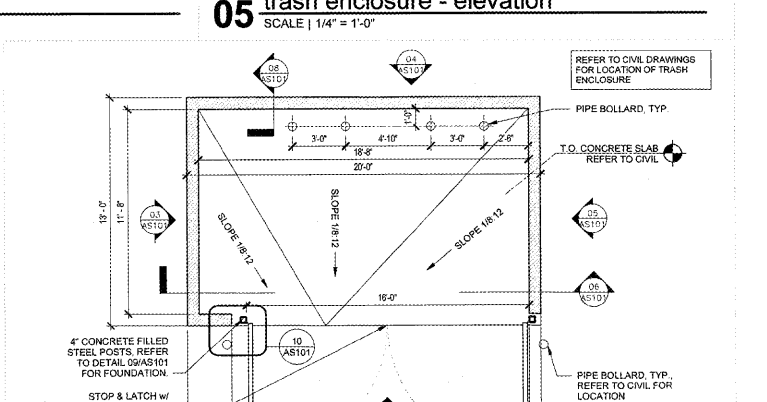

**01 trash enclosure - plan**  
SCALE | 1/4" = 1'-0"

Order Plans @ WWW.LDOnline.com