

0:14-ACTIVE JOB FILED 02/08/2018 - MURPHEY MIDDLE SCHOOL PE BUILDING AND PARKING IMPROVEMENTS - ADMINISTRATION - 11/22/2018 9:59 AM

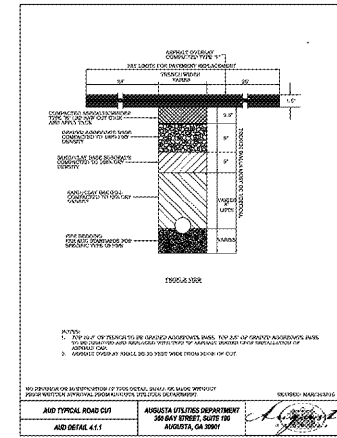

BRANSTON
ENGINEERING
ENGINEERS - PLANNERS - SURVEYORS
450 Ellis Street, Augusta, Georgia 30901
P.O. Box 10000, Augusta, Georgia 30903
Phone: 706.722.1538
Email: info@branstonee.com

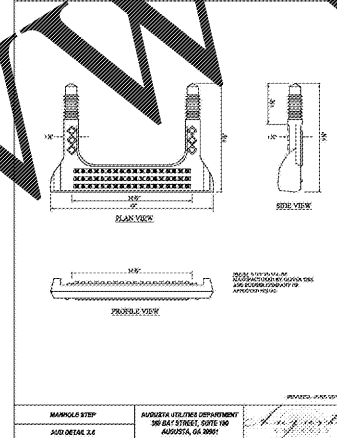
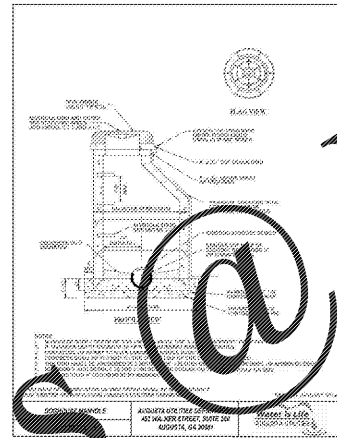
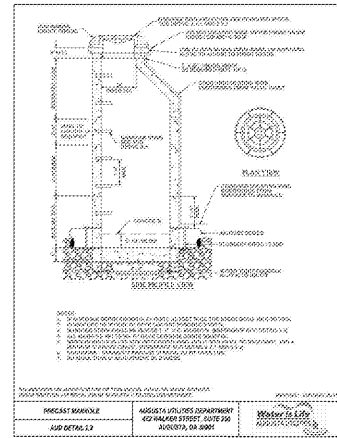
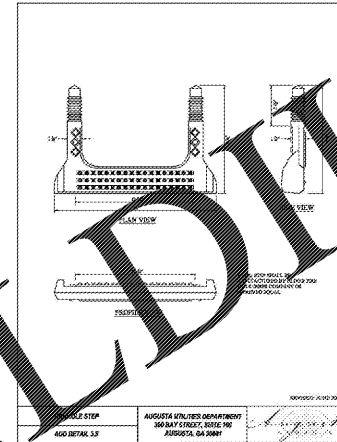
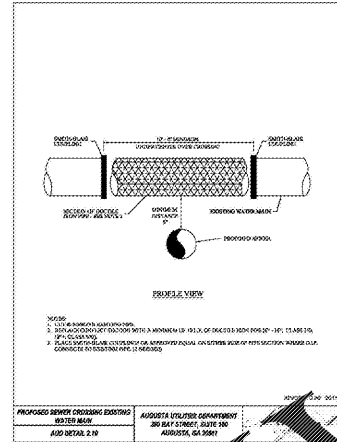
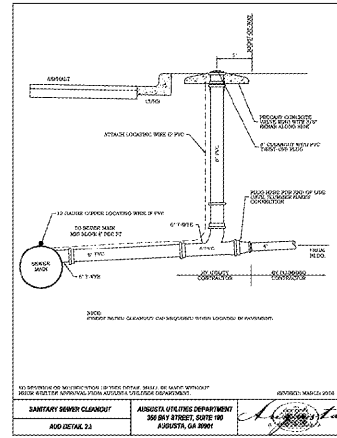
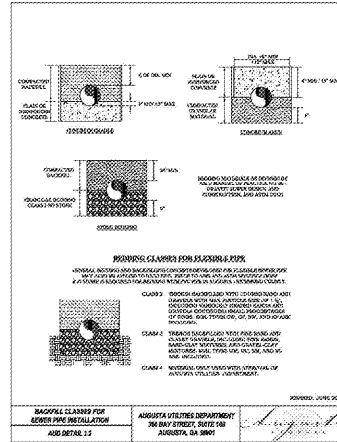

Murphey Middle School PE Building

Utility Details

DRAWN BY: MAB/RDS
CHECKED BY: TMP
APPROVED BY: MBM
DATE: NOVEMBER 2, 2018
SCALE: AS SHOWN
JOB No. 2018-0178
DRAWING No. **C703**

dickinson
ARCHITECTS
Architecture | Interior Design | Planning
771 Broad Street, Suite 200
Augusta, Georgia 30901
772-7488
info@dickinsonarchitects.com
www.dickinsonarchitects.com

Member of the
American Institute of
Architects

THIS DRAWING IS THE PROPERTY OF DICKINSON ARCHITECTS, P.C. AND IS NOT TO BE REPRODUCED OR COPIED IN WHOLE OR IN PART OR USED FOR ANY PURPOSES WITHOUT THE CONSENT OF THE ARCHITECT. ANY UNAUTHORIZED REPRODUCTION OR USE OF THIS DRAWING IS STRICTLY PROHIBITED. © 2018 DICKINSON ARCHITECTS, P.C.

PROJECT TITLE:
MURPHEY MIDDLE SCHOOL PE BUILDING
PROJECT #
B-17-005-3756.1

REVISIONS			
REV #	DATE	APPRD BY	REVISION
11/02/18	MBM	STATE FINAL	
11/20/18	MBM	ISSUE FOR BID	

DA PROJECT NUMBER & NAME:
1707.1

DRAWING TITLE:
UTILITY DETAILS

DRAWING NO.:
C703