

CIVIL:
 Choctaw Engineering, Inc.
 112 Truxton Avenue
 Fort Walton Beach, FL 32547
 Phone: (850) 862-6211
 Fax: (850) 863-8059
 Email: msiner@choctaweng.com

STRUCTURAL:
 Winsorite Engineering Services, LLC
 122 Nut Tree Court
 Lexington, SC 29074
 Phone: (803) 957-4008
 Email: bil@weslex.com

MEP:
 Allied Consulting Engineers
 2905-D Queen City Drive
 Charlotte, NC 28208
 Phone: (704) 399-3943
 Email: dbelk@allied-engineers.com

REVISIONS		
No.	Date	Description

Information contained on this drawing and in all digital files associated is authorized for use on the project named herein only and is the property of MISHRA ARCHITECTURE PLLC and may not be reproduced in any manner without express written or verbal permission from authorized individuals. Original drawing is 24"x36" and scales are as indicated © 2008 MISHRA ARCHITECTURE PLLC

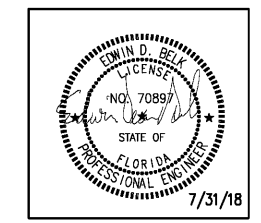

KEY PLAN

VTM Hotels, LLC

Home2Suites

2630 Wilde Lake Blvd.
 Pensacola, FL 32526

Drawing Title
 Mechanical Details

Phase
 Construction Documents

Project No.	17-101	Sheet No.	M003
Prepared by	CRM		
Checked by	PSH		
Date	July 31, 2018		

Review

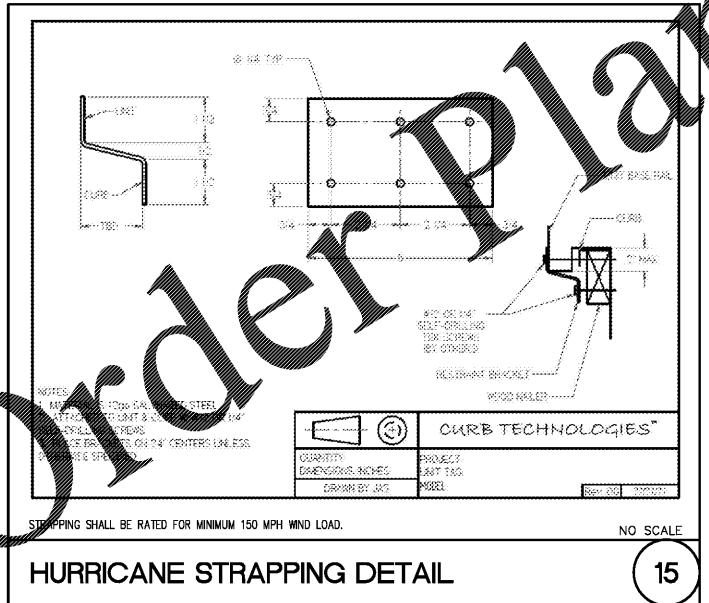
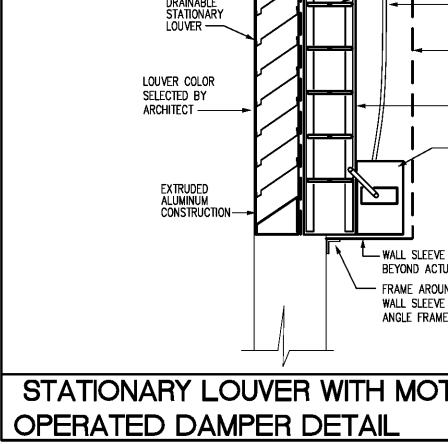
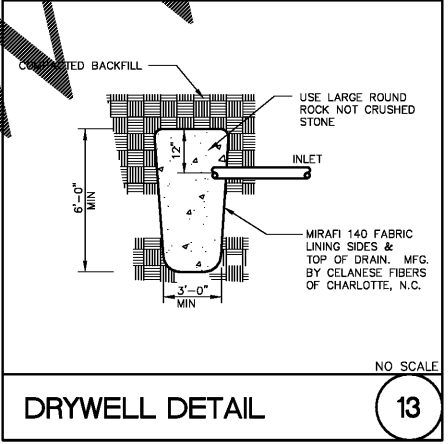
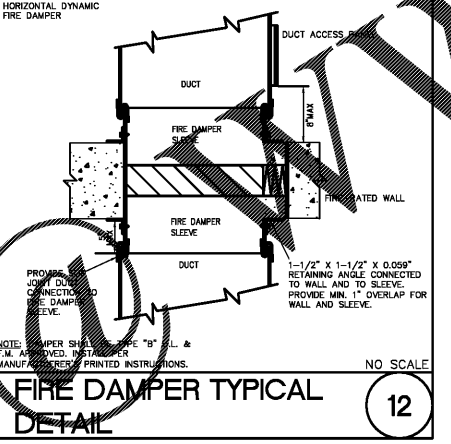
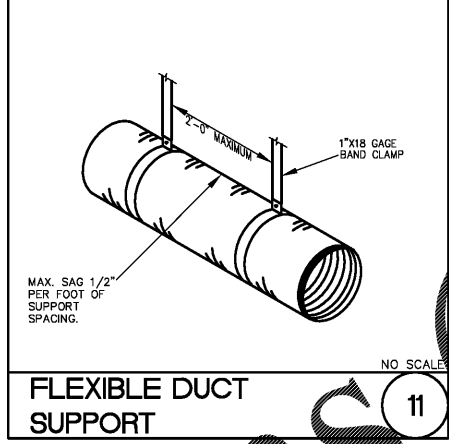
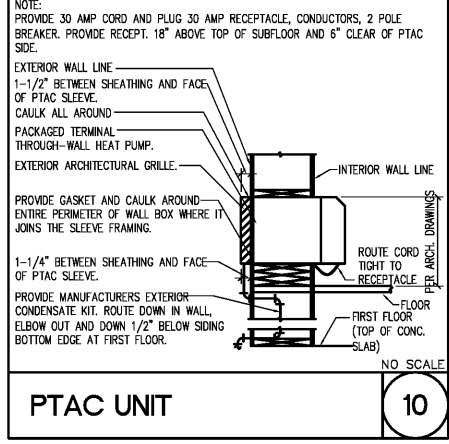
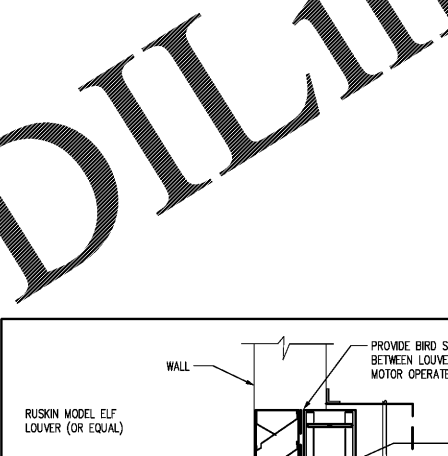
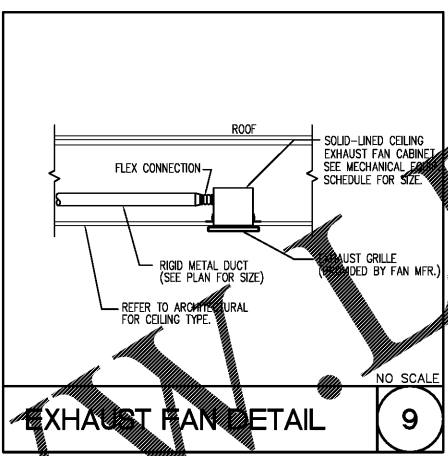
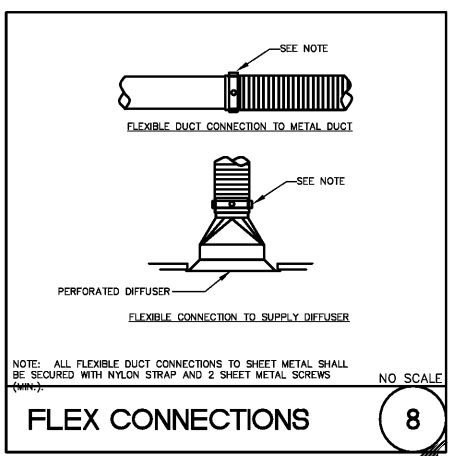
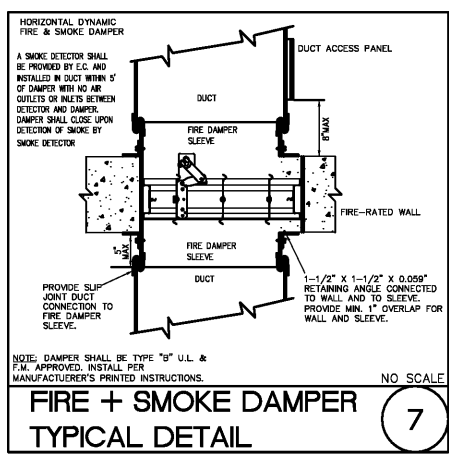
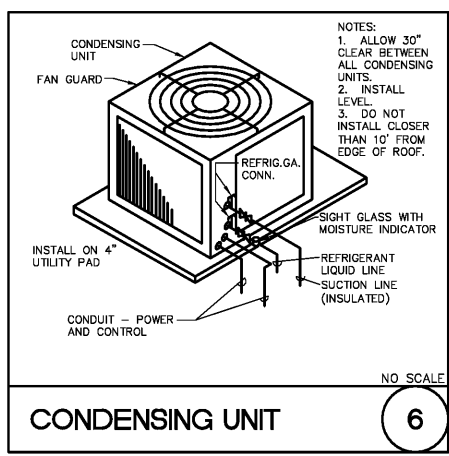
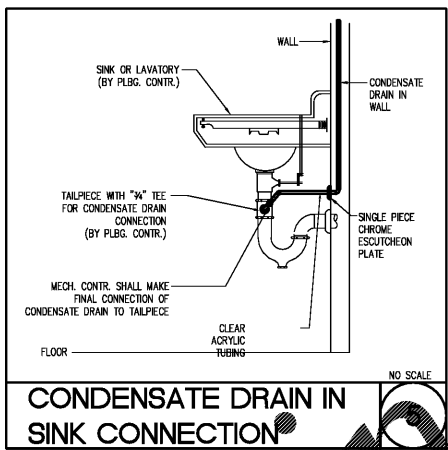
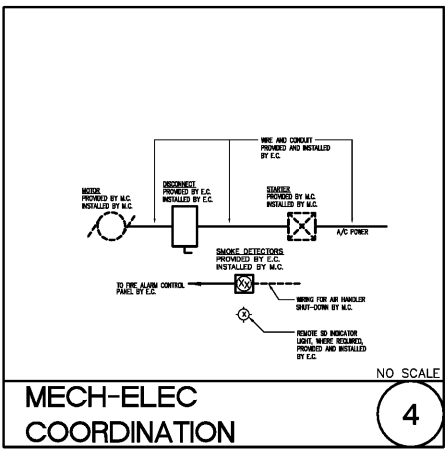
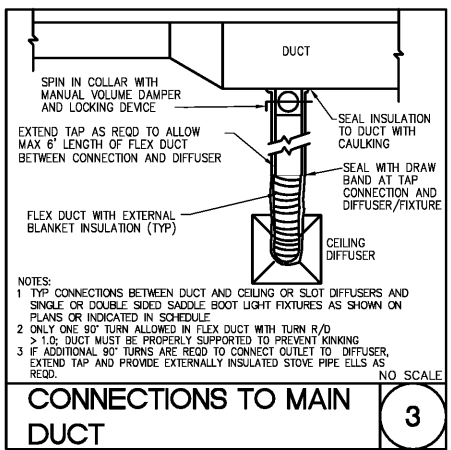
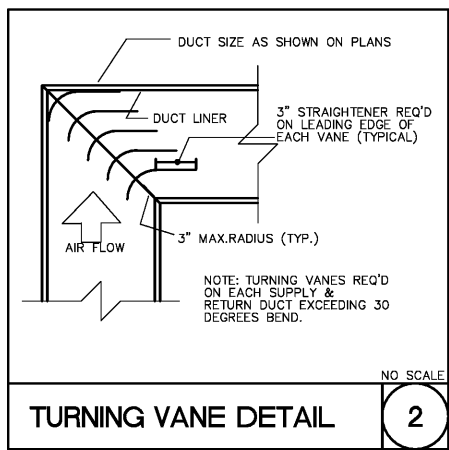
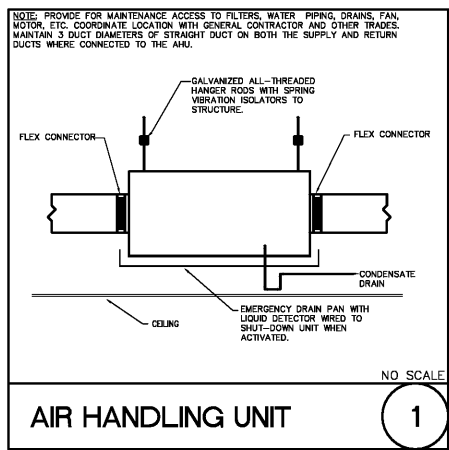

Order Plans