

Order Plans

www.dline.com

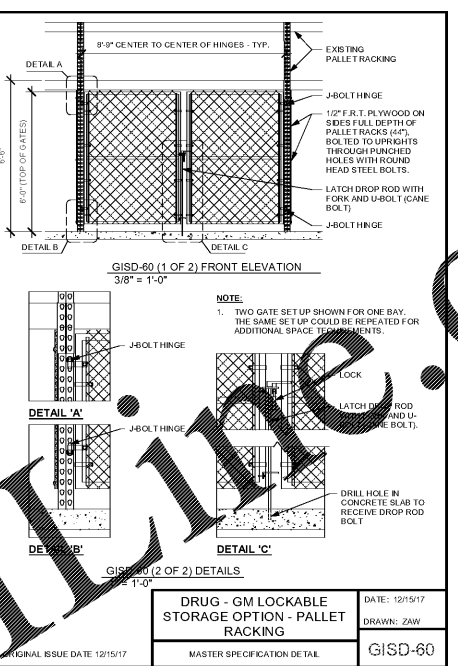
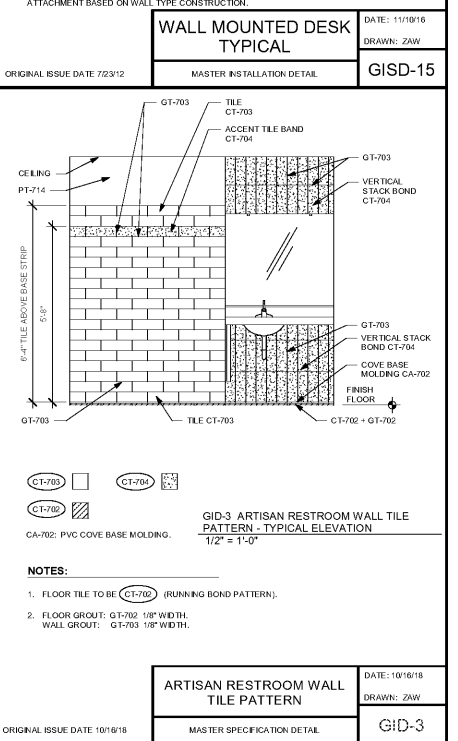
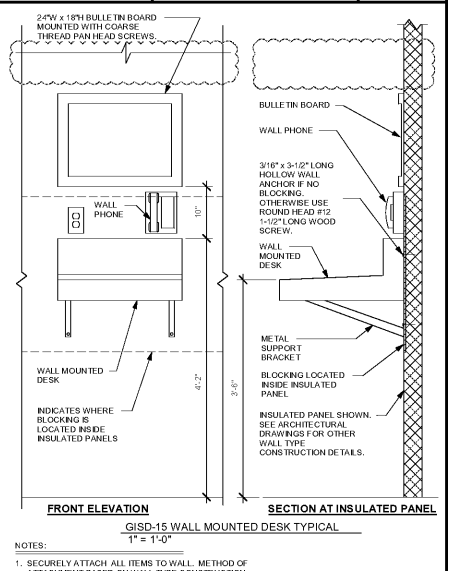
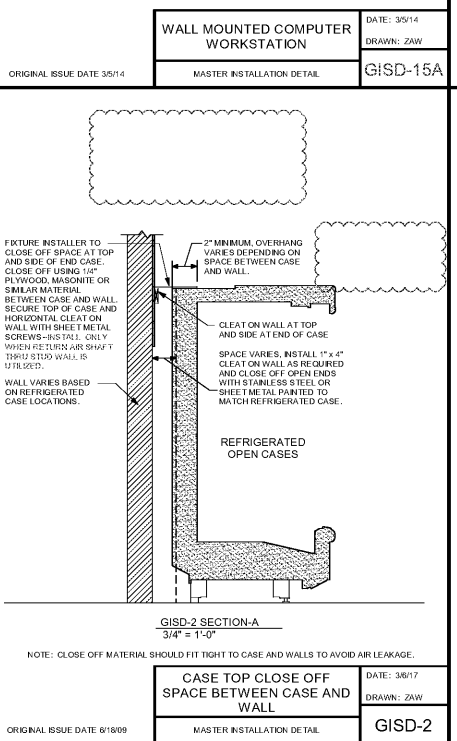
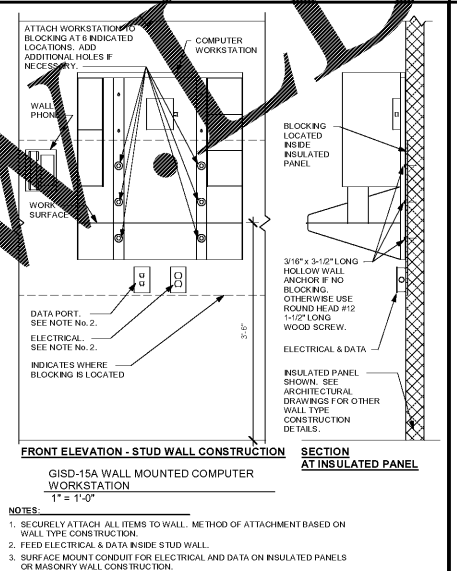
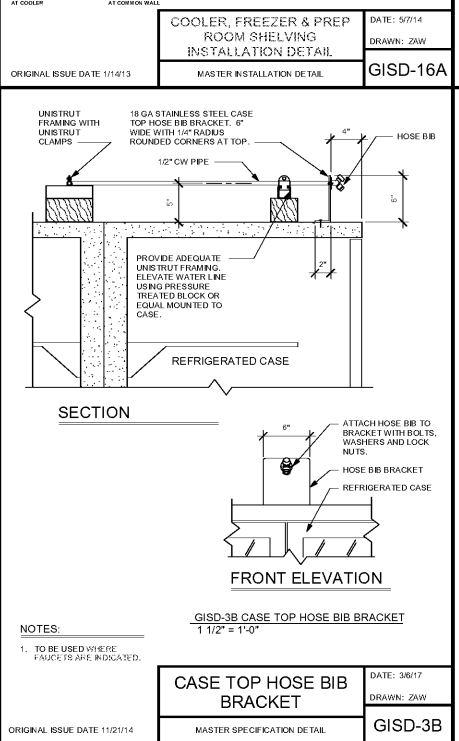
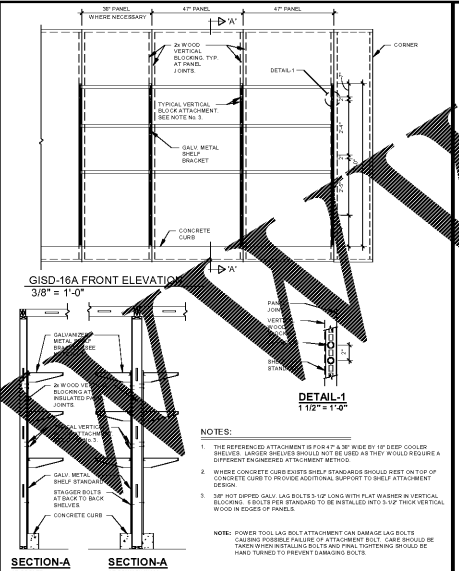
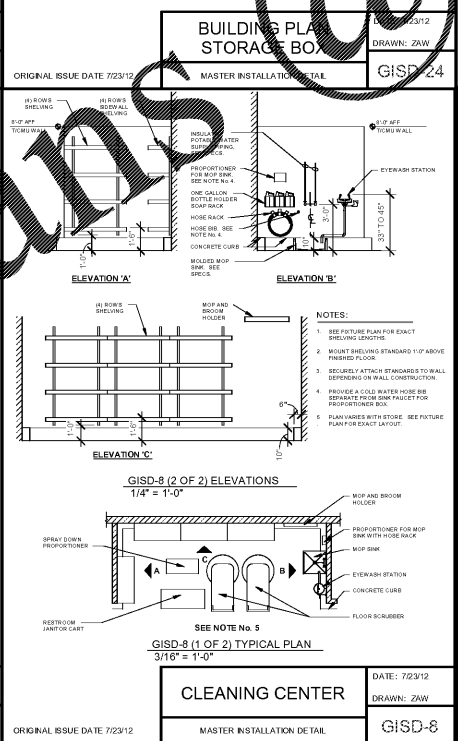
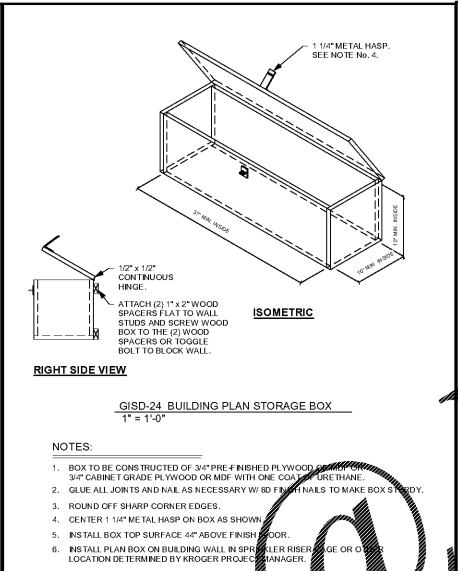
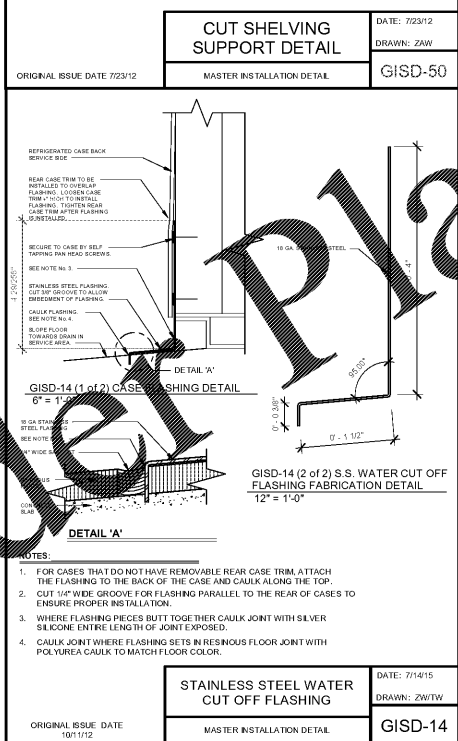
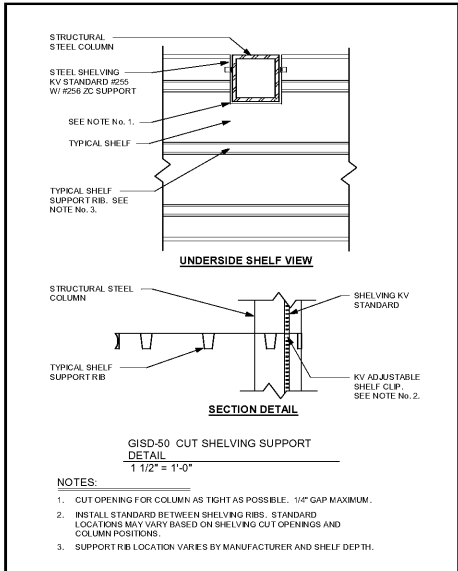

CUT SHELVING SUPPORT DETAIL	DATE: 7/23/12	DRAWN: ZAW
MASTER INSTALLATION DETAIL	GISD-50	

BUILDING PLAN STORAGE BOX	DATE: 7/23/12	DRAWN: ZAW
MASTER INSTALLATION DETAIL	GISD-24	

COOLER, FREEZER & PREP ROOM SHELVING INSTALLATION DETAIL	DATE: 5/7/14	DRAWN: ZAW
MASTER INSTALLATION DETAIL	GISD-16A	

WALL MOUNTED COMPUTER WORKSTATION	DATE: 3/5/14	DRAWN: ZAW
MASTER INSTALLATION DETAIL	GISD-15A	

WALL MOUNTED DESK TYPICAL	DATE: 11/19/16	DRAWN: ZAW
MASTER INSTALLATION DETAIL	GISD-15	

STAINLESS STEEL WATER CUT OFF FLASHING	DATE: 7/14/15	DRAWN: ZAW/TW
MASTER INSTALLATION DETAIL	GISD-14	

CLEANING CENTER	DATE: 7/23/12	DRAWN: ZAW
MASTER INSTALLATION DETAIL	GISD-8	

CASE TOP HOSE BIB BRACKET	DATE: 3/6/17	DRAWN: ZAW
MASTER SPECIFICATION DETAIL	GISD-3B	

CASE TOP CLOSE OFF SPACE BETWEEN CASE AND WALL	DATE: 3/6/17	DRAWN: ZAW
MASTER INSTALLATION DETAIL	GISD-2	

ARTISAN RESTROOM WALL TILE PATTERN	DATE: 10/16/18	DRAWN: ZAW
MASTER SPECIFICATION DETAIL	GISD-3	

EXECUTED BY: [Signature]
 REVIEWED BY: [Signature]
 PROJECT TITLE: [Blank]
 PROJECT NO.: [Blank]
 SHEET NO.: [Blank]
 DATE: [Blank]

DRUG - GM LOCKABLE STORAGE OPTION - PALLET RACKING
 DATE: 12/15/17
 DRAWN: ZAW
 MASTER SPECIFICATION DETAIL
 GISD-60

OWNER: Kroger
 DATE: 8/23/18
 10% OWNER REVIEW
 11/01/2018 100% PERMIT

PROJECT TITLE: KROGER STORE R543
 1953 W. Mercury Blvd.
 Hampton, VA 23666

COMMISSION NO: 518344
 ISSUE DATE: 11/01/18
 SHEET TITLE: INTERIOR STANDARD DETAILS (GISD)
 SHEET NO: 15.1