

DOCK DOORS INSTALLATION
DATE: 1/30/15
DRAWN: ZAW
ORIGINAL ISSUE DATE: 2/20/06
MASTER SPECIFICATION DETAIL
ASD-152

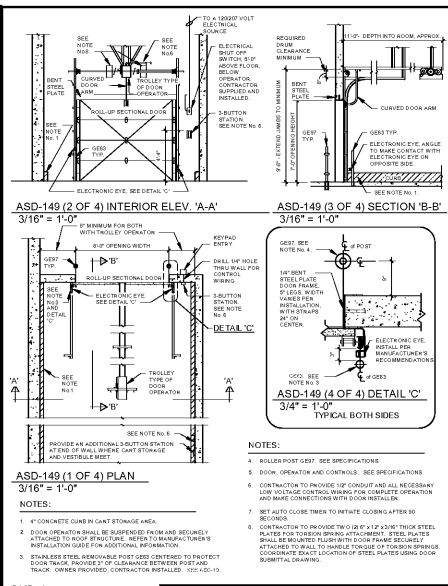

BASCART DOOR INSTALLATION WITH TROLLEY DOOR OPERATOR
DATE: 8/8/11
DRAWN: ZAW
ORIGINAL ISSUE DATE: 4/15/11
MASTER SPECIFICATION DETAIL
ASD-149

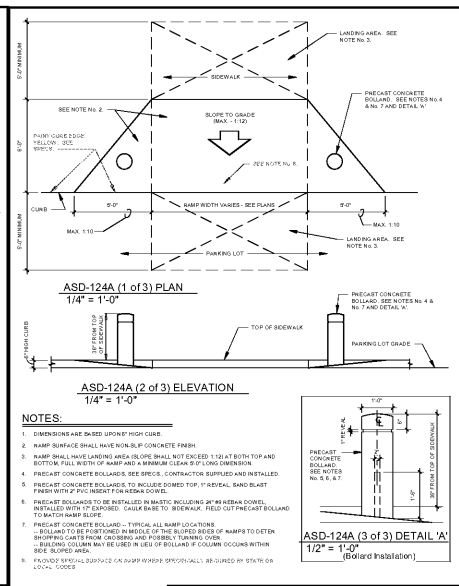

RAMP AT PEDESTRIAN CROSSING
DATE: 8/8/11
DRAWN: ZAW
ORIGINAL ISSUE DATE: 2/20/06
MASTER SPECIFICATION DETAIL
ASD-124A

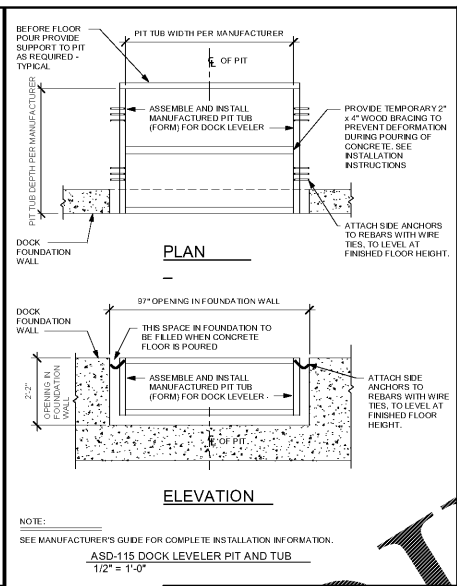

DOCK LEVELER PIT AND TUB
DATE: 2/20/06
DRAWN: ZAW
ORIGINAL ISSUE DATE: 2/20/06
MASTER SPECIFICATION DETAIL
ASD-115

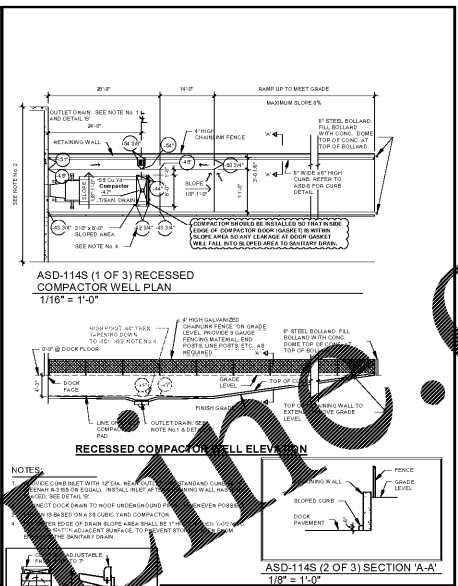

RECESSED COMPACTOR WELL
DATE: 11/7/16
DRAWN: TMM/J
ORIGINAL ISSUE DATE: 7/3/16
MASTER SPECIFICATION DETAIL
ASD-114S

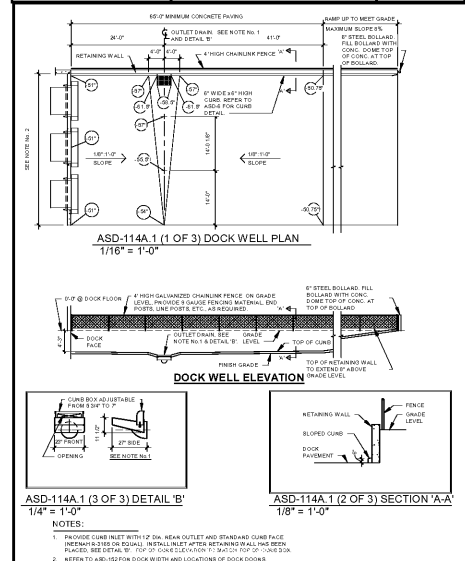

DELIVERY DOCK WITHOUT COMPACTOR AT RECESSED TRUCK WELL
DATE: 11/29/15
DRAWN: ZAW
ORIGINAL ISSUE DATE: 8/17/07
MASTER SPECIFICATION DETAIL
ASD-114A

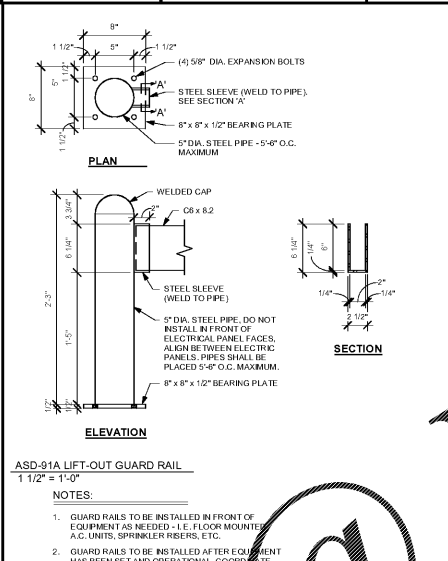

LIFT-OUT GUARD RAIL
DATE: 11/7/11
DRAWN: ZAW
ORIGINAL ISSUE DATE: 11/17/11
MASTER SPECIFICATION DETAIL
ASD-91A

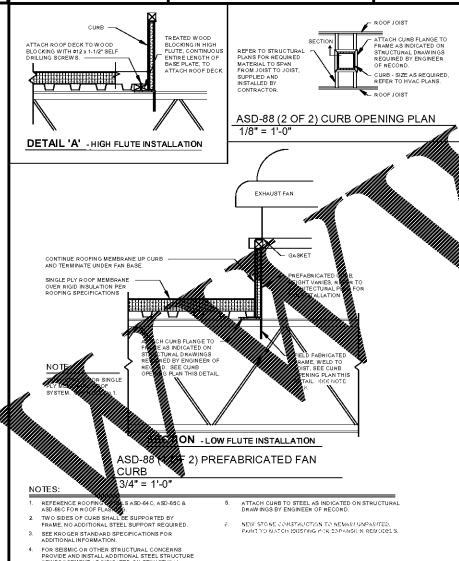

PREFABRICATED FAN CURB
DATE: 11/7/06
DRAWN: ZAW
ORIGINAL ISSUE DATE: 10/1/09
MASTER SPECIFICATION DETAIL
ASD-88

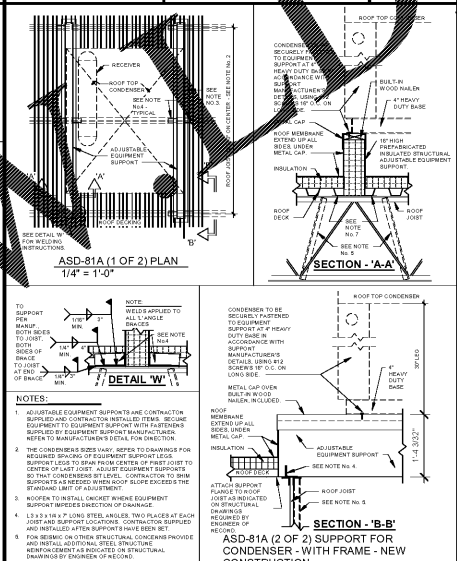

SUPPORT FOR CONDENSER WITH FRAME - NEW CONSTRUCTION
DATE: 1/30/15
DRAWN: ZAW
ORIGINAL ISSUE DATE: 10/1/09
MASTER SPECIFICATION DETAIL
ASD-81A

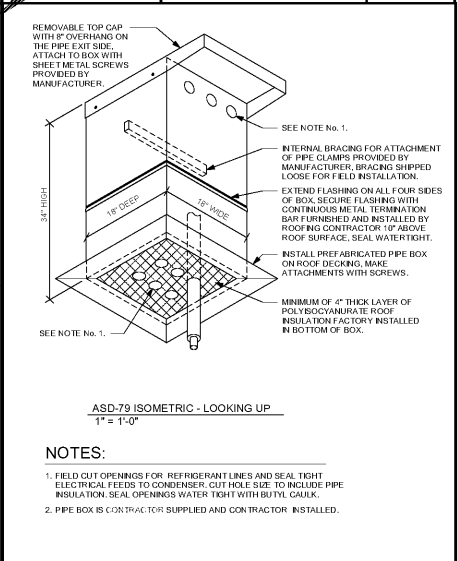

PREFABRICATED SHEET METAL BOX FOR MECHANICAL PIPING
DATE: 5/13/13
DRAWN: ZAW
ORIGINAL ISSUE DATE: 4/11/07
MASTER SPECIFICATION DETAIL
ASD-79

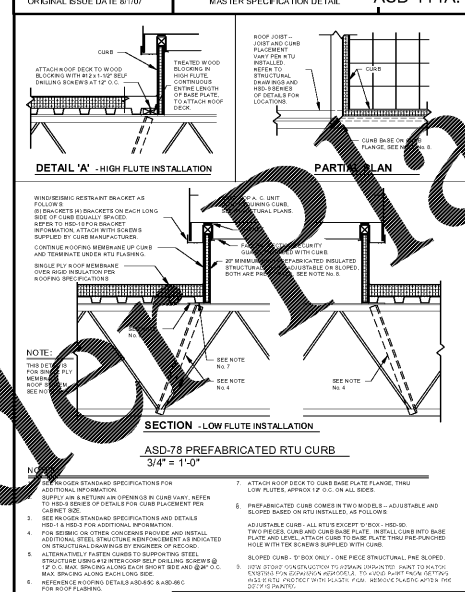

PREFABRICATED RTU CURB
DATE: 11/7/16
DRAWN: ZAW
ORIGINAL ISSUE DATE: 2/20/06
MASTER SPECIFICATION DETAIL
ASD-78

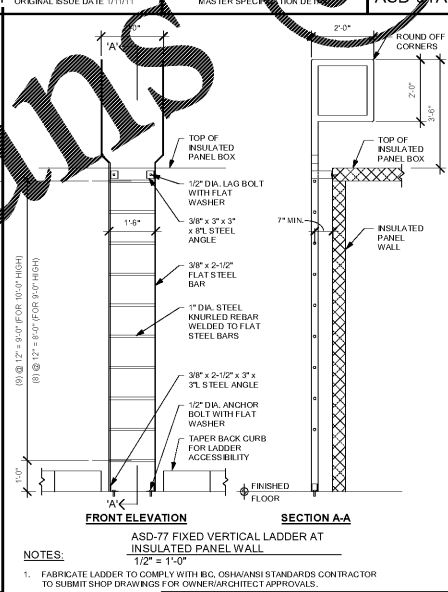

FIXED VERTICAL LADDER AT INSULATED PANEL WALL
DATE: 2/13/17
DRAWN: ZAW
ORIGINAL ISSUE DATE: 2/13/17
MASTER SPECIFICATION DETAIL
ASD-77

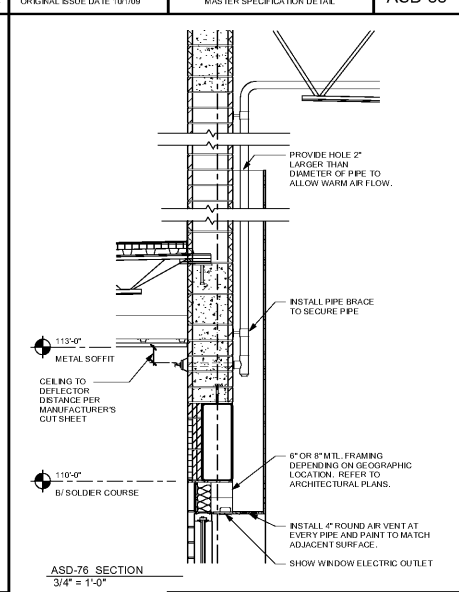

FRONT WALL FOR SPRINKLER ACCESS
DATE: 11/7/16
DRAWN: ZAW
ORIGINAL ISSUE DATE: 11/7/16
MASTER SPECIFICATION DETAIL
ASD-76

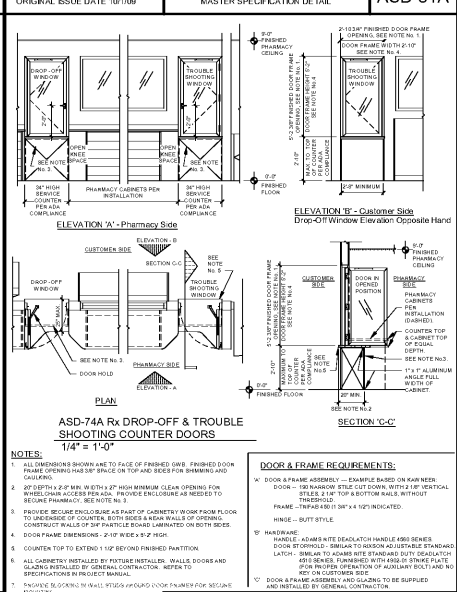

RxDROP-OFF & TROUBLE SHOOTING WINDOW COUNTER DOORS
DATE: 7/11/16
DRAWN: ZAW
ORIGINAL ISSUE DATE: 6/22/16
MASTER SPECIFICATION DETAIL
ASD-74A

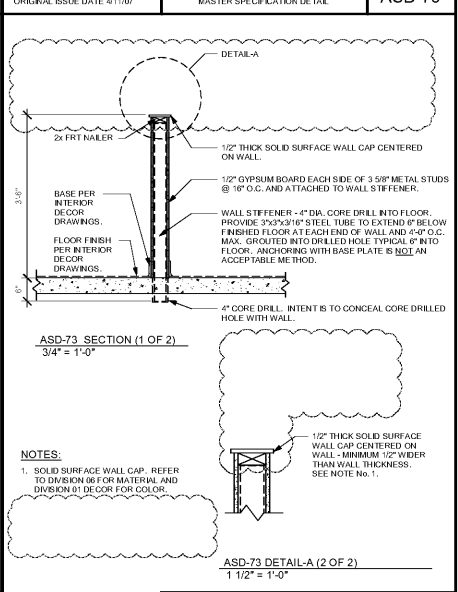

SEATING AREA LOW DIVIDING WALL
DATE: 3/24/17
DRAWN: ZAW
ORIGINAL ISSUE DATE: 5/7/14
MASTER SPECIFICATION DETAIL
ASD-73

EXECUTED BY: GB
REVIEWED BY: [Signature]
DATE: 11/10/18
PROJECT TITLE: KROGER STORE R543
SHEET TITLE: ARCHITECTURAL STANDARD DETAILS (ASD)
DRAWING NO: 518344
DATE: 11/10/18
SHEET NO: A5.1.3



OWNER: Kroger
DATE: 8/28
19/2018
11/01/2018
09X-DIR-REV
1026/PERMIT

PROJECT TITLE: KROGER STORE R543
SHEET TITLE: ARCHITECTURAL STANDARD DETAILS (ASD)

DATE: 8/28
19/2018
11/01/2018
09X-DIR-REV
1026/PERMIT
PROJECT TITLE: KROGER STORE R543
SHEET TITLE: ARCHITECTURAL STANDARD DETAILS (ASD)
DRAWING NO: 518344
DATE: 11/10/18
SHEET NO: A5.1.3