

1. 2. 3. 4. 5. 6. 7. 8. 9. 10. 11. 12. 13. 14. 15. 16. 17. 18. 19. 20. 21. 22. 23. 24. 25. 26. 27. 28. 29. 30. 31. 32. 33. 34. 35. 36. 37. 38. 39. 40. 41. 42. 43. 44. 45. 46. 47. 48. 49. 50. 51. 52. 53. 54. 55. 56. 57. 58. 59. 60. 61. 62. 63. 64. 65. 66. 67. 68. 69. 70. 71. 72. 73. 74. 75. 76. 77. 78. 79. 80. 81. 82. 83. 84. 85. 86. 87. 88. 89. 90. 91. 92. 93. 94. 95. 96. 97. 98. 99. 100.

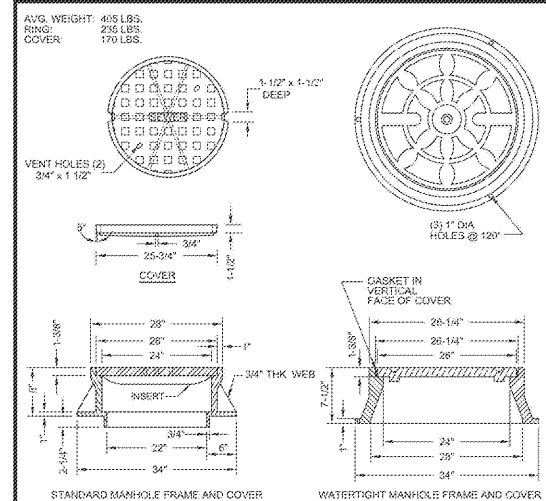

**Manhole Frame & Cover**  
October 2, 2009  
CITY OF HAMPTON, VA - DESIGN & CONSTRUCTION STANDARDS  
MH  
Revised: June 29, 2012

SEWER MANHOLE FRAME AND COVER  
NOT TO SCALE  
C-631  
8

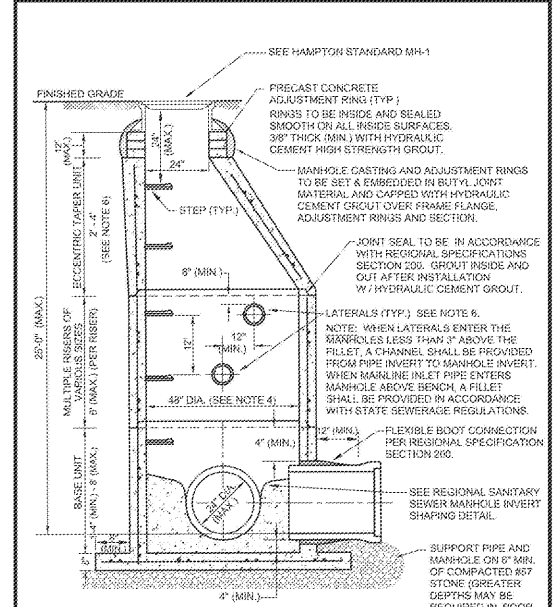

**Precast Concrete Sanitary Manhole**  
October 2, 2009  
CITY OF HAMPTON, VA - DESIGN & CONSTRUCTION STANDARDS  
PMH

SEWER MANHOLE  
NOT TO SCALE  
C-631  
6

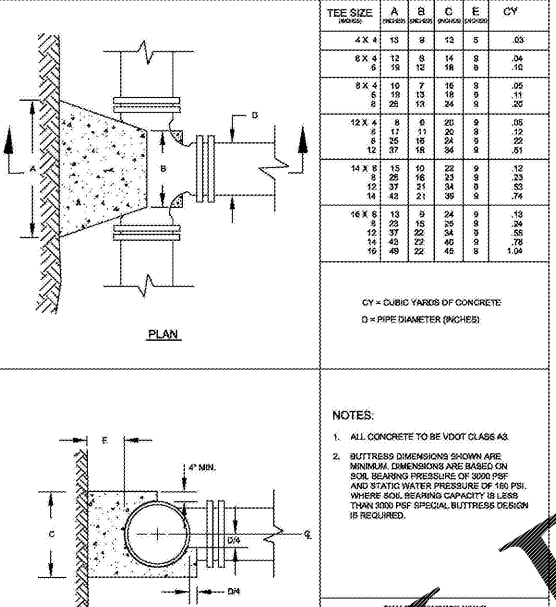

| TEE SIZE | A  | B  | C  | E | CY   |
|----------|----|----|----|---|------|
| 4 x 4    | 13 | 9  | 13 | 5 | .03  |
| 6 x 6    | 12 | 8  | 14 | 8 | .24  |
| 8 x 8    | 10 | 7  | 16 | 8 | .05  |
| 10 x 10  | 10 | 13 | 16 | 9 | .11  |
| 12 x 12  | 8  | 0  | 20 | 9 | .05  |
| 14 x 14  | 15 | 10 | 22 | 9 | .12  |
| 16 x 16  | 15 | 10 | 23 | 8 | .23  |
| 18 x 18  | 12 | 11 | 24 | 9 | .08  |
| 20 x 20  | 12 | 11 | 24 | 9 | .25  |
| 22 x 22  | 14 | 12 | 26 | 9 | .24  |
| 24 x 24  | 14 | 12 | 26 | 9 | .74  |
| 26 x 26  | 13 | 9  | 24 | 9 | .19  |
| 28 x 28  | 13 | 9  | 24 | 9 | .39  |
| 30 x 30  | 12 | 10 | 24 | 9 | .58  |
| 32 x 32  | 11 | 10 | 24 | 9 | .78  |
| 34 x 34  | 10 | 9  | 24 | 9 | 1.04 |

NOTES:  
1. ALL CONCRETE TO BE VDOT CLASS A3.  
2. BUTTRESS DIMENSIONS SHOWN ARE MINIMUM DIMENSIONS BASED ON SOIL BEARING PRESSURE OF 3000 PSF AND STATIC WATER PRESSURE OF 150 PSI. WHERE SOIL BEARING CAPACITY IS LESS THAN 3000 PSF SPECIAL BUTTRESS DESIGN IS REQUIRED.

BUTTRESSES FOR TEES  
NOT TO SCALE  
C-631  
4

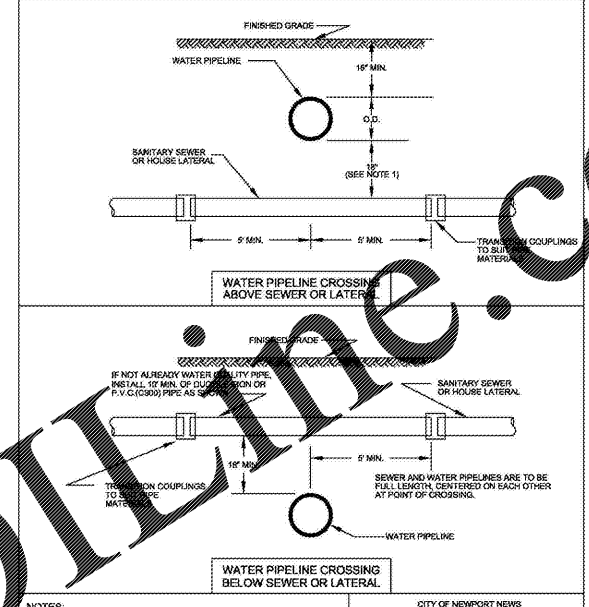

**WATER PIPELINE CROSSING**  
SANITARY SEWER/LATERAL  
October 2, 2009  
CITY OF NEWPORT NEWS  
DEPARTMENT OF PUBLIC UTILITIES  
DRWG. NO. W-674 SCALE NONE DATE 10/13/09  
DRWG. FILE NO. R-828 DWN. BY B.S. 10/13/09  
PRINT FILE NO. N-1808 CDR. BY F.R.

WATER PIPE CROSSING  
NOT TO SCALE  
C-631  
2

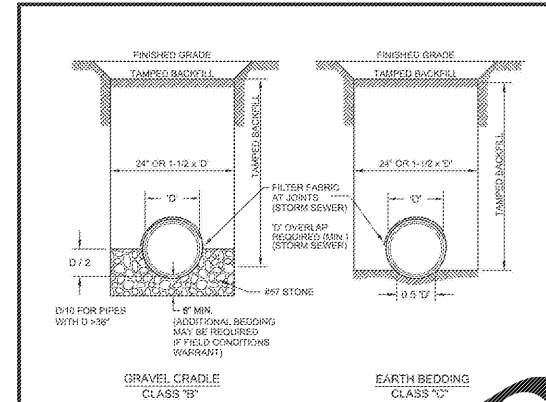

**Pipe Bedding**  
October 2, 2009  
CITY OF HAMPTON, VA - DESIGN & CONSTRUCTION STANDARDS  
PB  
Revised: June 29, 2012

SEWER PIPE BEDDING  
NOT TO SCALE  
C-631  
7

**Precast Concrete Sanitary Manhole Standard Notes**  
October 2, 2009  
CITY OF HAMPTON, VA - DESIGN & CONSTRUCTION STANDARDS  
PMH

SEWER MANHOLE STANDARD NOTES  
NOT TO SCALE  
C-631  
5

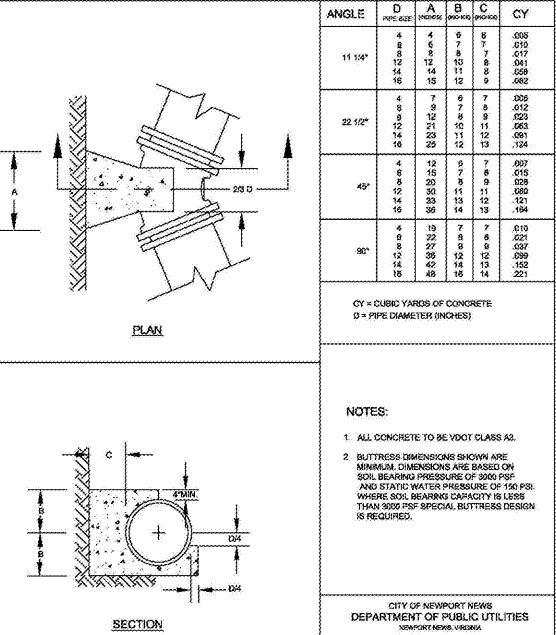

| ANGLE  | D  | A  | B  | C  | CY   |
|--------|----|----|----|----|------|
| 11.54° | 4  | 4  | 5  | 8  | .038 |
|        | 6  | 6  | 7  | 10 | .075 |
|        | 8  | 8  | 8  | 11 | .077 |
|        | 12 | 12 | 10 | 8  | .041 |
| 22.50° | 4  | 7  | 9  | 7  | .028 |
|        | 6  | 9  | 11 | 8  | .052 |
|        | 8  | 12 | 10 | 9  | .023 |
|        | 12 | 21 | 11 | 11 | .063 |
| 45°    | 4  | 12 | 9  | 7  | .007 |
|        | 6  | 18 | 7  | 8  | .015 |
|        | 8  | 20 | 9  | 9  | .028 |
|        | 12 | 38 | 12 | 12 | .089 |
| 90°    | 4  | 19 | 7  | 7  | .010 |
|        | 6  | 22 | 8  | 8  | .021 |
|        | 8  | 27 | 9  | 9  | .037 |
|        | 12 | 38 | 12 | 12 | .089 |

NOTES:  
1. ALL CONCRETE TO BE VDOT CLASS A3.  
2. BUTTRESS DIMENSIONS SHOWN ARE MINIMUM DIMENSIONS BASED ON SOIL BEARING PRESSURE OF 3000 PSF AND STATIC WATER PRESSURE OF 150 PSI. WHERE SOIL BEARING CAPACITY IS LESS THAN 3000 PSF SPECIAL BUTTRESS DESIGN IS REQUIRED.

BUTTRESSES FOR HORIZONTAL BENDS  
NOT TO SCALE  
C-631  
3

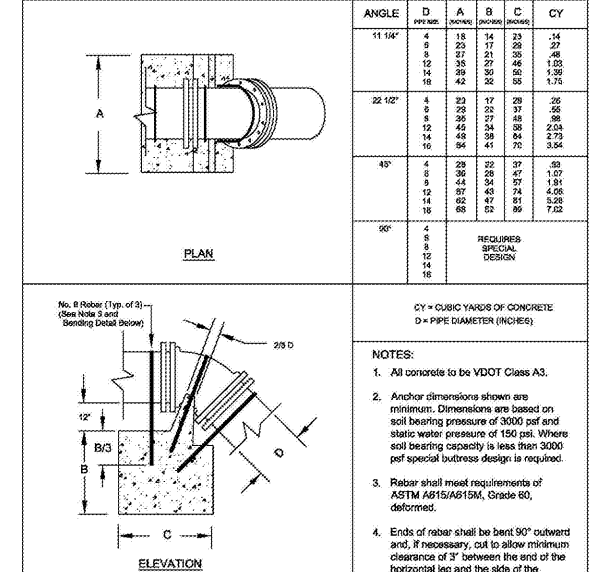

**ANCHORAGES FOR VERTICAL BENDS**  
October 2, 2009  
CITY OF NEWPORT NEWS  
DEPARTMENT OF PUBLIC UTILITIES  
DRWG. NO. W-628 SCALE NONE DATE 10/13/09  
DRWG. FILE NO. R-828 DWN. BY B.S. 10/13/09  
PRINT FILE NO. N-1808 CDR. BY F.R.

WATER ANCHORAGES AT VERTICAL BENDS  
NOT TO SCALE  
C-631  
1

**PAULSON MITCHELL**  
INCORPORATED  
PLANNERS - SURVEYORS  
ENGINEERS - ARCHITECTS  
LANDSCAPE ARCHITECTS  
200 W. HILL STREET  
SUITE 200  
ROSWELL, GEORGIA 30075  
VOICE 770.650.7685  
FAX 770.650.7684  
www.paulsonmitchell.com

PROJECT:  
**RIVERPOINTE  
PLAZA PHASE 2**  
1048 & 1050 W. MERCURY BLVD.  
HAMPTON, VIRGINIA 23666

FOR:  
**KB  
RIVERDALE,  
LLC**  
2743 PERIMETER PARKWAY  
BLDG. 100, SUITE 370  
AUGUSTA, GA 30909  
PH. (706) 854-6714

REVISIONS  
08.19.16 CITY COMMENTS  
10.04.16 CITY COMMENTS  
10.13.16 CITY COMMENTS

**va811.com**  
Dig With G.O.G.G.  
BEFORE YOU DIG, CALL MISS UTILITY 1-800-552-7071  
**24 HR EMERGENCY CONTACT**  
MARK SENN  
MARK.SENN@OUTEASTERN.COM

2014169d-2.dwg 06.28.16

UTILITY DETAILS

SHEET **C-631**

SP 2016-0020