



DATE	NO.	DESCRIPTION
03/27/18		SCHEMATIC DESIGN SUBMITTAL
04/19/18		SCHEMATIC DESIGN DEVELOPMENT
05/17/18		SCHEMATIC DESIGN SUBMITTAL
07/10/18		SCHEMATIC DESIGN CHECK - SET/ PERMIT SET
11/01/18		FINAL SCHEMATIC SUBMITTAL ISSUED FOR PROPOSALS

DOE FACILITY CODE: 660-3086
**RIVERWOOD HIGH SCHOOL PHASE 3-8
 AUDITORIUM/GYMNASIUM ADDITION**
 5900 RAIDER DRIVE NW SANDY SPRINGS, GA 30328
 FULTON COUNTY SCHOOLS RFP NO. 411-19

CHAPMAN GRIFFIN LANIER SUSENBACH ARCHITECTS
 400 Galleria Pkwy., Suite 100 Atlanta, Ga 30339 Phone: 404.733.5493

PROJECT NO. 16015.02
 DATE: 09/17/18
 DRAWN BY: Author
 CHECKED BY: Checker

AS-2.01

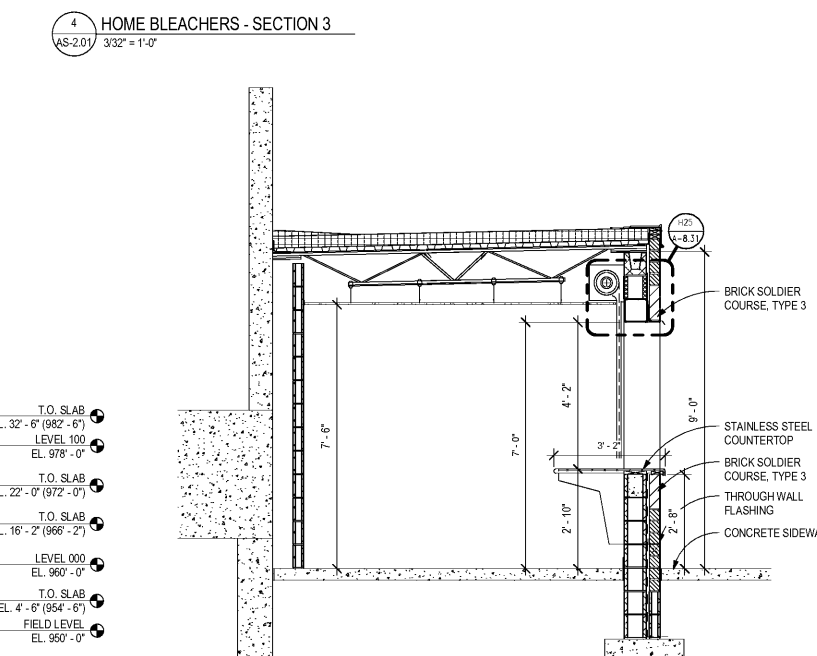
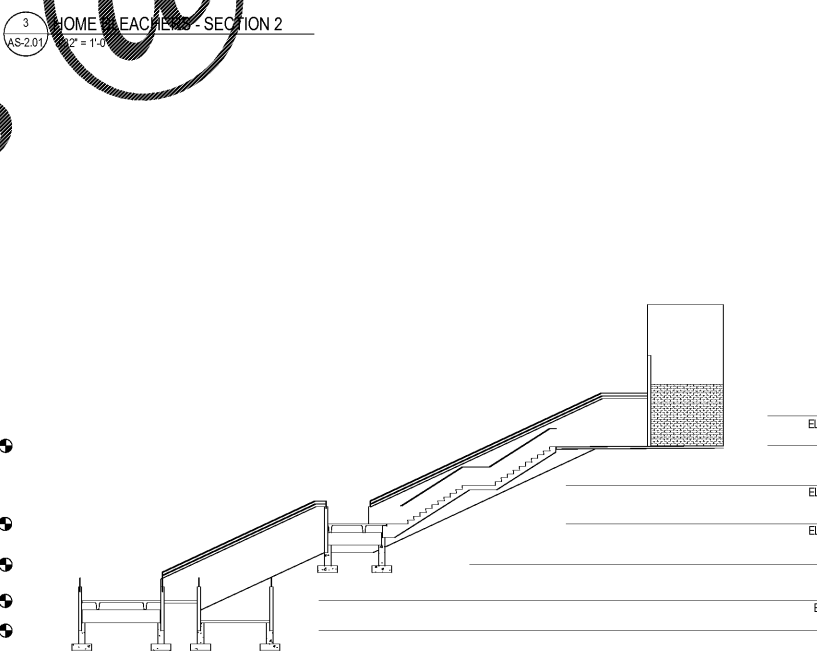
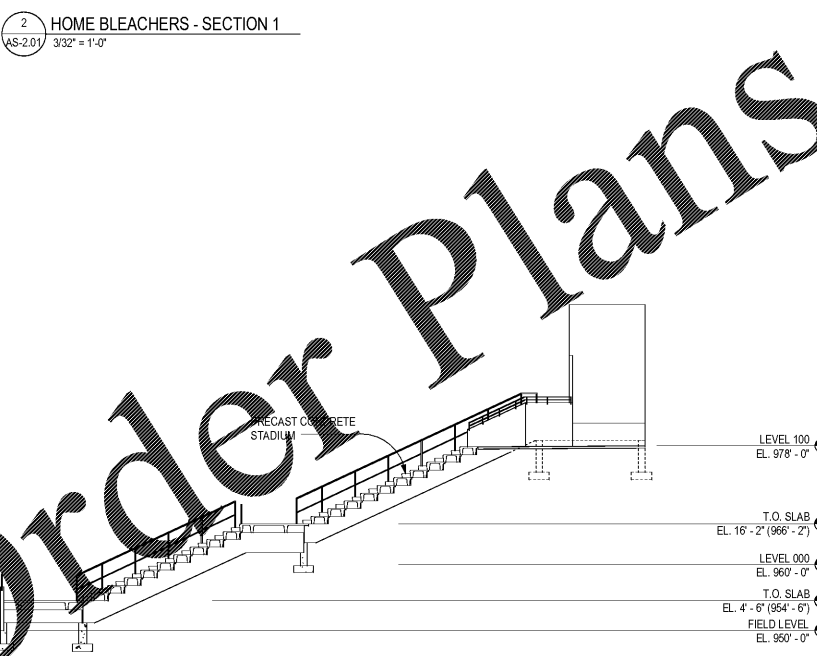
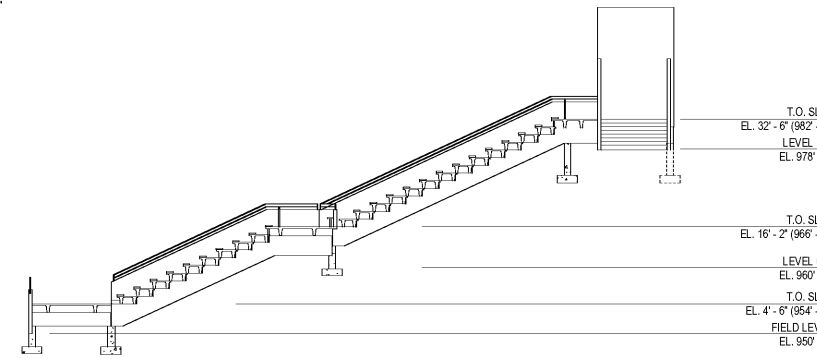
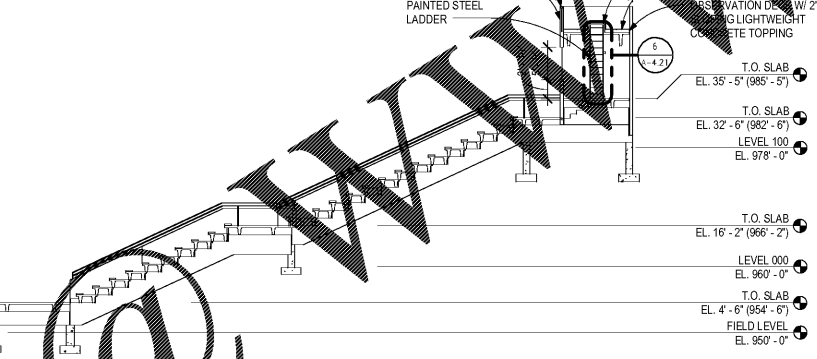
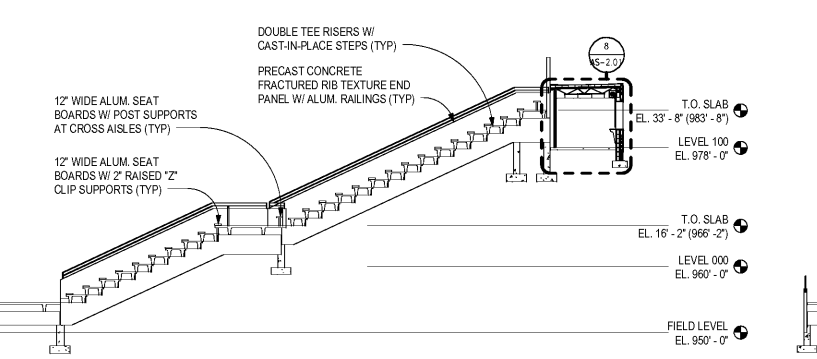
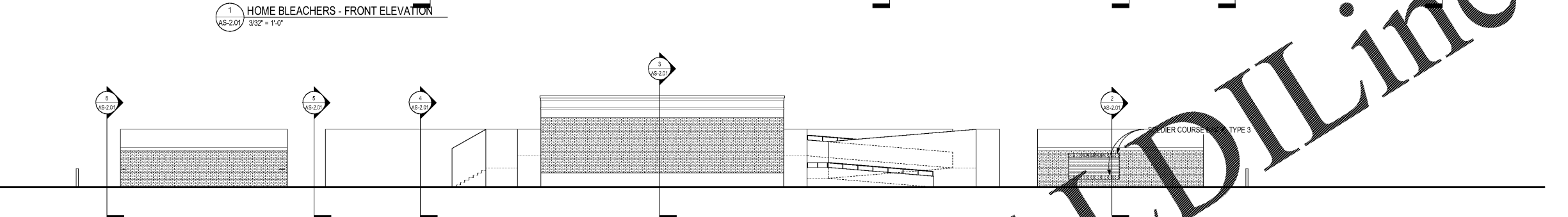
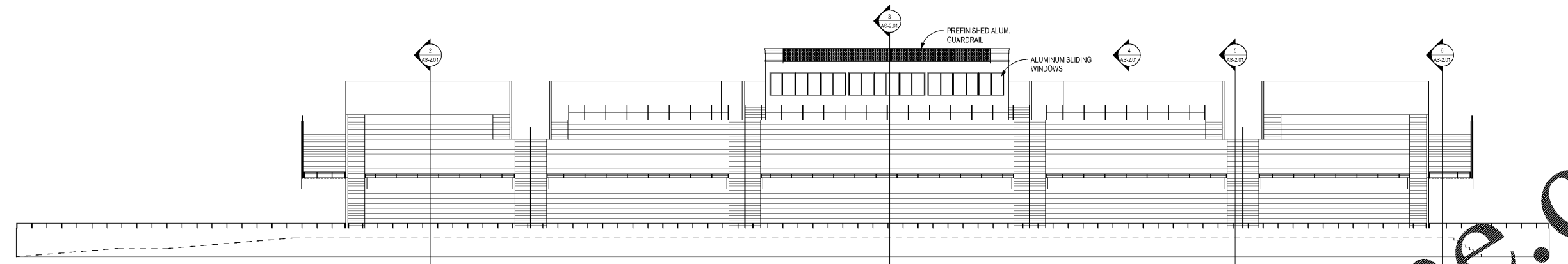

Order Plans

WWW.LDLine.com