

REVISIONS

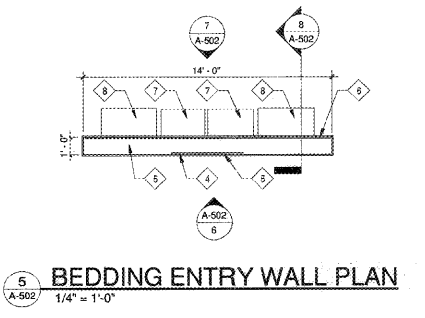

**BEDDING KEYED NOTES**

	FINISH
GENERAL NOTE: 3/8" STEEL STUD CONSTRUCTION WITH 5/8" GYPSUM BOARD FINISH, TAPE, MUDDED, PRIMED, AND PAINTED. 3/4" CORNER RADIUS ON ALL OUTSIDE CORNERS. ALL MATERIALS SUPPLIED BY G.C. UNLESS NOTED OTHERWISE.	
1	M-2
2	M-1
3	
4	
5	
6	M-2
7	M-2
8	M-3

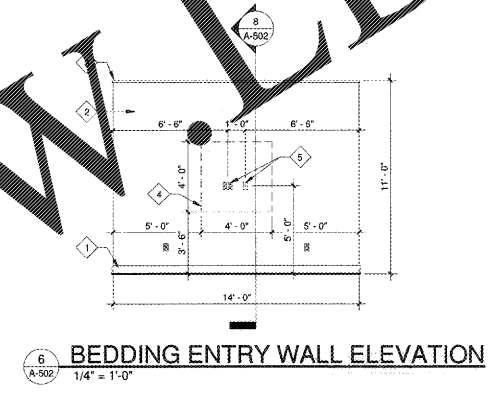
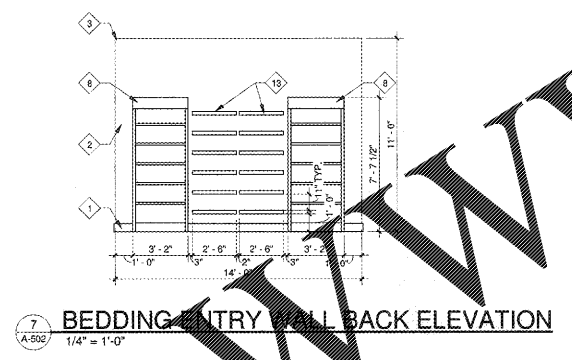
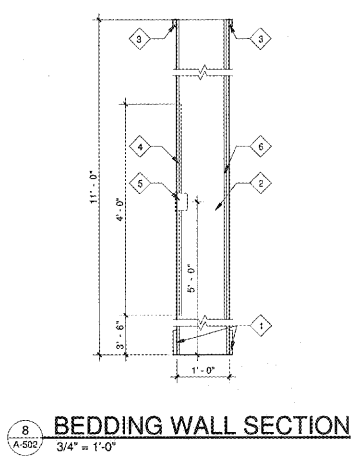

**CUSTOMER SERVICE DESK KEYED NOTES**

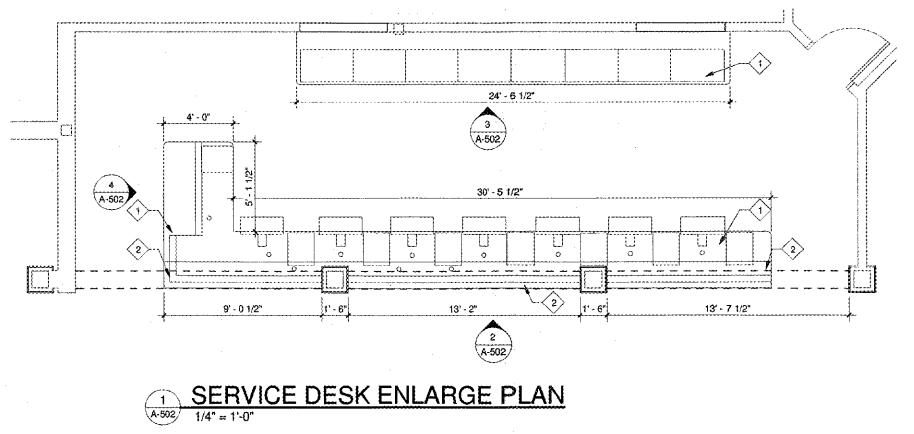
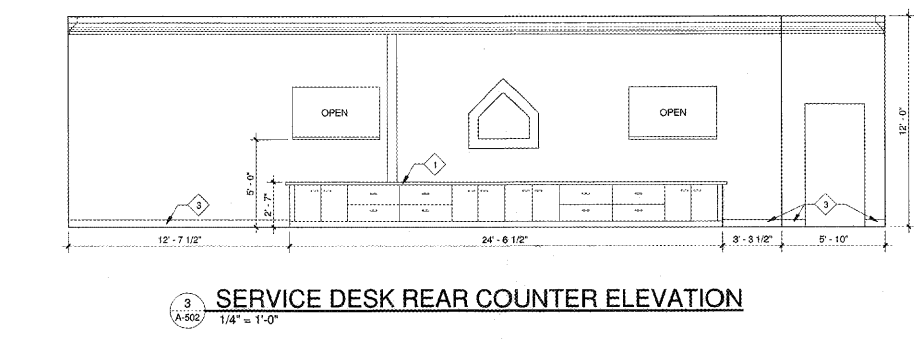
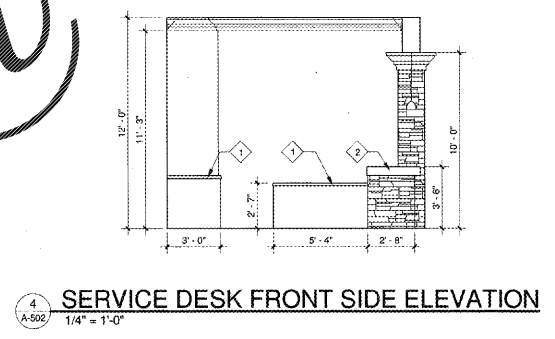
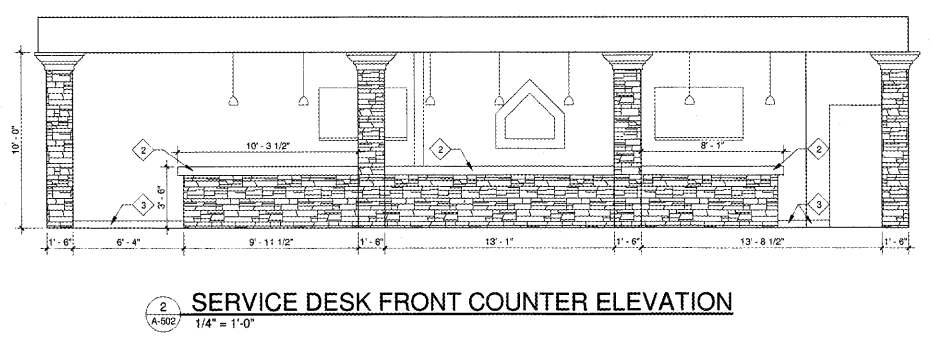
	FINISH
GENERAL NOTES: PICTURED DESK IS EXAMPLE ONLY. RESURFACE TO EXISTING DESK CONFIGURATIONS. EXISTING FINISHES TO BE REMOVED FROM DESK AND RESURFACED PER DETAILS SPECIFIED. ALL MATERIALS SUPPLIED BY G.C. UNLESS NOTED OTHERWISE.	
1	L-1
2	L-1
3	M-3



Order Plans @

WWW.LDILine.com