

DRAWING ISSUE RECORD		
DATE	REVISION	NO.
11-18	ISSUE TO BID	

SITE WORK CONSTRUCTION DETAILS
 HARMONY LELAND PLAY
 REPLACEMENT ELEMENTARY SCHOOL
 6336 FACTORY SHOALS RD IN
 MABLETON, GA 30058
 FOR COBB COUNTY SCHOOL DISTRICT
 COBB COUNTY SCHOOL DISTRICT
 CSD PROJECT NO. 14604 / JOE HADLEY
 DATE 2/26/08-08-01
 JOB NO. B-L-1260-18
 DWG. BY TMB
 CK. BY TMB

cunningham, forehand, matthews & moore
 architects, inc. - 2011 manchester street, n.e. - atlanta, georgia 30324 - phone (404) 873-2152

C7.0

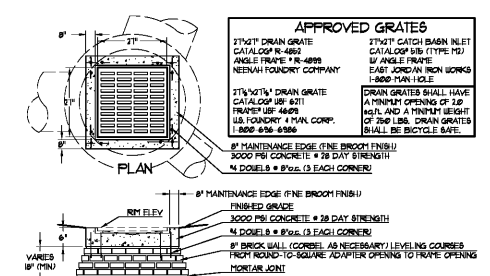

1 21" x 21" CATCH BASIN GRATE & FRAME
NOT TO SCALE

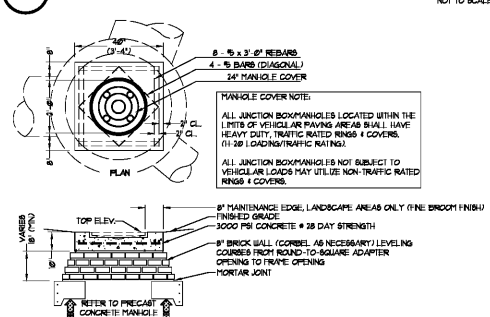

2 JUNCTION BOX / MANHOLE TOP
NOT TO SCALE

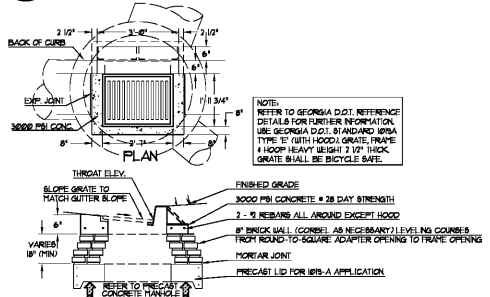

3 G.D.O.T. STANDARD 1019A CURB INLET - TYPE "E" WITH HOOD
NOT TO SCALE

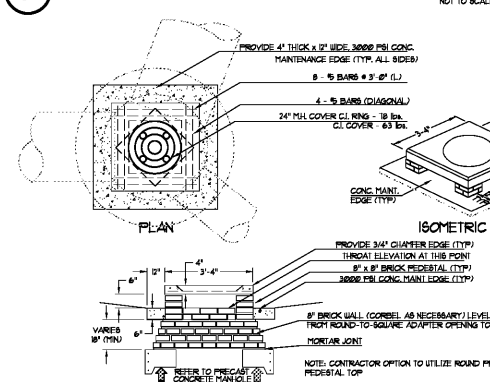

4 PRECAST DROP INLET (D.I.)
NOT TO SCALE

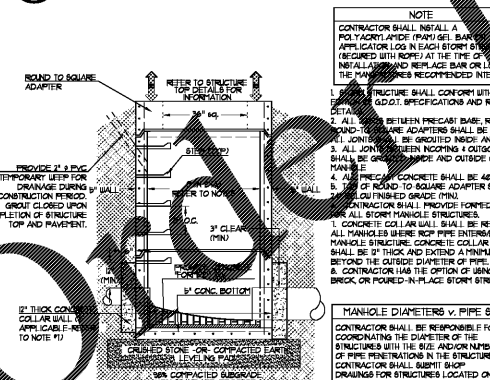

5 PRE-CAST CONCRETE MANHOLE WITH FORMED INVERT & CONCRETE WALLS
NOT TO SCALE

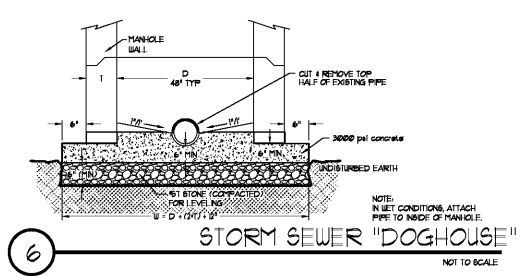

6 STORM SEWER "DOGHOUSE"
NOT TO SCALE

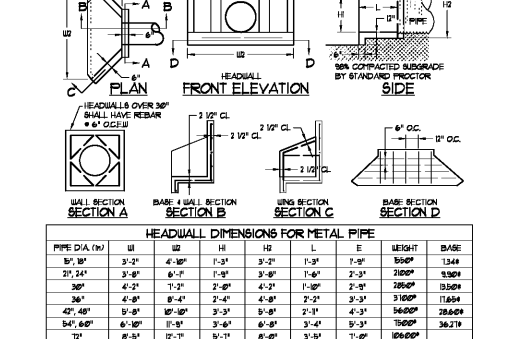

7 HEADWALL (HW)
NOT TO SCALE

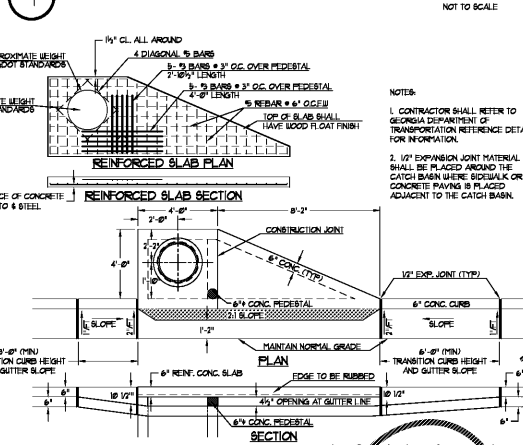

8 G.D.O.T. STANDARD 033 SINGLE-WING CATCH BASIN
NOT TO SCALE

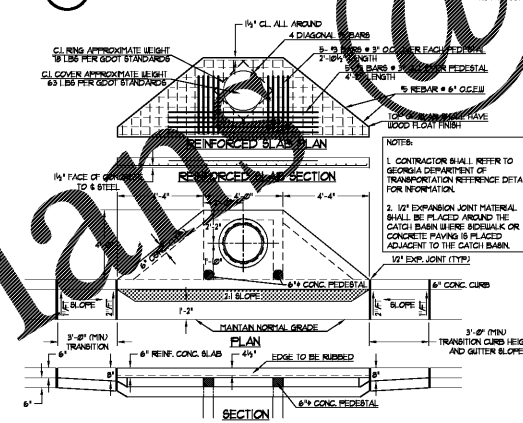

9 G.D.O.T. STANDARD 1034 DOUBLE-WING CATCH BASIN
NOT TO SCALE

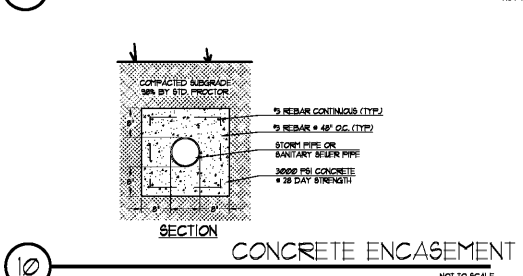

10 CONCRETE ENCASEMENT
NOT TO SCALE

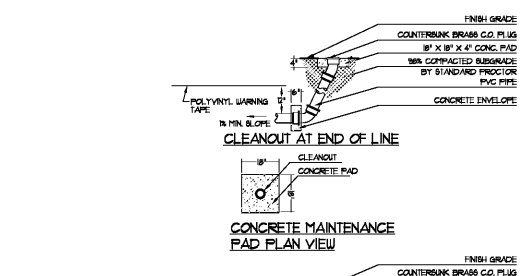

11 CLEANOUT AT END OF LINE
NOT TO SCALE

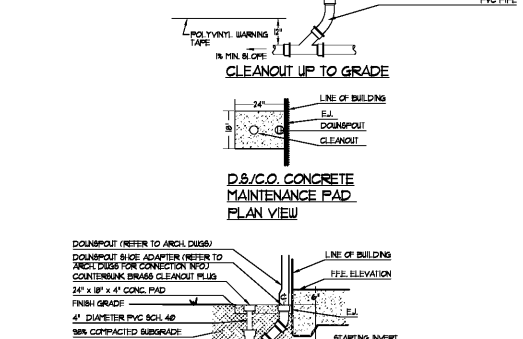

12 CLEANOUT UP TO GRADE
NOT TO SCALE

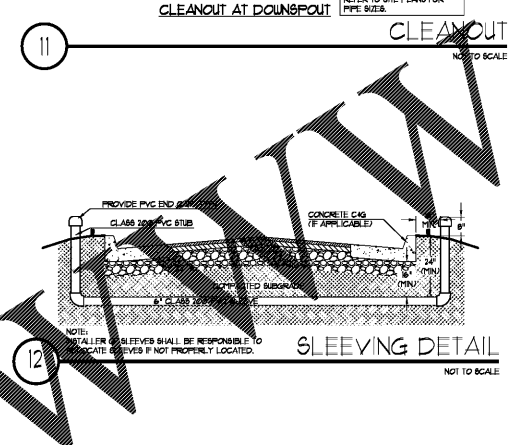

13 STORM PIPE BEDDING - NON HDPE
NOT TO SCALE

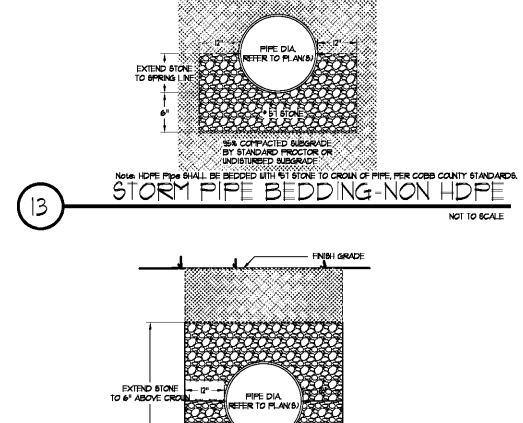

14 STORM PIPE BEDDING HDPE
NOT TO SCALE

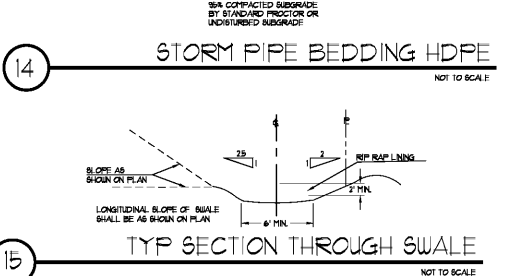

15 TYP SECTION THROUGH SWALE
NOT TO SCALE



16 AREA DRAIN NYOPLAST 15" CATCH BASIN
NOT TO SCALE

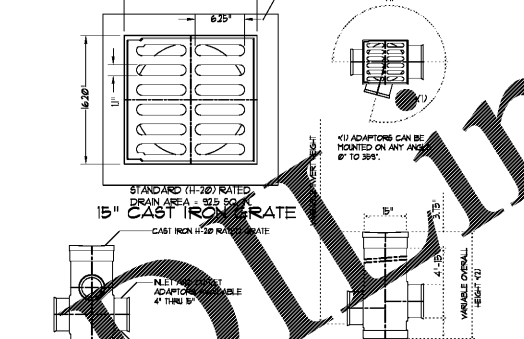

17 TRENCH DRAIN DETAIL WITH G.D.O.T. STANDARD 1019A CURB INLET
NOT TO SCALE

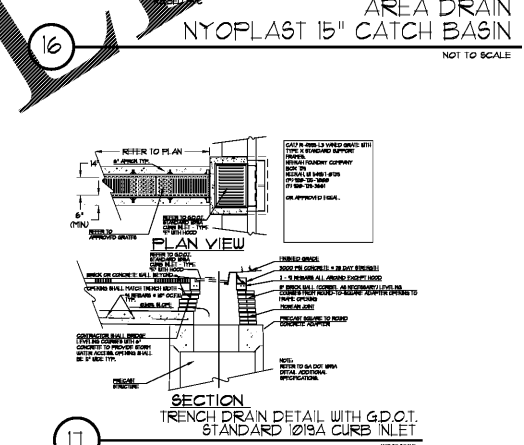

18 TRENCH DRAIN W. ADA GRATE
NOT TO SCALE

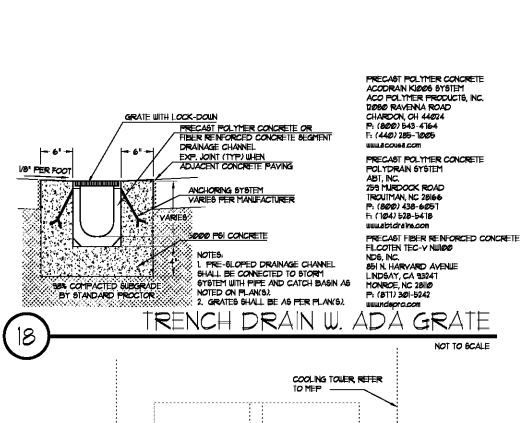

19 COOLING TOWER DRAIN
NOT TO SCALE

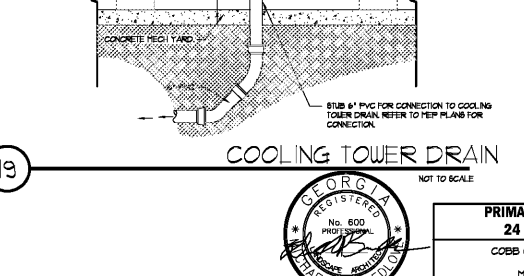

20 TYP SECTION THROUGH SWALE
NOT TO SCALE



PRIMARY PERMITTEE / 24 HR CONTACT
 COBB COUNTY SCHOOL DISTRICT
 440 GLOVER ST
 MARIETTA, GA 30066
 CONTACT: TERRY MORRIS
 PHONE: (770) 439-5854

