

1 SIGNAGE SUPPORT
CS4 1'-0\"/>

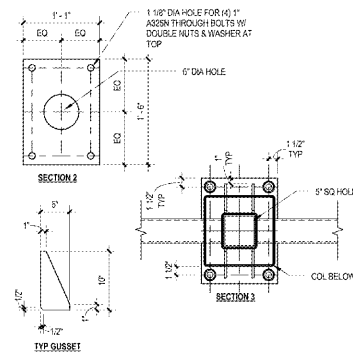

2 COLUMN TO TRUSS CONNECTION
CS4 1'-0\"/>

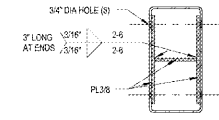

3 HSS FIELD SPLICE
CS4 1'-0\"/>

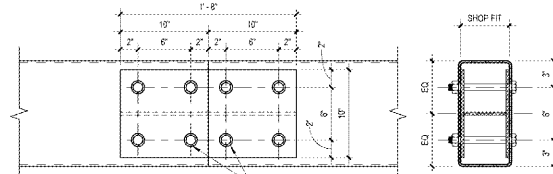

4 PERIMETER TUBE AT CORNER CONNECTION (LOW SIDE)
CS4 1'-0\"/>

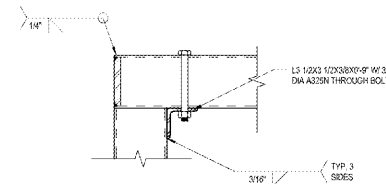

5 PERIMETER TUBE AT CORNER CONNECTION (HIGH SIDE)
CS4 1'-0\"/>

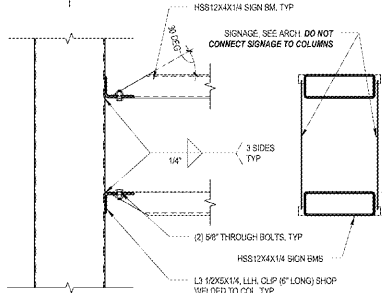

6 TRUSS CONNECTION WELDS, TYP.
CS4 1'-0\"/>

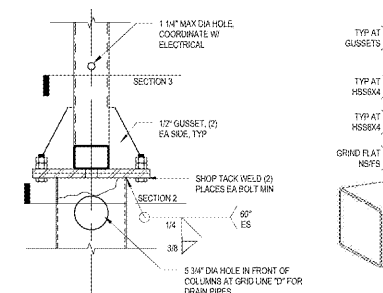

7 LIGHT SUPPORT FRAMING
CS4 1'-0\"/>

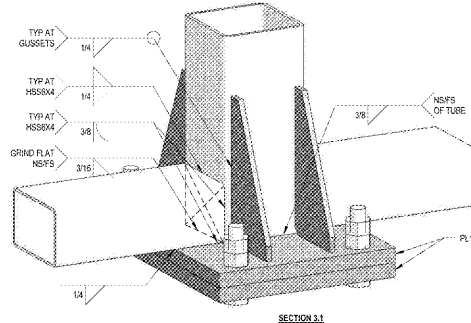

8 LOW REAR OUTRIGGER TO TRUSS CONNECTION
CS4 1'-0\"/>

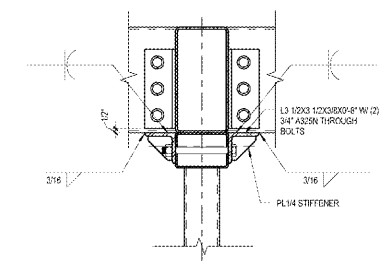

9 HIGH REAR OUTRIGGER TO TRUSS CONNECTION
CS4 1'-0\"/>

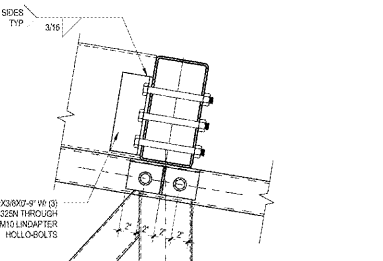

10 LOW OUTRIGGER TO TRUSS CONNECTION
CS4 1'-0\"/>

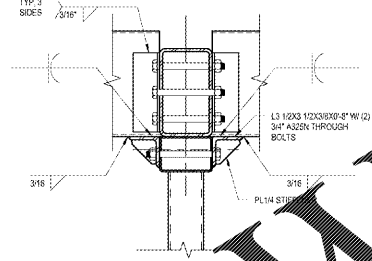

11 HIGH OUTRIGGER TO TRUSS CONNECTION
CS4 1'-0\"/>

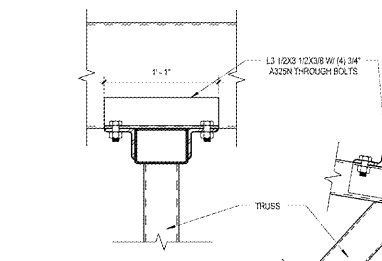

12 TRUSS TO PURLIN CONNECTION, UON
CS4 1'-0\"/>

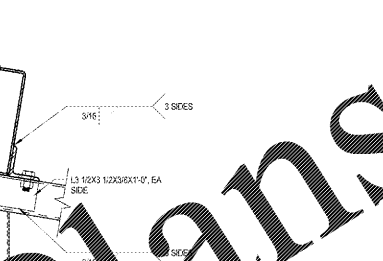

13 LOW HSS TO HSS CONNECTION
CS4 1'-0\"/>

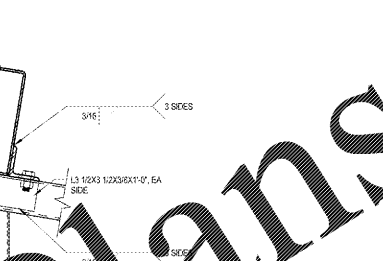

14 HIGH HSS TO HSS CONNECTION
CS4 1'-0\"/>

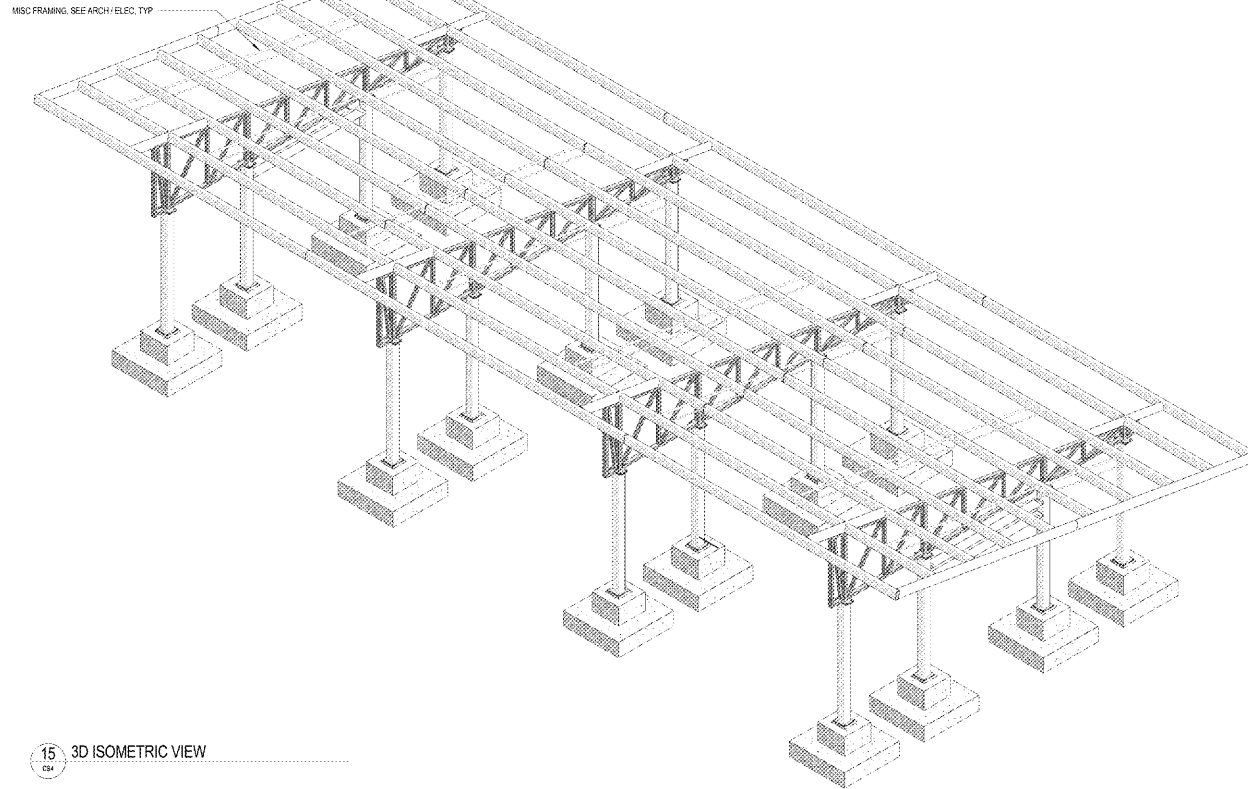

15 3D ISOMETRIC VIEW
CS4

Order Plans @

WAWA
Stacked 8 Gas Canopy 2018.01 Store #5275-LIT

WAWA
280 WEST BALTIMORE PIKE
HUDSON, PENNSYLVANIA 19053

PROJECT NAME
WAWA STACKED 8 GAS CANOPY 2018.01 STORE #5275-LIT
9021 STATE ROAD 62
HUDSON, FL 34689

PROJECT NO.	2101002	
DATE	03-24-2017	
BY	BRUNNEN	
CHECKED	JL	
REVISIONS		
No.	DESCRIPTION	DATE
1	PRELIMINARY	01/27/2017
2	REVISED	08/29/2018
3	REVISED	09/18/2018
4	REVISED	09/18/2018

CS4