

6 RESTROOM SIGNAGE
ACI 7 12\"/>

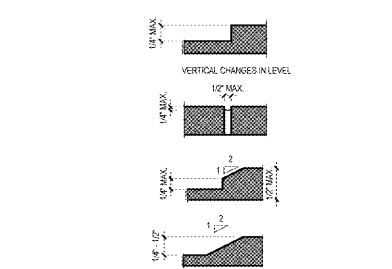

5 CHANGES IN LEVEL
ACI 11\"/>

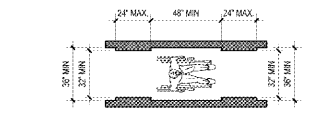

4 CLEAR WIDTH - ACCESSIBLE ROUTE
ACI 12\"/>

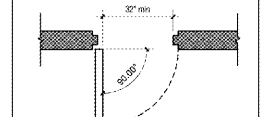

3 CLEAR WIDTH HINGED DOOR
ACI 12\"/>

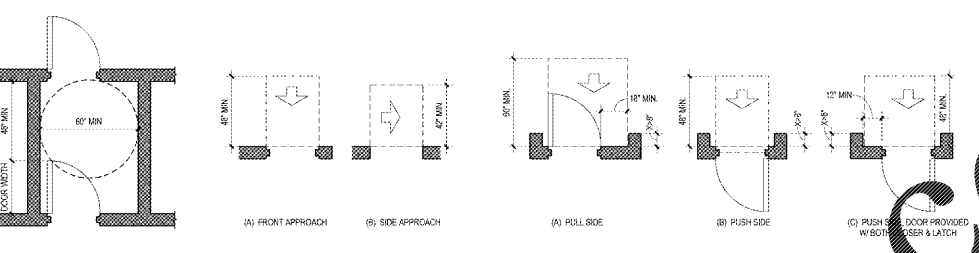

8 MANEUVERING CLEARANCE AT DOORS AND DOORWAYS
ACI 12\"/>

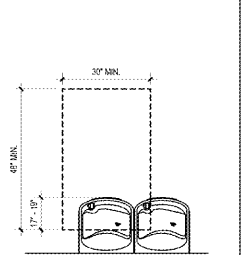

1 DRINKING FOUNTAIN PLAN
ACI 12\"/>

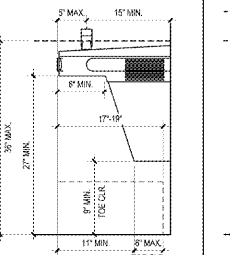

11 DRINKING FOUNTAIN SECTION
ACI 12\"/>

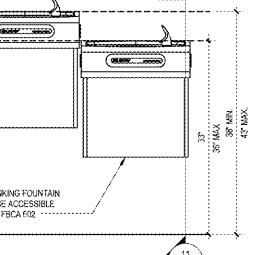

10 DRINKING FOUNTAIN ELEVATION
ACI 12\"/>

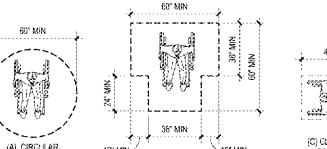

9 CLEAR TURNING SPACE
ACI 12\"/>

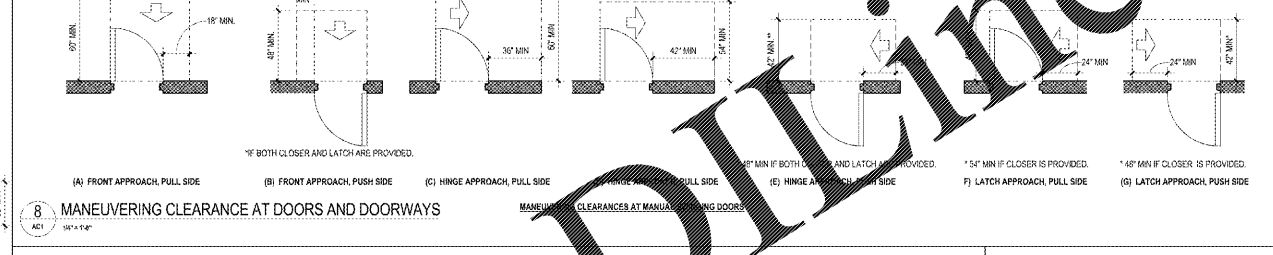

8 MANEUVERING CLEARANCE AT DOORS AND DOORWAYS
ACI 12\"/>

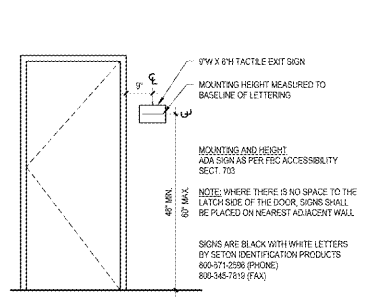

18 TACTILE EXIT SIGNAGE MOUNTING
ACI 12\"/>

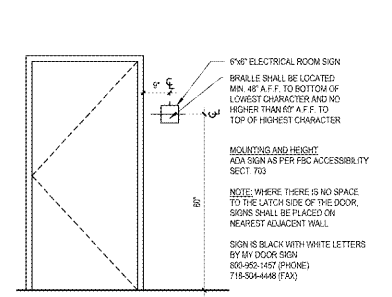

17 SIGNAGE MOUNTING HEIGHT
ACI 12\"/>

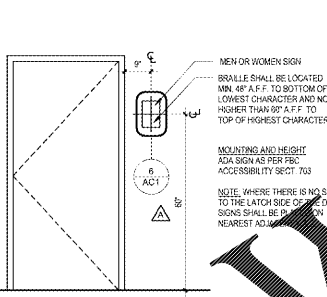

16 MEN OR WOMEN SIGN
ACI 12\"/>

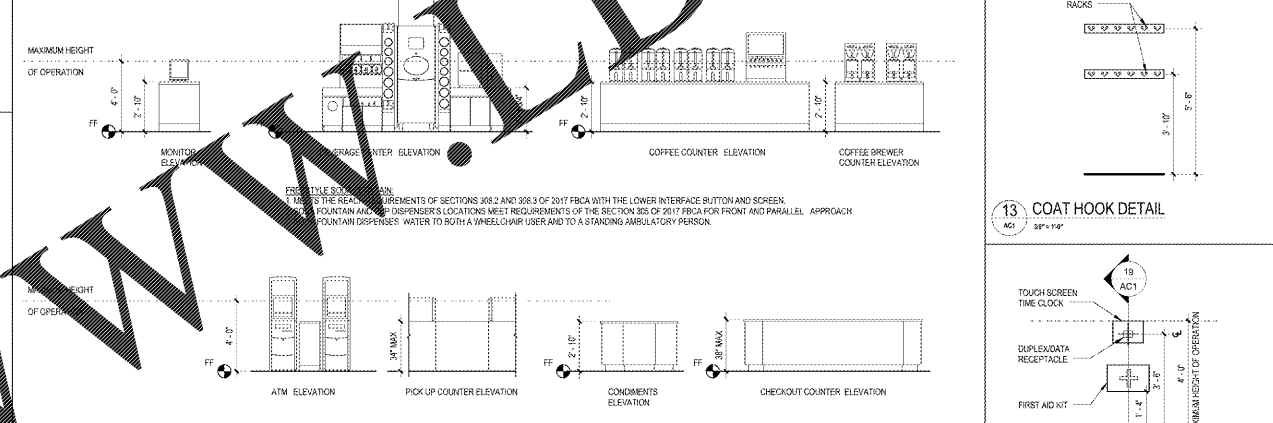

15 EQUIPMENT & COUNTERS ELEVATIONS
ACI 12\"/>

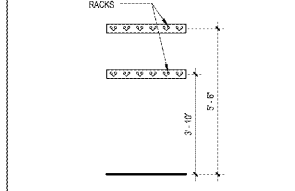

13 COAT HOOK DETAIL
ACI 12\"/>

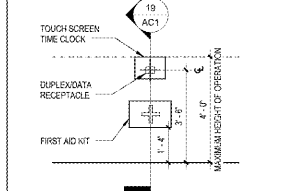

14 TIME CLOCK DETAIL
ACI 12\"/>

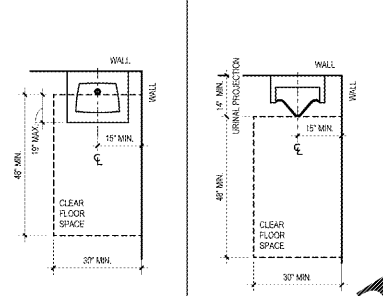

24 ACCESSIBLE LAV. PLAN
ACI 12\"/>

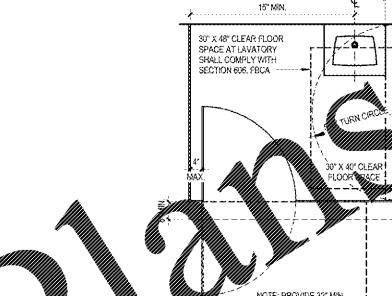

23 ACCESSIBLE URN. PLAN
ACI 12\"/>

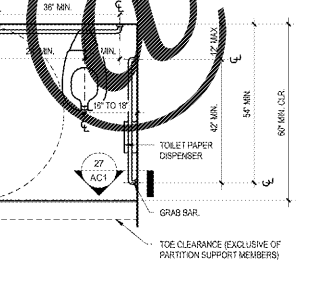

22 ACCESSIBLE WATER CLOSET - PLAN
ACI 12\"/>

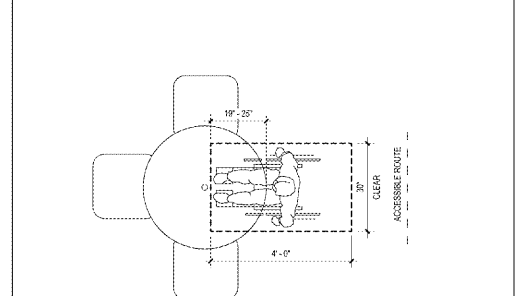

21 SEATING CLEARANCES
ACI 12\"/>

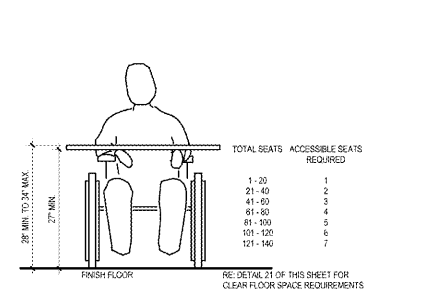

20 SEATING CLEARANCE - FRONT
ACI 12\"/>

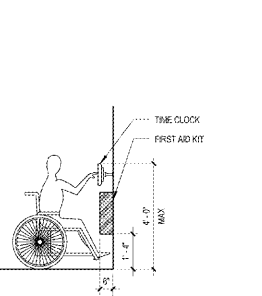

19 TIME CLOCK ACCESSIBLE REACH
ACI 12\"/>

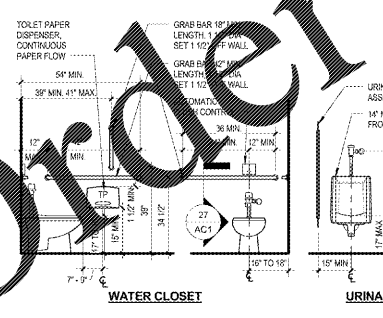

30 ACCESSIBILITY - RESTROOMS BARRIER FREE ELEVATIONS
ACI 12\"/>

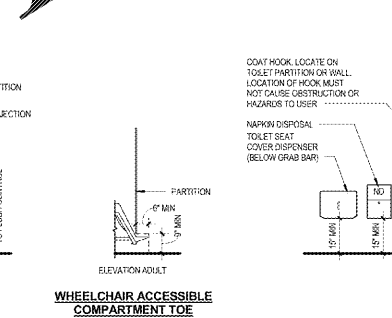

29 WHEELCHAIR ACCESSIBLE COMPARTMENT TOE CLEARANCE
ACI 12\"/>

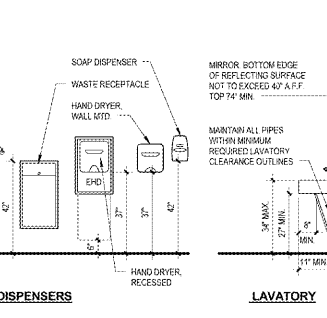

28 DISPENSERS
ACI 12\"/>

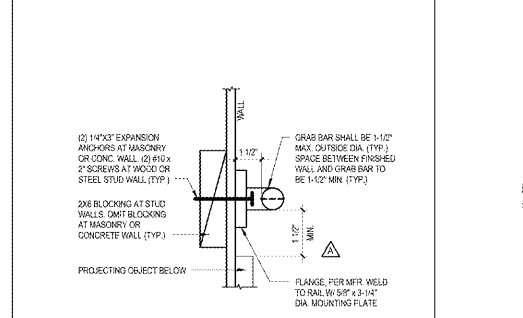

27 GRAB BAR DETAIL
ACI 12\"/>

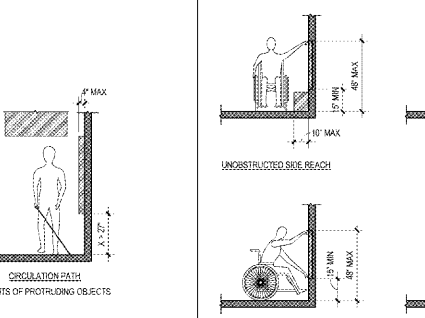

26 PROTRUDING OBJECTS
ACI 12\"/>

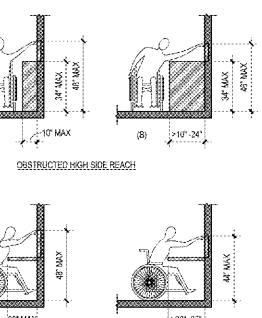

25 ACCESSIBLE REACH
ACI 12\"/>