

PROJECT NO.	2101002	DATE	03/27/2017
PREPARED BY	DAVID J. PETERSON	DATE	03/27/2017
DESIGNED BY	DAVID J. PETERSON	DATE	03/27/2017
CHECKED BY	DAVID J. PETERSON	DATE	03/27/2017
APPROVED BY	DAVID J. PETERSON	DATE	03/27/2017

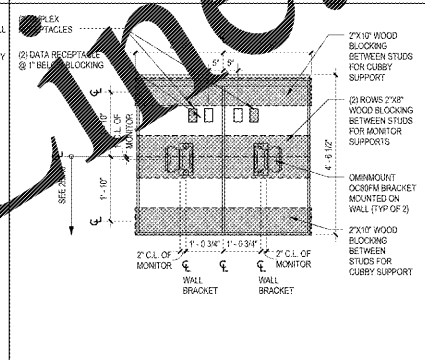
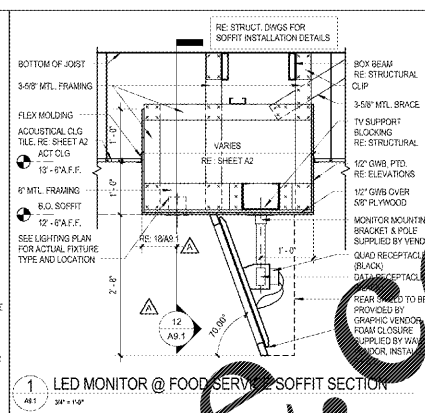
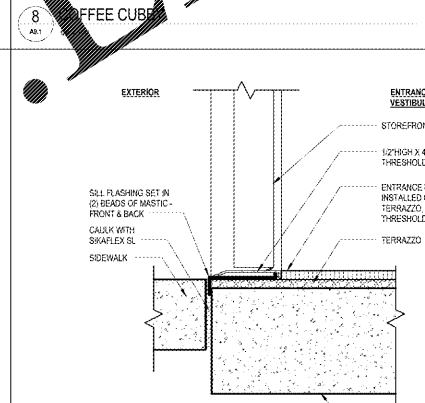
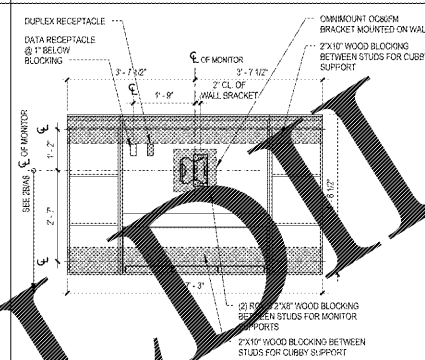
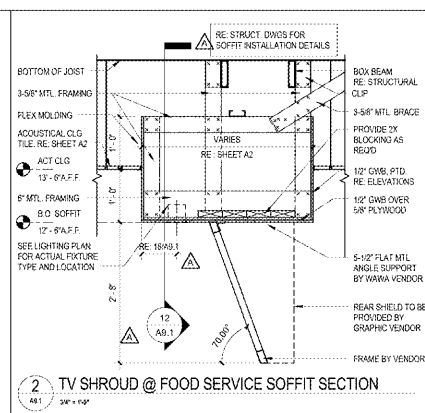
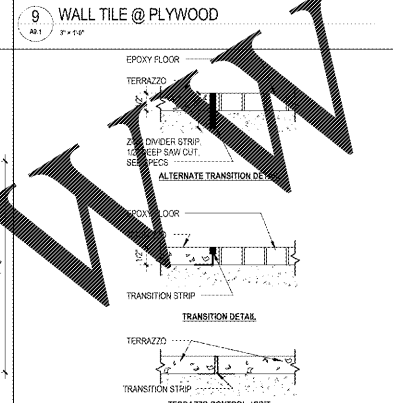
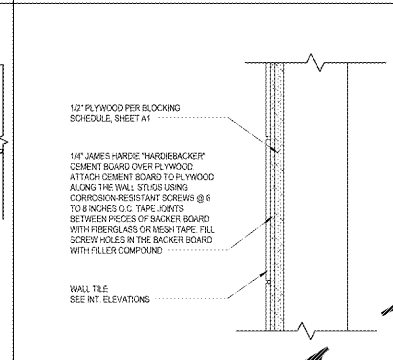
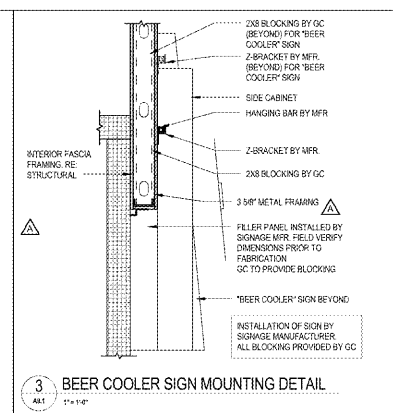
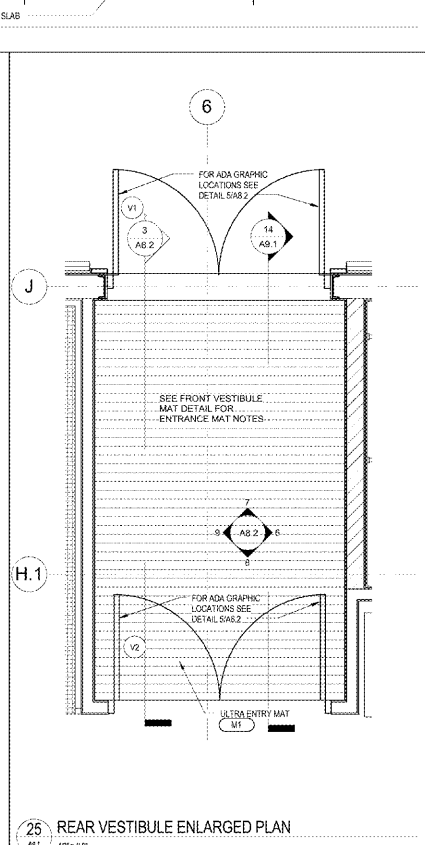
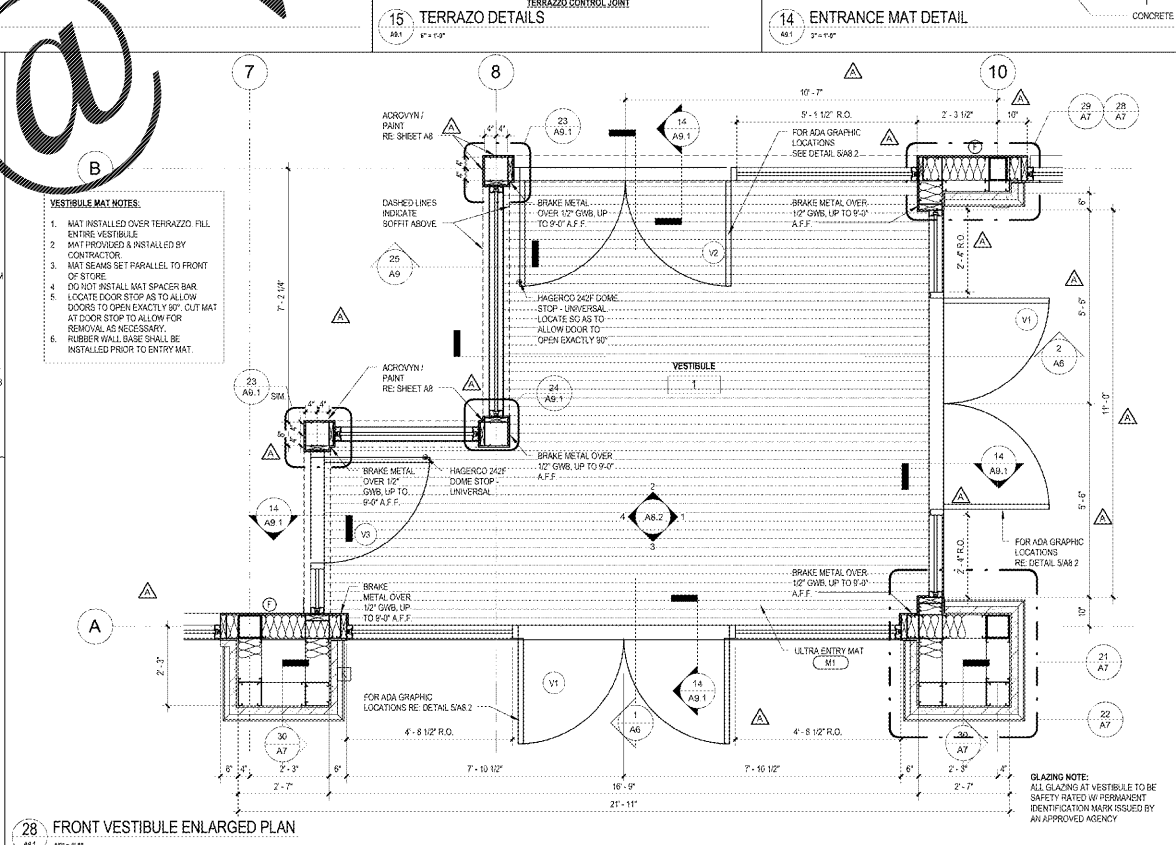
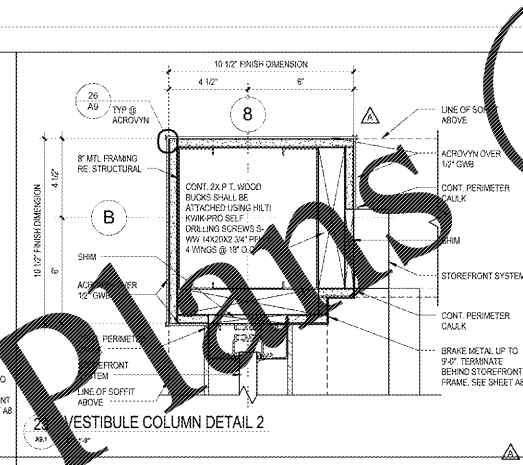
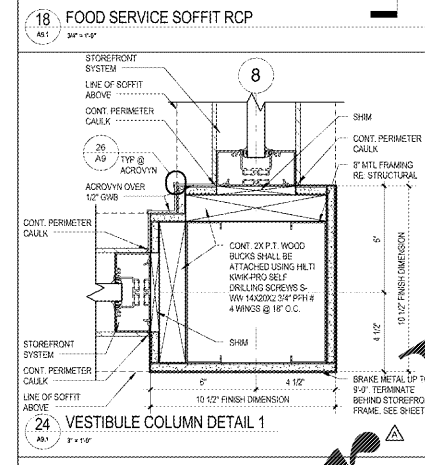
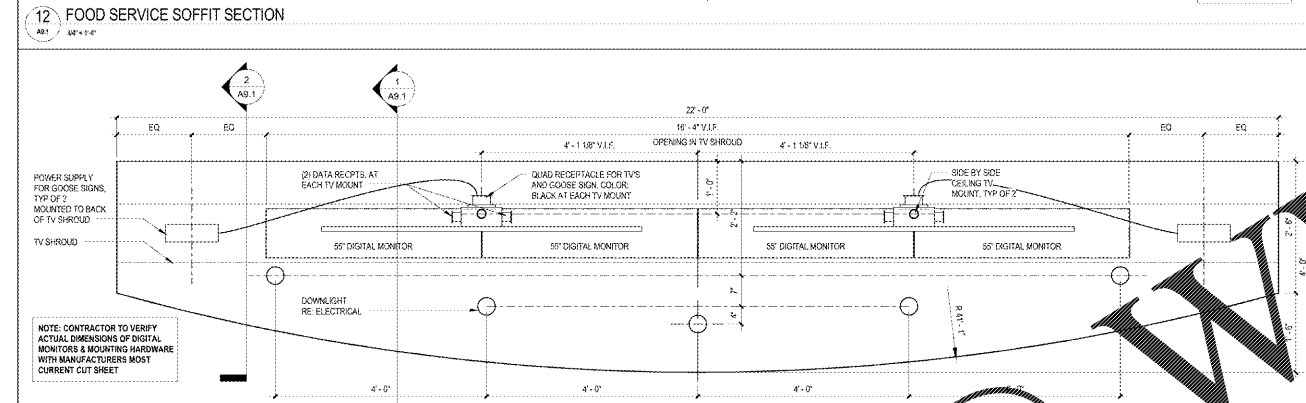
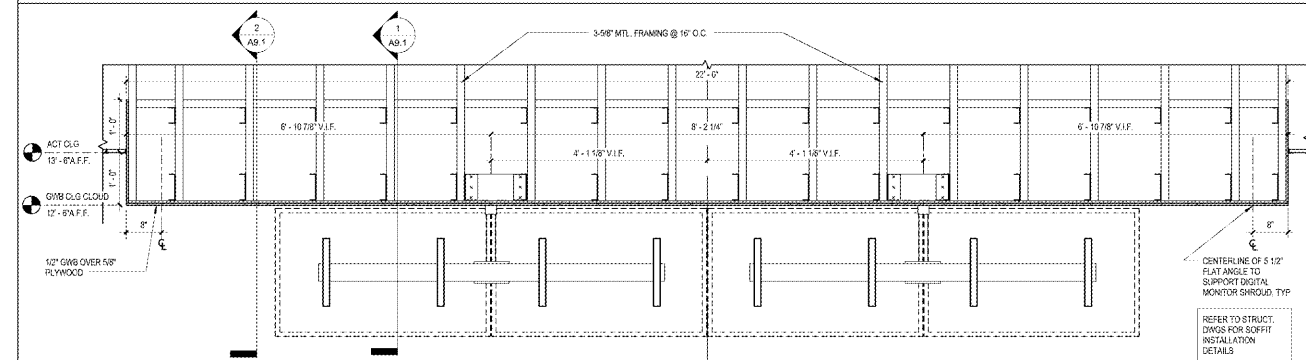
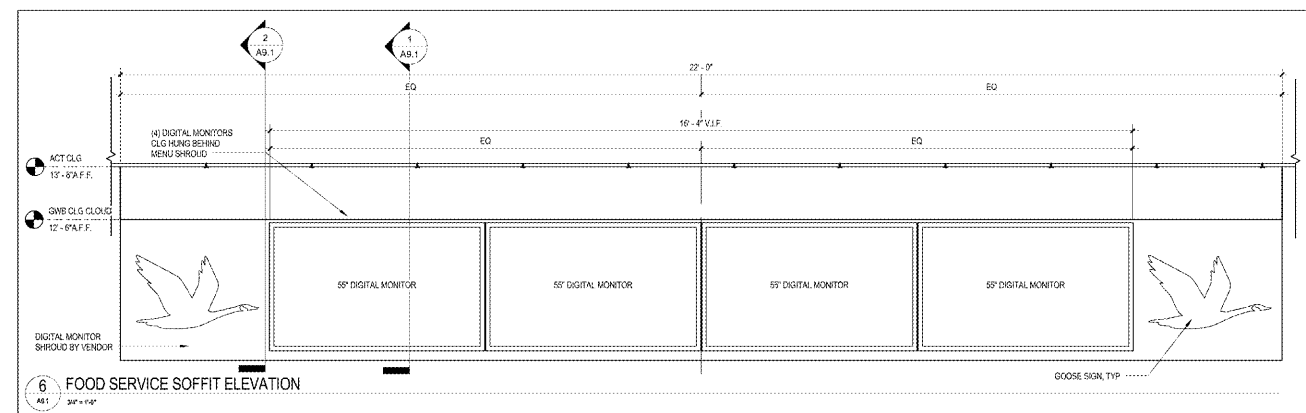

Order Plans @

WWW.IDLINE.COM