

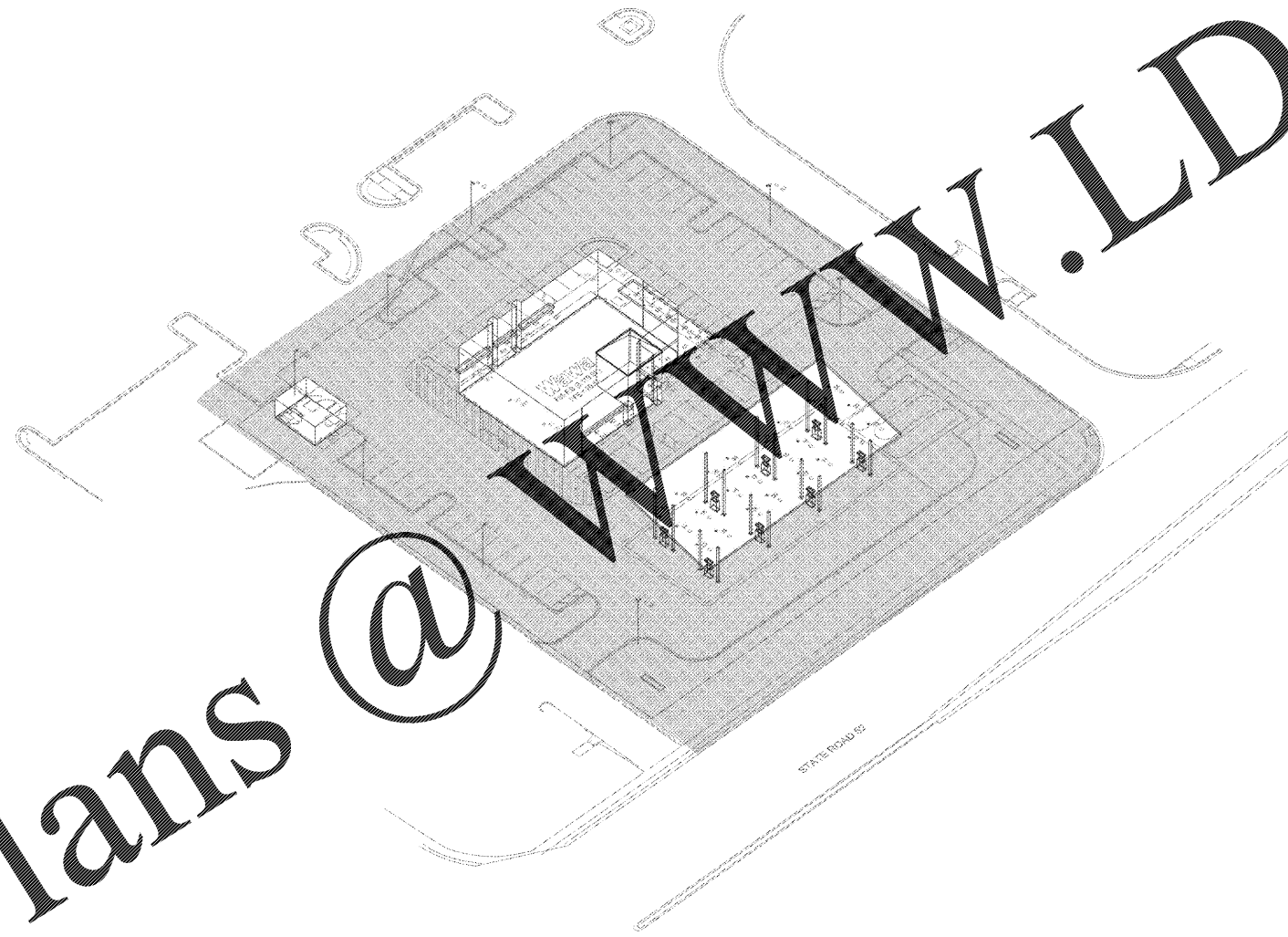

RL-4478-S1

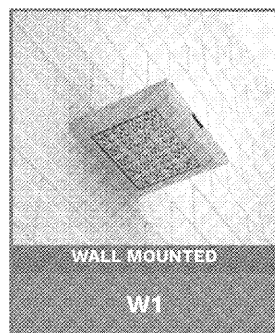
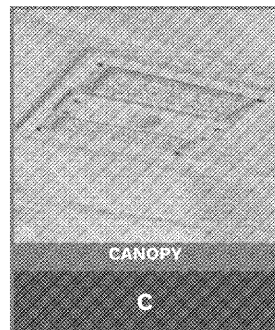
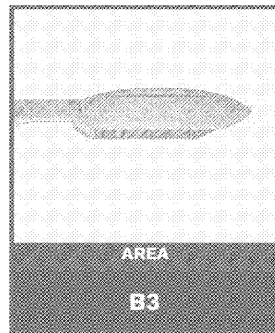
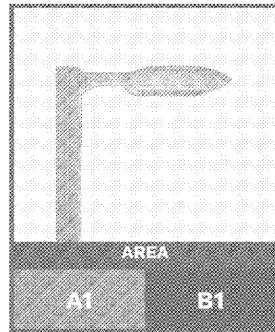

**SLOPE ADAPTER INTEGRATION PLATE MOUNT
FOR USE WITH 9 DEGREE SLOPE ADAPTER (BY OTHERS)
ALLOWS MOUNTING OF 304 SERIES LUMNAIRES**

FEATURES:

- POWDER COATED FINISH
- WITH 9 DEGREE SLOPE ADAPTER
- WITH POWER COORD BRASS
- MOUNTS TO EXISTING SLOPE ADAPTER
- 304 STAINLESS STEEL
- SPECIALLY DESIGNED FOR 304 SERIES LUMNAIRES. LIMITS FUTURE OPERATIONAL CLEARANCE TO 304 OR 304A. 700MA OPERATIONAL CLEARANCE IS 1.5" FROM FUTURE MOUNTING SURFACE WITH 1/2" SLOPE ADAPTER AND 1/2" CLEARANCE FROM SURFACE.
- FUTURE IS UL LISTED FOR WEATHER LOCATIONS
- SEE LUMINAIRE SPEC SHEET FOR FULL FEATURE DETAILS

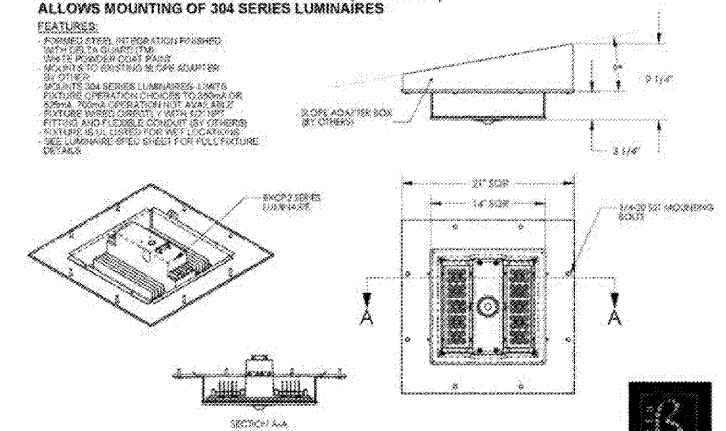

ALL DIMENSIONS ARE SUBJECT TO CHANGE
SEE THE PRODUCT DRAWING FOR COMPLETE DETAILS
FOR PHYSICAL DIMENSIONS PLEASE VISIT www.LDILine.com

ENC10-0001



CLICK OR SCAN HERE FOR
INTERIOR OPTIONS

3D CONTENT QUICK HELP GUIDE

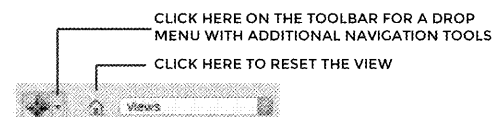

**CLICK THE IMAGE TO ACTIVATE THE
3D CONTENT / RIGHT CLICK TO DISABLE**