

1 Roof Drain Detail
SCALE: 1 1/2" = 1'-0"

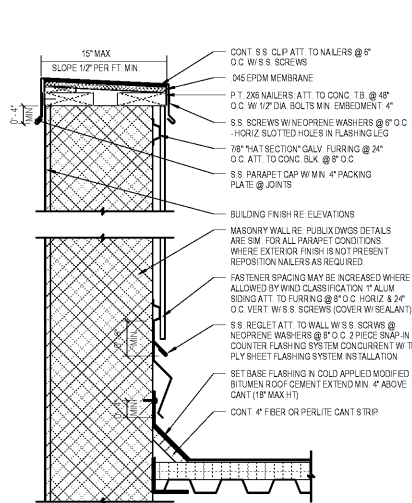

2 Parapet Detail
SCALE: 3/4" = 1'-0"

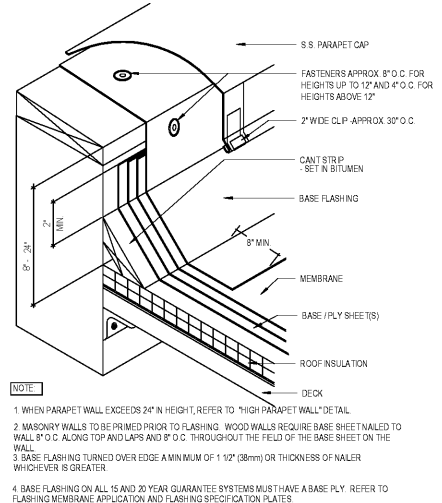

3 Low Wall Flashing Detail
SCALE: 1 1/2" = 1'-0"

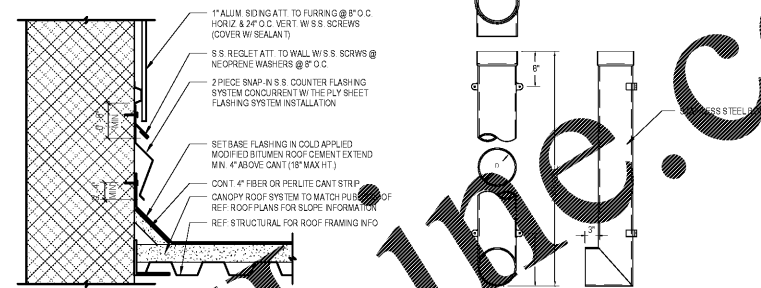

4 Cant Strip Detail
SCALE: 3/4" = 1'-0"

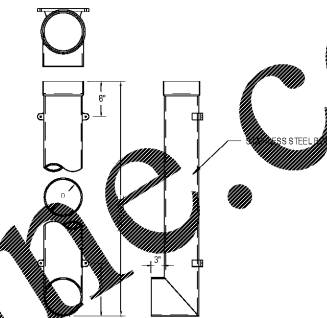

5 Downspout Boot Detail
SCALE: 12" = 1'-0"

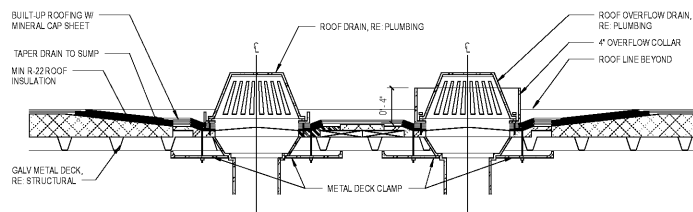

6 Roof Drain & Overflow Assembly 1
SCALE: 1 1/2" = 1'-0"

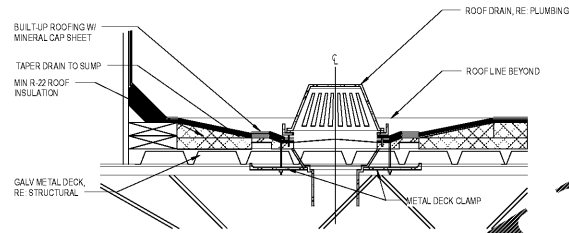

7 Roof Drain & Overflow Assembly 2
SCALE: 1 1/2" = 1'-0"

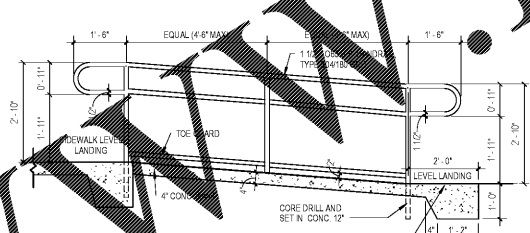

8 Handicapped Ramp - Detail
SCALE: 1 1/2" = 1'-0"

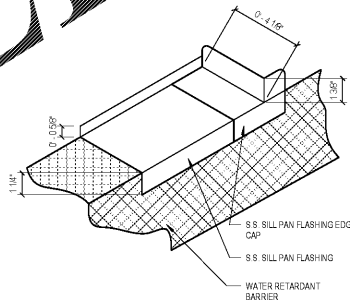

9 Sill Pan Flashing Detail
SCALE: 3" = 1'-0"

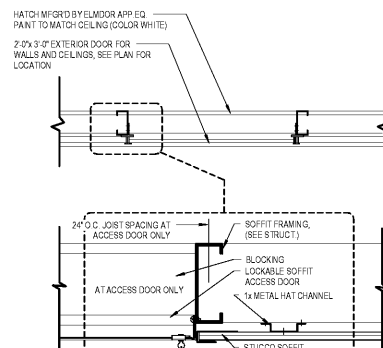

10 Access Hatch & Lock Detail
SCALE: 1 1/2" = 1'-0"

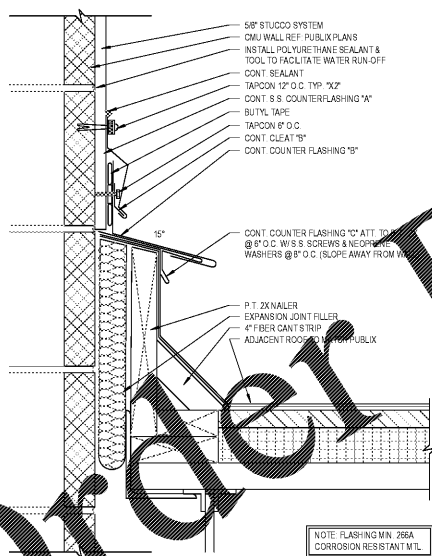

11 Expansion Joint Detail
SCALE: 3" = 1'-0"

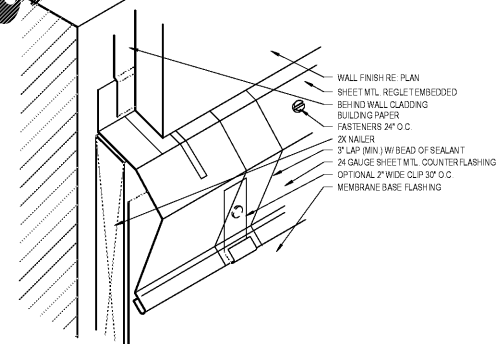

12 Flashing Detail
SCALE: 3/4" = 1'-0"

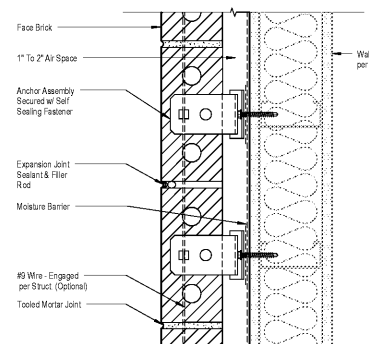

13 Brick Veneer on Stud (Plan)
SCALE: 3" = 1'-0"

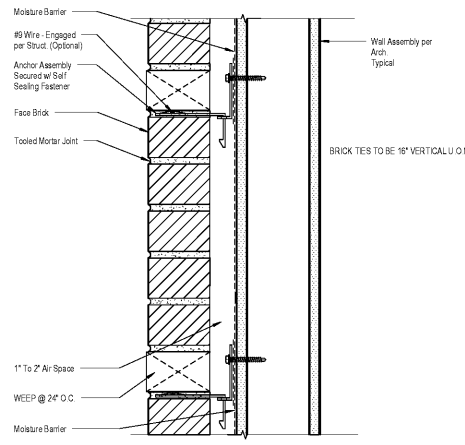

14 Veneer w/ Steel Stud @ Wall
SCALE: 3" = 1'-0"

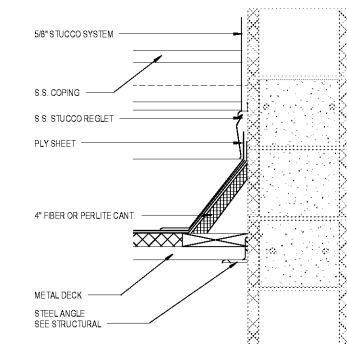

15 Parapet Roof Flashing Detail
SCALE: 1 1/2" = 1'-0"

Order Plans @

WWW.LDLINE.COM

1925 PROSPECT AVE
Orlando, FL 32814
P (407) 661-9100
F (407) 661-9101
www.ldline.com

Calaci & Ret...
Architects Engineers

White Development Company
1801 South Keene Road
Clearwater, Florida 33756

Publix @ Tattersall Park
NEC of U.S. Highway 280 & Highway 119
Hoover, Alabama

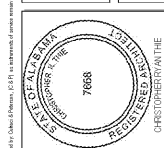

Revision Schedule	
No.	Date
A	04/07/18
B	07/25/18
C	07/26/18
D	7/26/18

PCA402