

1 Cornice Profile 'A'
SCALE: 1" = 1'-0"

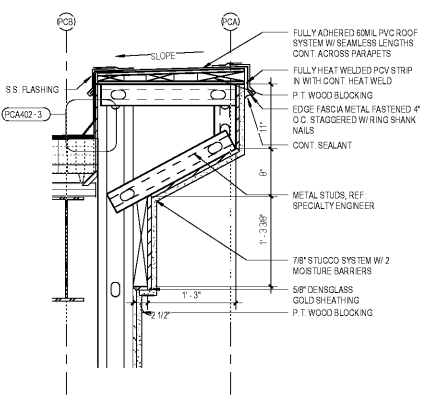

2 Cornice Profile 'B'
SCALE: 1" = 1'-0"

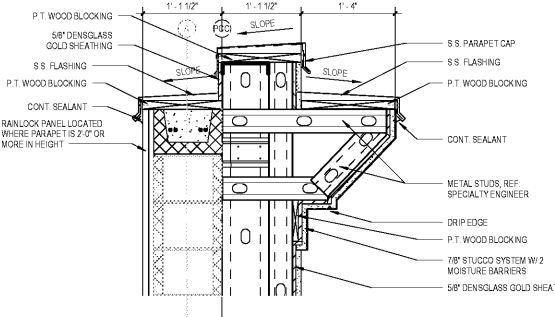

3 Cornice Profile 'C'
SCALE: 1" = 1'-0"

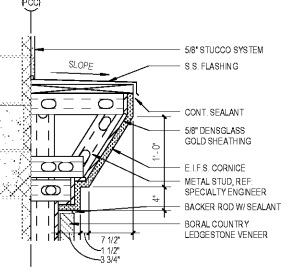

4 Cornice Profile 'D'
SCALE: 1" = 1'-0"

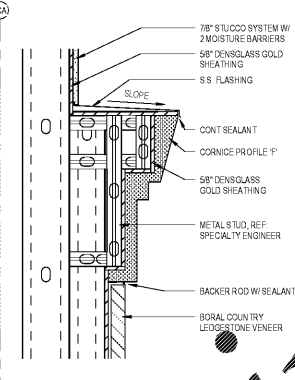

5 Cornice Profile 'F'
SCALE: 1" = 1'-0"

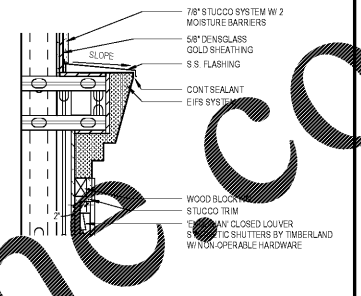

6 Cornice Profile 'G'
SCALE: 1" = 1'-0"

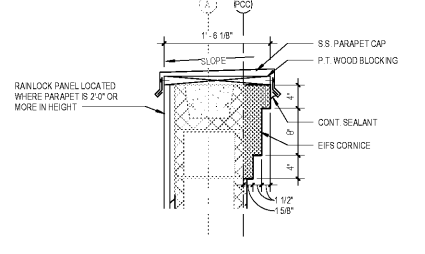

7 Cornice Profile 'H'
SCALE: 1" = 1'-0"

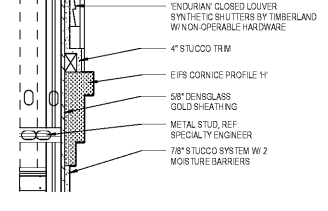

8 Trim Detail
SCALE: 1" = 1'-0"

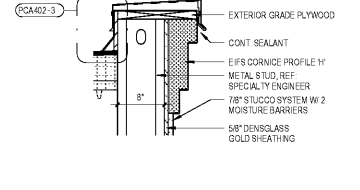

9 Parapet Detail
SCALE: 1" = 1'-0"

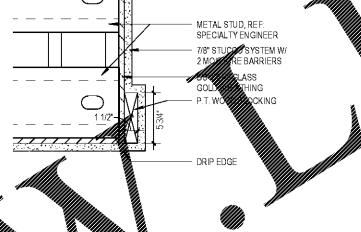

10 Trim Detail
SCALE: 1 1/2" = 1'-0"

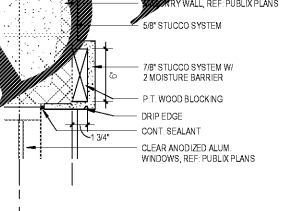

11 Trim Detail
SCALE: 1 1/2" = 1'-0"

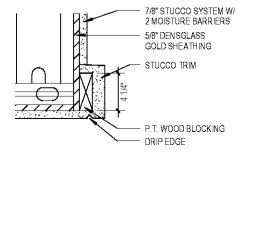

12 Trim Detail
SCALE: 1 1/2" = 1'-0"

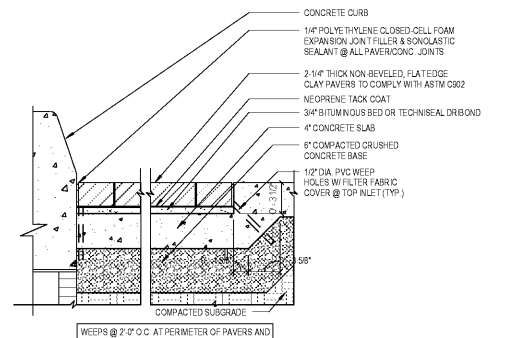

13 Paver Detail
SCALE: 1 1/2" = 1'-0"

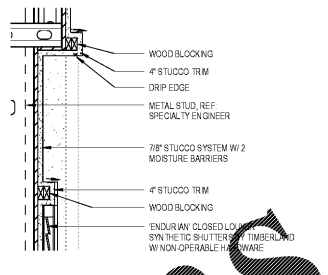

14 Trim Detail
SCALE: 1" = 1'-0"

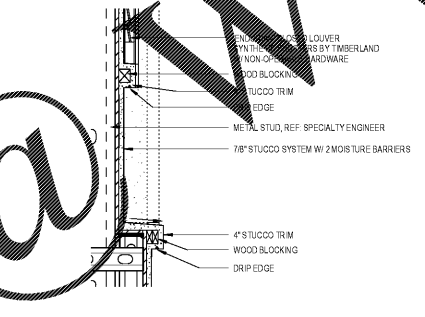

15 Trim Detail
SCALE: 1" = 1'-0"

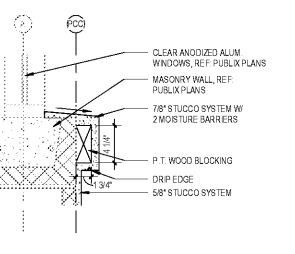

16 Trim Detail
SCALE: 1 1/2" = 1'-0"

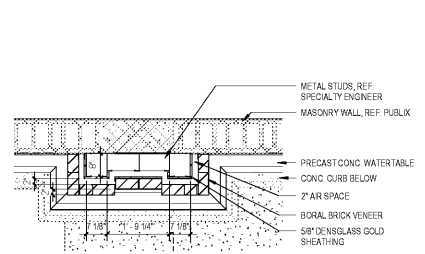

22 Pilaster at 4'-0"
SCALE: 1/2" = 1'-0"

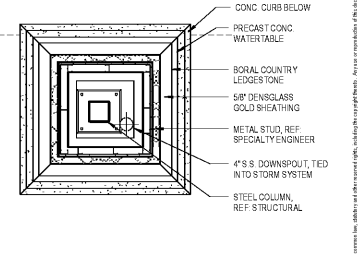

24 Column at 6'-0"
SCALE: 1/2" = 1'-0"

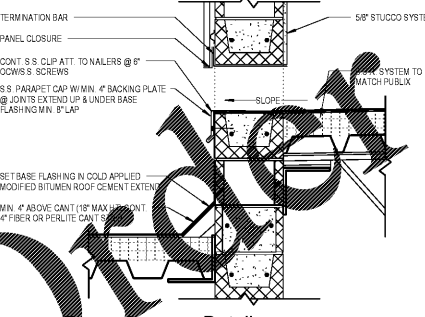

17 Lower Scupper Detail
SCALE: 1" = 1'-0"

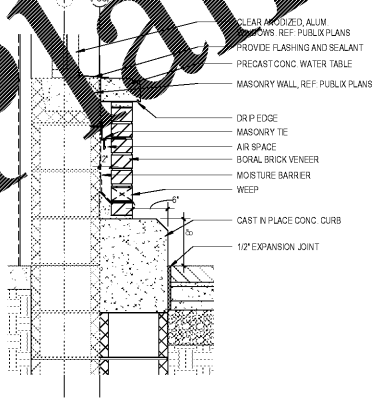

18 Base Detail
SCALE: 1" = 1'-0"

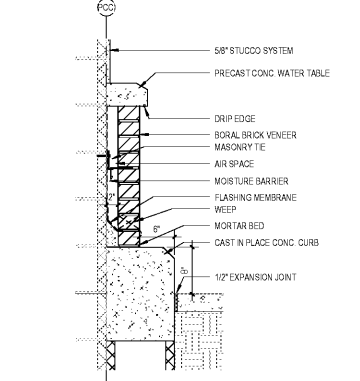

19 Base Detail
SCALE: 1" = 1'-0"

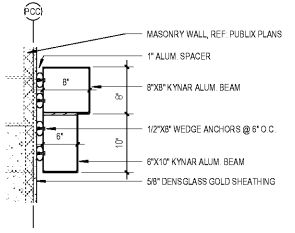

20 Kynar Double Beam Profile
SCALE: 1" = 1'-0"

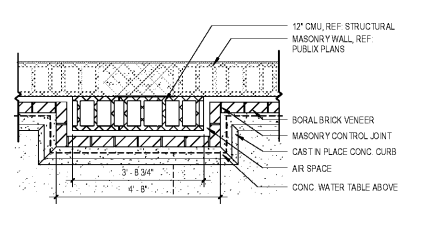

21 Pilaster at 2'-0"
SCALE: 1/2" = 1'-0"

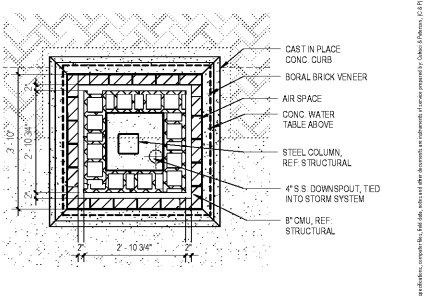

23 Column at 2'-0"
SCALE: 1/2" = 1'-0"

Order Plans

WWW.LDLINE.COM

1925 Prospect Ave.
Orlando, FL 32814
P (407) 661-9100
F (407) 661-9101
www.ldline.com

White Development Company
1801 South Keene Road
Clearwater, Florida 33766

Publix @ Tattersall Park
NEC of U.S. Highway 280 & Highway 119
Hoover, Alabama

Architectural Details



No.	Description	Date
B	100% Public Submission	04/07/18
C	Re-submission	07/06/18
D	Issue to Bid & Permit	7/26/18

PCA401