

LIGHT FIXTURE SCHEDULE																	
ALL ITEMS LISTED ON THE "LIGHT FIXTURE SCHEDULE" WILL BE SUPPLIED BY THE OWNER (O'REILLY). ITEMS SHALL BE DIRECT ORDERED AND/OR RELEASED FROM THE LISTED ELECTRICAL EQUIPMENT DISTRIBUTOR.																	
GRAYBAR ELECTRIC CO., INC. 11885 LACKLAND ROAD ST. LOUIS, MO 63146																	
GRAYBAR O'REILLY TEAM EMAIL: oreilly@graybar.com TOLL FREE: (314) 573-2080																	
MARK	MFR.	CATALOG NUMBER	SUPPLY VOLTAGE	FINISH	MOUNTING				LAMPS				WATTAGE	DESCRIPTION OF ACCESSORIES	NOTES	FIXTURE QUANTITY	
					LAY-IN	RECESSED	SURFACE WALL	SURF. CEILING	OTHER	FLUORESCENT	LED	OTHER					(General Electric) LAMP CATALOG NUMBER/TYPE
LED DIMMABLE LIGHTS - ALL INDOOR LIGHT FIXTURES SHALL HAVE DISCONNECTING MEANS TO COMPLY WITH NEC 410.150(G)																	
A	LSI	SDL 8 LED 78 40 UE OR NO SUBSTITUTIONS	120	WHITE			X		X				67	GRID HANGER (2 PER FIXTURE)	GRID HANGER (648480) (CEILING GRID ONLY), 0-10 VOLT DIMMING DRIVER STANDARD	52	
B	LSI	SDL 4 LED 39 40 UE OR NO SUBSTITUTIONS	120	WHITE			X		X				34	GRID HANGER (2 PER FIXTURE)	GRID HANGER (648480) (CEILING GRID ONLY), 0-10 VOLT DIMMING DRIVER STANDARD, OMIT GRID HANGER @ HARD CEILING	14	
C	LSI	SDL 8 LED 78 40 UE OR NO SUBSTITUTIONS	120	WHITE			X		X				67	3' CHAIN HANGING KIT (1 PER FIXTURE)	HANG TOP OF FIXTURES AT 12' A.F.F. WITH CHAIN HANGERS AND LENGTH OF CHAIN AS REQUIRED, 0-10 VOLT DIMMING DRIVER STANDARD	32	
D	LSI	SDL 4 LED 39 40 UE OR NO SUBSTITUTIONS	120	WHITE			X		X				34	3' CHAIN HANGING KIT (1 PER FIXTURE)	HANG TOP OF FIXTURES AT 12' A.F.F. WITH CHAIN HANGERS AND LENGTH OF CHAIN AS REQUIRED, 0-10 VOLT DIMMING DRIVER STANDARD	11	
COMBINATION EXIT/EMERGENCY LIGHTS, EMERGENCY LIGHTS & EXTERIOR EMERGENCY REMOTE HEADS																	
XR	COOPER	APCH7R (RED LETTERS)	120	WHITE		X	X		X			2	LED EXIT + (2) 3.6V	2.34	UNIVERSAL (WALL/CLG.) SINGLE PR DOUBLE FACE	BACKUP BATTERIES SHALL MAINTAIN 100% ILLUMINATION FOR A MINIMUM OF 90 MINUTES TO COMPLY WITH ARTICLE 700.12(A) OF THE N.E.C.	8
EM	COOPER	APEL	120	WHITE		X	X		X			2	3.6V	0.33	UNIVERSAL (WALL/CLG.)	BACKUP BATTERIES SHALL MAINTAIN 100% ILLUMINATION FOR A MINIMUM OF 90 MINUTES TO COMPLY WITH ARTICLE 700.12(A) OF THE N.E.C.	17
RM2	COOPER	APWR2	3.6V DC	WHITE		X			X			2	LED REMOTE HEAD	0	----	POWERED BY EMERGENCY "XR" FIXTURE.	3
LED EXTERIOR LIGHTS																	
PC	INTERMATIC	PHOTOCELL -- #K4251	120	DARK BRONZE		X										MOUNT ABOVE WALL PACK LOCATED NEAR FREIGHT DOOR.	1
L	LSI	LAD6 41 LED 40 75 UE TR6R SFHAZ	120	CLEAR	X				X			1				RECESSED CAN.	1
WGX	SEE "SP1" SHEET FOR EXTERIOR LIGHTING WALL SCONCE FIXTURE SCHEDULE																
PX	SEE "SP1" SHEET FOR EXTERIOR LIGHTING POLE LIGHT FIXTURE SCHEDULE																
FIXTURE QUANTITY TO BE VERIFIED WITH LIGHTING PLAN QUANTITY																	

- ### LIGHTING - KEYNOTES
- MOUNT J-BOX INSIDE BUILDING & FLEX CONDUIT THRU WALL FOR POWER SUPPLY TO ILLUMINATED SIGN. EXACT LOCATIONS OF PENETRATIONS SHALL BE COORDINATED WITH SIGN COMPANY. PENETRATIONS SHALL BE BEHIND SIGNAGE. WATERPROOF W/ ELASTOMERIC POLYURETHANE (NO EXCEPTIONS) EQUAL TO "VULKEN" 118. WIRE TO SIGN WITH 15' OF WIRING "WHIP" (SHALL BE FLEX OR TYPE MC CABLE). COIL AND "CABLE TIE" WIRING "WHIP" TO WALL ABOVE CEILING. TYPICAL.
 - TO "OPEN" SIGN. SEE SHEET E2.
 - SEE "E" PANEL TRANSFER SWITCH SCHEDULE FOR POSITION OF CIRCUIT WIRES THROUGH TRANSFER SWITCH.
 - VIA VENSTAR SURVEYOR / LIGHTING CONTROL PANEL. SEE SHEET V51 & VENSTAR SCOPE OF WORK (S.O.W.).
 - MOUNT 8'-0" A.F.F. TO BACK OF HEADER WALL. THESE FIXTURES ONLY.
 - SUSPEND 8'-0" A.F.F. THIS FIXTURE ONLY.
 - ROUTE THE OFFICE AND RESTROOM'S LIGHTING CIRCUIT THRU THE LOCAL OCCUPANCY SENSORS AND DIRECTLY TO THE CIRCUIT BREAKER. THESE FIXTURES SHALL NOT BE SWITCHED BY THE LIGHTING CONTROL PANEL. SEE "E" PANEL TRANSFER SWITCH SCHEDULE FOR POSITION OF CIRCUIT WIRES THROUGH TRANSFER SWITCH.
 - REFER TO ARCHITECTURAL ELEVATIONS SHEETS SHOWING DIMENSIONED LOCATIONS. TYPICAL ALL WALL SCONCE.
 - SECURITY & EGRESS FIXTURE TO BE AS CLOSE AS POSSIBLE BUT NOT OVER THE OVERHEAD DOOR WHEN OPEN.
 - ROUTE SECURITY & EGRESS LIGHTING CIRCUIT DIRECTLY TO THE ELECTRICAL PANEL.
 - DIMMER LIGHTING CONTROL SWITCHES LOCATED ON OUTSIDE WALL OF OFFICE. SEE LIGHTING PLAN FOR QUANTITY. SEE DETAILS ON SHEET E4 FOR MORE INFORMATION.

- ### AUTOMATIC LIGHTING CONTROL
- COMPLIANCE WITH ENERGY CODE IS ACHIEVED BY:
- ONCE THE EMS HAS BEEN PROGRAMMED, THE INTERIOR AND EXTERIOR LIGHTS WILL TURN ON AND OFF USING THE FOLLOWING LOGIC: SEE SHEETS V51, V52 AND V53
 - INTERIOR WORK LIGHTS WILL TURN ON WITH FIRST MOTION IN THE STORE AND WILL TURN OFF 15 MINUTES AFTER LAST MOTION ONCE THE STORE IS CLOSED.
 - INTERIOR SALES LIGHTS WILL TURN ON AT STORE OPENING AND TURN OFF 15 MINUTES AFTER STORE CLOSING.
 - EXTERIOR SIGN LIGHTS WILL TURN ON WHEN ITS DARK ENOUGH OUTSIDE ANYTIME DURING STORE HOURS, AND WILL TURN OFF AT STORE CLOSING.
 - EXTERIOR SITE LIGHTS WILL TURN ON WHEN IT IS DARK ENOUGH OUTSIDE AND IT IS WITHIN STORE HOURS OR THERE IS MOTION IN THE STORE. THEY WILL TURN OFF 30 MINUTES AFTER LAST MOTION ONCE THE STORE IS CLOSED.
- FOR NEW CONSTRUCTION LOCATIONS ONLY, THERE IS A TEMPORARY PROGRAM TO KEEP SIGN AND SITE LIGHTS ON UNTIL MIDNIGHT RATHER THAN THE TIMES INDICATED ABOVE. O'REILLY WILL DISABLE THIS PROGRAM ONE YEAR AFTER STORE OPENING.
2. RESTROOMS AND OFFICES: ALL LIGHTING IN THESE AREAS ARE CONTROLLED BY OCCUPANT-SENSING DEVICES.

- ### INTERIOR LIGHTING ZONES
- ALL INTERIOR LIGHTING WITHIN PARTS AREA "A" SHALL BE CONSIDERED "SALES" ZONE (ON ONLY WHEN STORE IS OPEN FOR BUSINESS).
- ALL INTERIOR LIGHTING WITHIN PARTS AREA "B" PARTS AREA "C", RESTROOMS, OFFICES AND BREAK AREA SHALL BE CONSIDERED "OFFICE" ZONES (WHENEVER THERE IS MOTION IN THE STORE OR OFFICE).

SEISMIC RESTRAINTS (ONLY REQUIRED FOR SEISMIC DESIGN CATEGORIES C,D,E,F)

CONTRACTOR TO REFER TO ARCHITECTURAL SHEET G1.1 FOR SEISMIC DESIGN CATEGORY.

IF REQUIRED SEE SEISMIC DETAILS SHEET ME1.

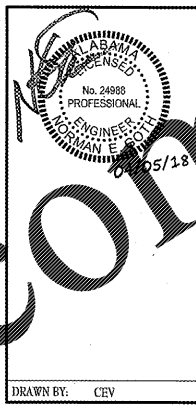
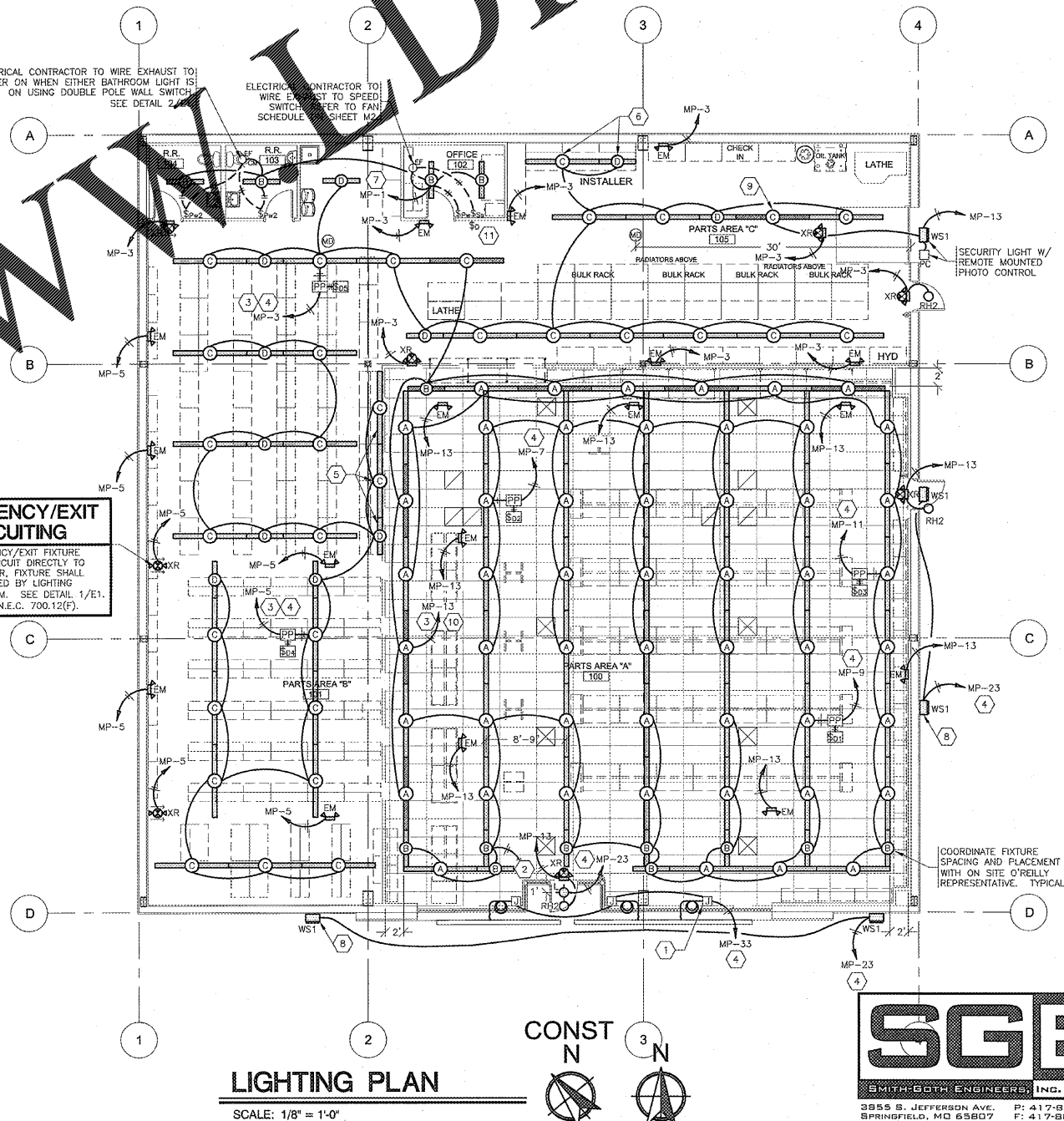
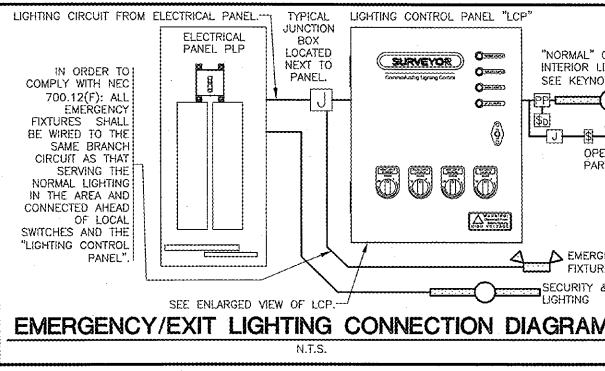
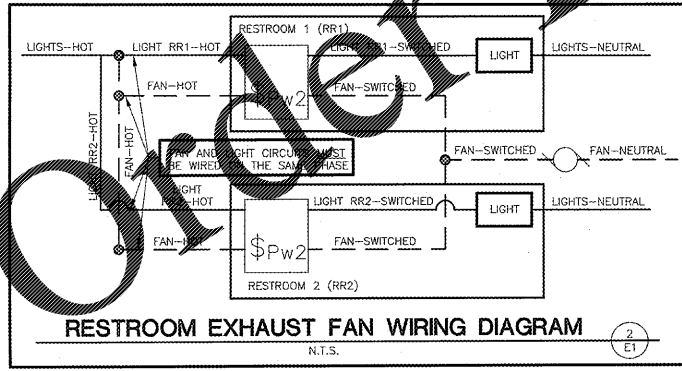
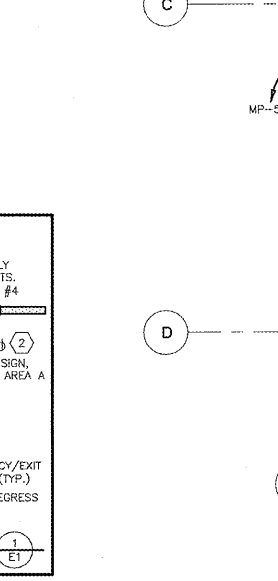
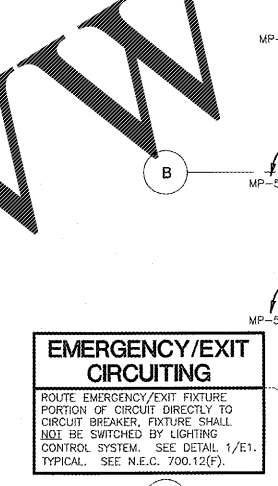
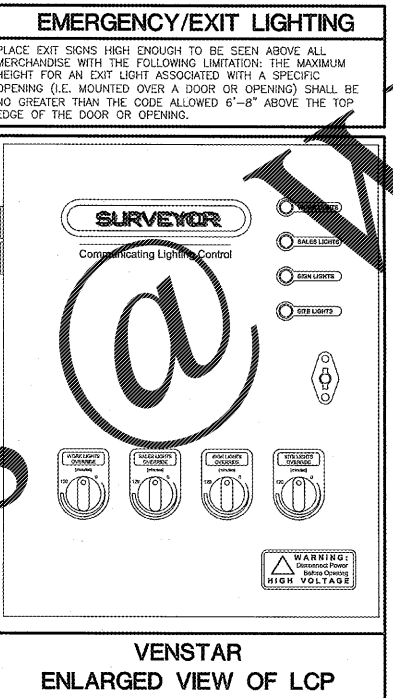
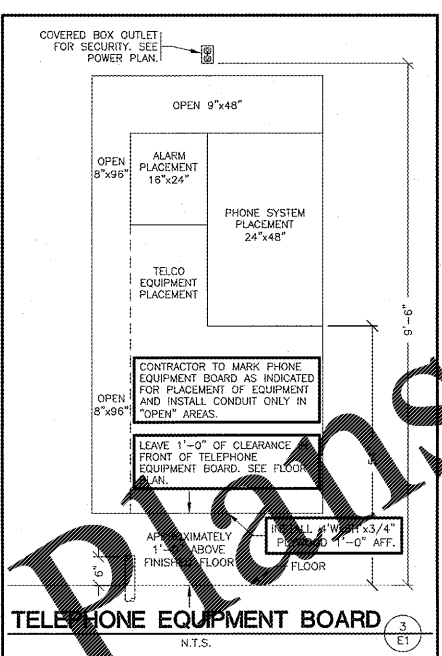
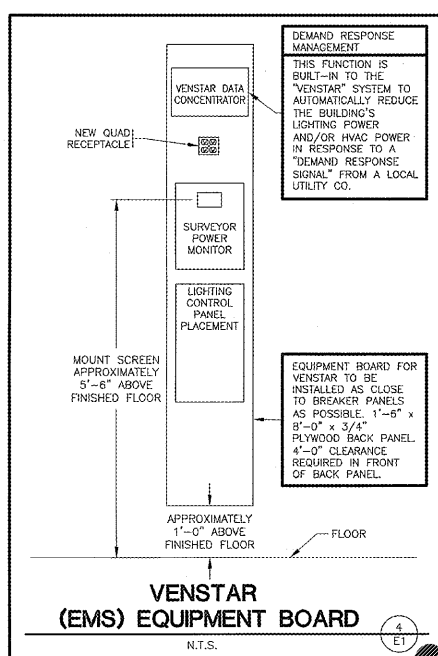

CRAIG A. SCHNEIDER, AIA
ARCHITECT

1736 East Sunshine, Suite 417
Springfield, Missouri 65804
Tel: 417.862.3265
Fax: 417.862.3265
E-mail: architect@esterlyschneider.com

PROJECT:
NEW O'REILLY AUTO PARTS STORE
HWY 67
PRICEVILLE, AL

O'Reilly AUTO PARTS
CORPORATE OFFICES
233 SOUTH PATTERSON
SPRINGFIELD, MISSOURI 65802
(417) 862-2674 TELEPHONE

COMM # 4160
DATE: 04-06-18
REVISION
DATE:

