

Order Plans @ www.plumbing.com

PLUMBING CALCULATIONS							
FIXTURE	QUANTITY	TOTAL-SFU	TOTAL	TOTAL-HW	TOTAL	DFU	TOTAL
W.C. (TANK)	2	5	10	0	0	4	8
URN. (URINAL)	1	5	5	0	0	4	4
LAV. (LAVATORY)	2	2	4	1.5	3.00	2	4
M.B. (MOP BASIN)	1	3	3	1.5	1.50	2	2
H.D.F. (FOUNTAIN)	1	0.25	0.25	0	0	0.5	0.50
H.B. (HOSE BIBB)	2	3	6	0	0	0	0
TOTAL		28.25	TOTAL	4.50	TOTAL	18.50	
TOTAL CW GPM	20		AVERAGE DAILY FLOW = 125 gal/Day				
COLD WATER SERVICE SIZE	1"						

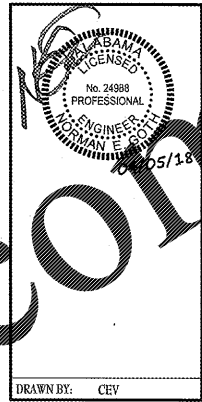
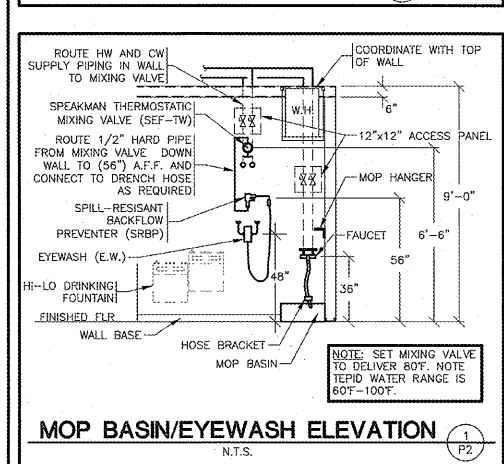
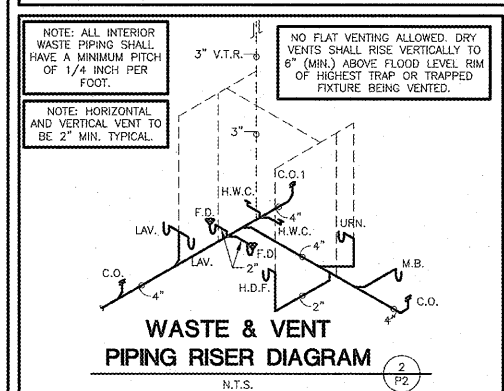
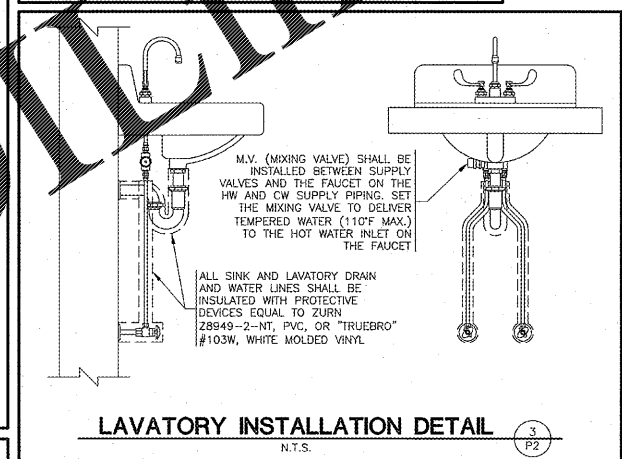
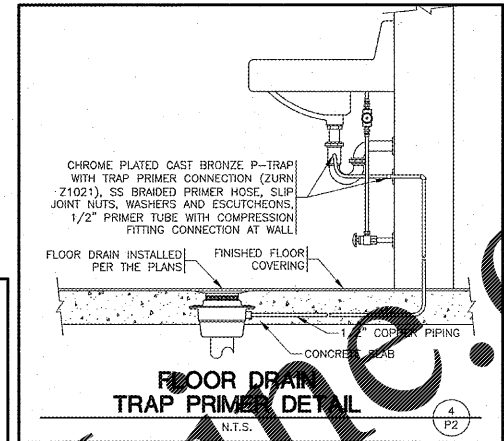
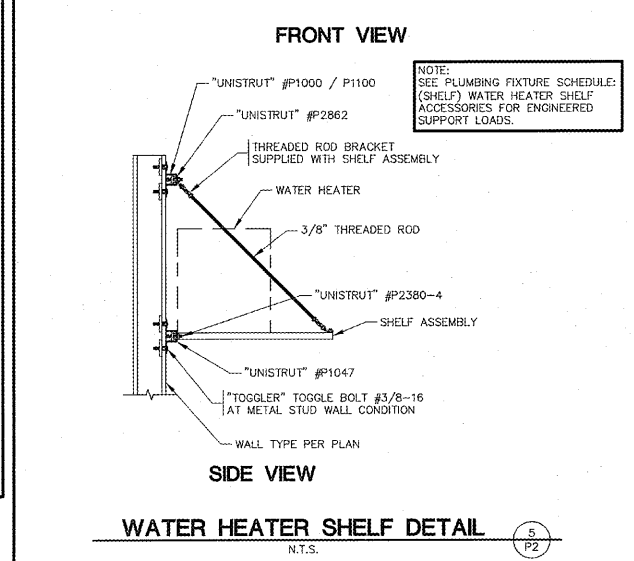
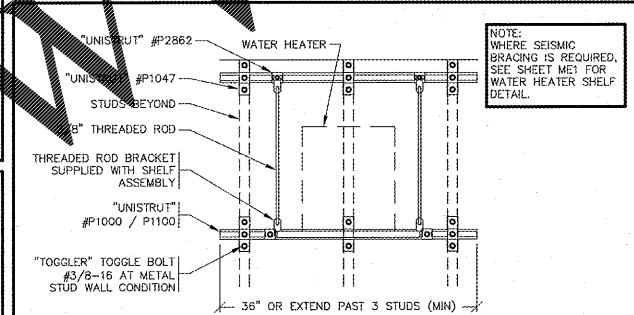
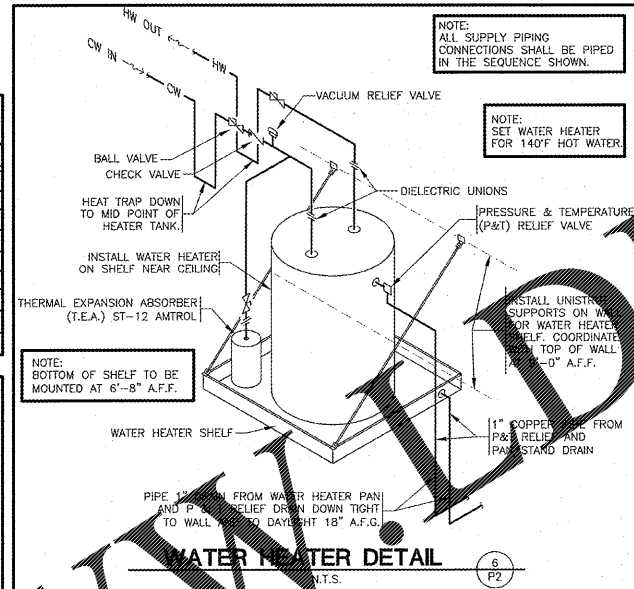
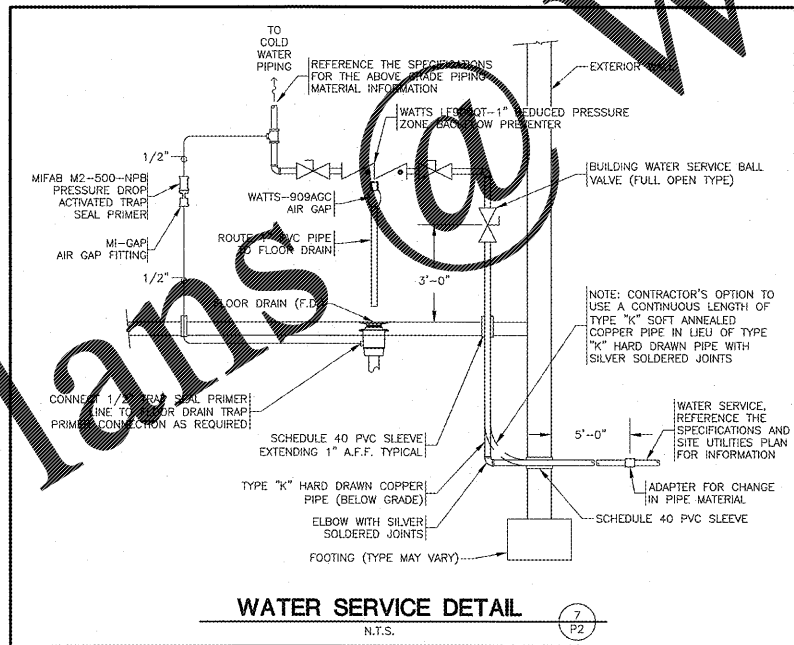
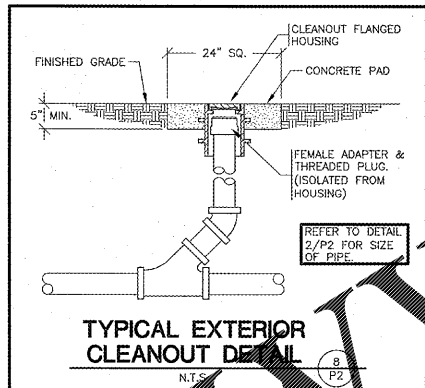

CRAIG A. SCHNEIDER, AIA
ARCHITECT
1736 East Sunshine, Suite 417
Springfield, Missouri 65804
417.962.0558
417.962.2265
e-mail: architect@estertstarchitect.com

PROJECT:
NEW O'REILLY AUTO PARTS STORE
HWY 67
PRICEVILLE, AL
PLUMBING DETAILS

O'Reilly AUTO PARTS
CORPORATE OFFICES
233 SOUTH PATTERSON
SPRINGFIELD, MISSOURI 65802
(417) 862-2674 TELEPHONE

COMM # 4160
DATE: 04-06-18
REVISION
DATE:

