

No.	Description	Date

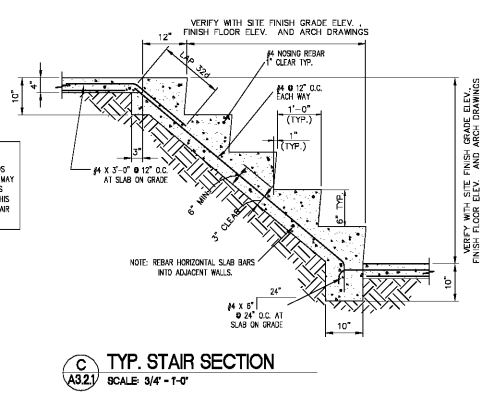
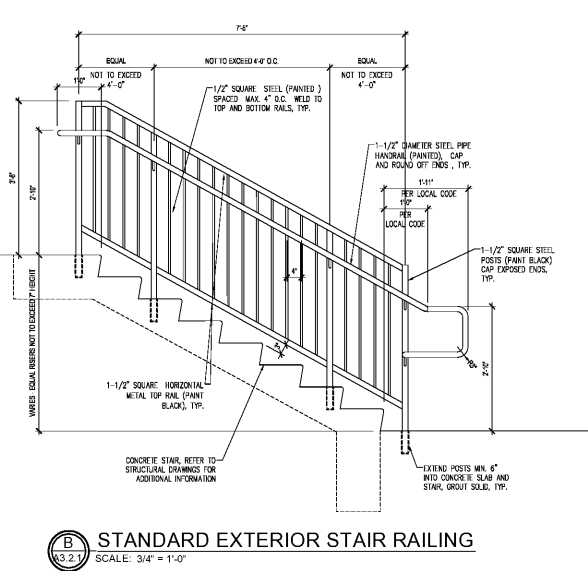
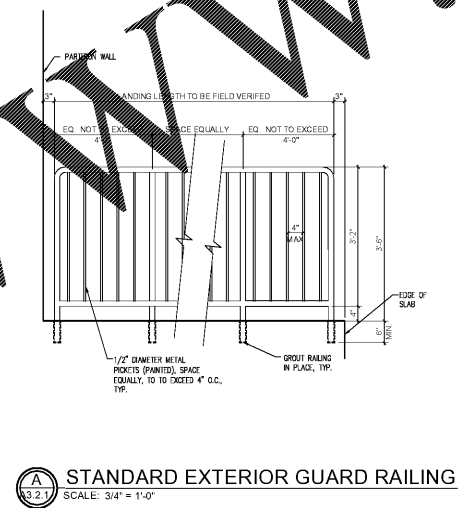
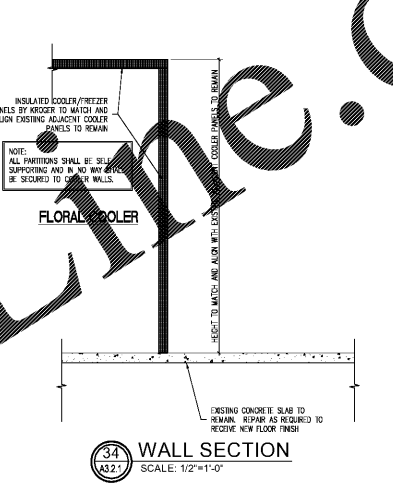
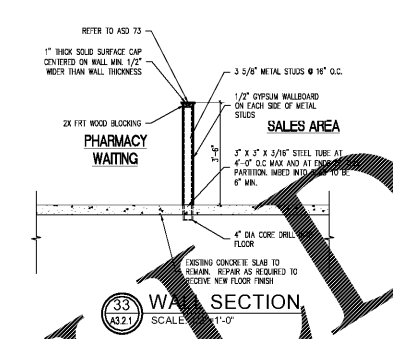
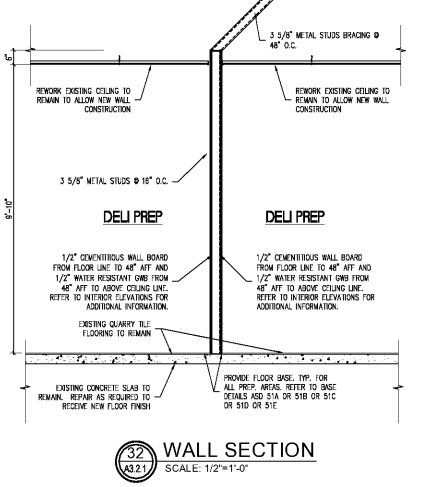
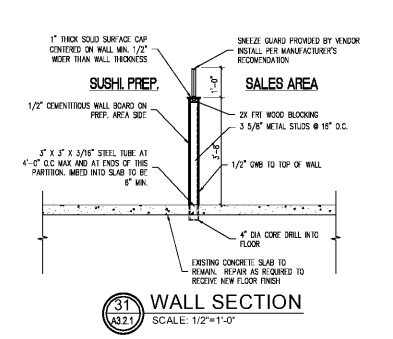
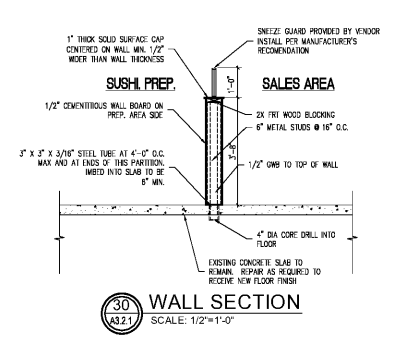

Order Plans @

WWW.LDILINE.COM