

- FAN #2 A2-G12-MPU - SUPPLY FAN
- 1. SUPPLY UNIT WITH 12" BLOWER IN SIZE #2 HOUSING
- 2. INTAKE HOOD WITH EZ FILTERS LOW CFM
- 3. DOWN DISCHARGE - AIR FLOW RIGHT -> LEFT
- 4. INSULATED BLOWER HOUSING SIZES 1-2 COMMERCIAL MODULAR
- 5. CONTROL PACKAGE FOR MOD PACKAGE UNIT COOLING ONLY UNIT INCLUDES AIRFLOW PROVING SWITCH, RTULINK-ACHP BOARD AND TERMINAL BLOCKS
- 6. 5 TON SINGLE CIRCUIT MODULAR PACKAGED COOLING OPTION FOR SIZE 2 MODULAR PACKAGED UNIT INCLUDES CONDENSER, DX COIL, FILTERDRYER KIT, THERMAL EXPANSION VALVE, R410A REFRIGERANT, AND REFRIGERANT PIPING (2,000 TO 3,000 CFM) NOT BUILT WITH OPPOSITE SIDE CONTROLS OR OPPOSITE AIRFLOW DIRECTION. CONDENSERS REQUIRE SEPARATE 200V, 3 PHASE POWER SUPPLY. COIL = 3E21001R
- 7. SUPPORT SHELL FOR SIZE 2 MODULAR PACKAGE UNIT INCLUDES CONTROL VES TIBULE INCLUDES CONDENSER SUPPORTS DOES NOT INCLUDE RETURN AIR OR INLET AIR DAMPER
- 8. SEPARATE 120VAC WIRING PACKAGE FOR MAKE UP AIR UNITS. OPTION MUST BE SELECTED WHEN MOUNTING VFD IN PREWIRE PANEL OR WITH DCV PACKAGE. PROVIDES SEPARATE 120VAC INPUT TO SUPPLY FAN. THIS 120V SIGNAL MUST BE RUN BY ELECTRICIAN FROM DCV TO MUA SWITCH.

NOTE: SUPPLY DUCT MUST BE INSTALLED TO MEET SMACNA STANDARDS, A MINIMUM STRAIGHT DUCT LENGTH EQUAL TO THREE TIMES THE SUPPLY DUCT EQUIVALENT DIAMETER MUST BE MAINTAINED DOWNSTREAM OF UNIT DISCHARGE UNLESS OTHERWISE SPECIFIED. DO NOT RELY ON UNIT TO SUPPORT DUCT IN ANY WAY.

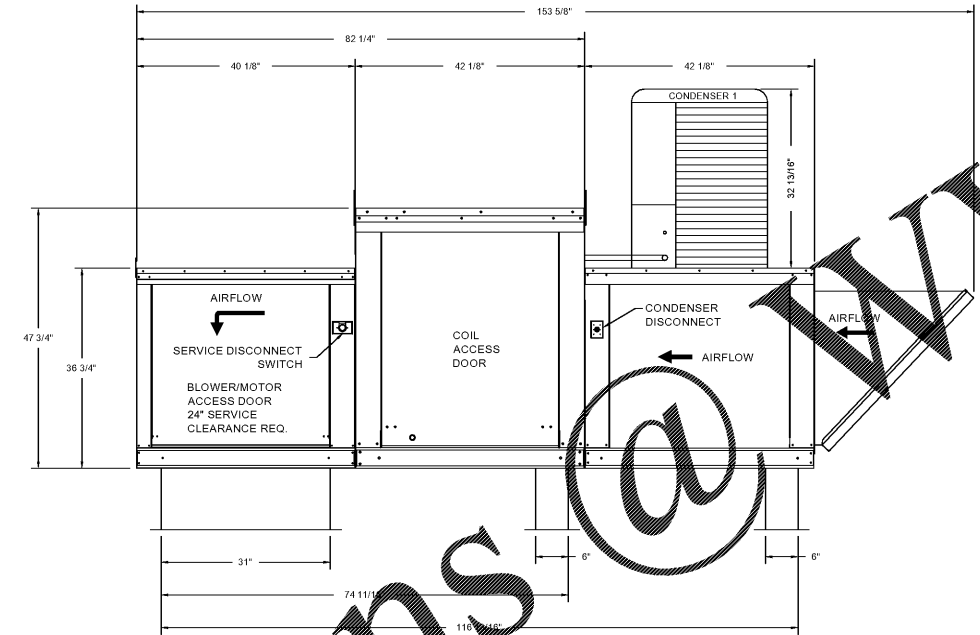

ROOF OPENING 2" SMALLER THAN CURB DIMENSION.

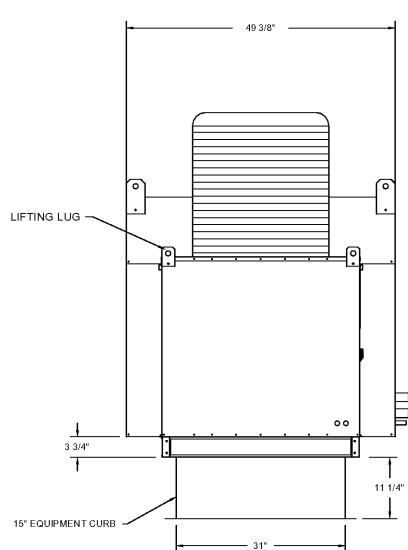
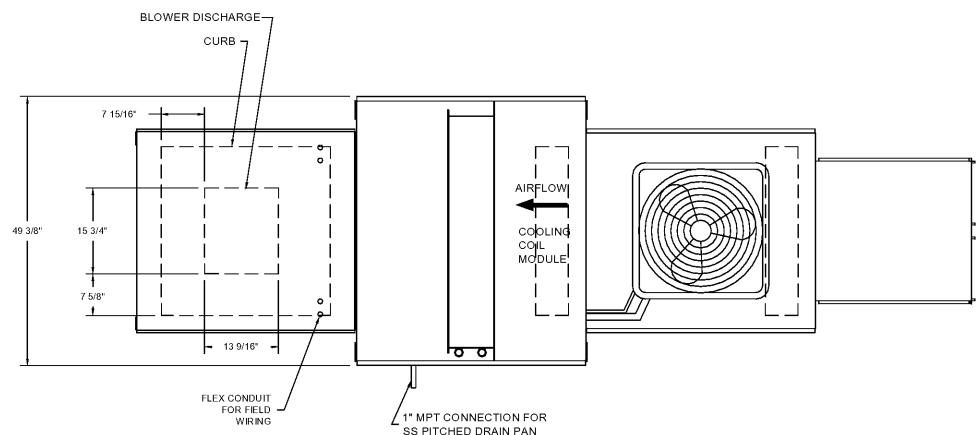
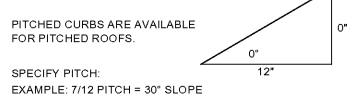

Typical Drain Trap Install

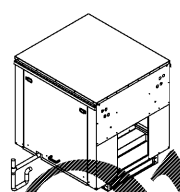

Recommended Cooling Coil Drain Trap Configuration

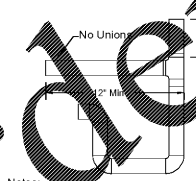

Notes:
 1) 1" diameter PVC Pipe only
 2) Use only low profile couplings
 3) Add clean out as shown

REVISIONS	
DESCRIPTION	DATE

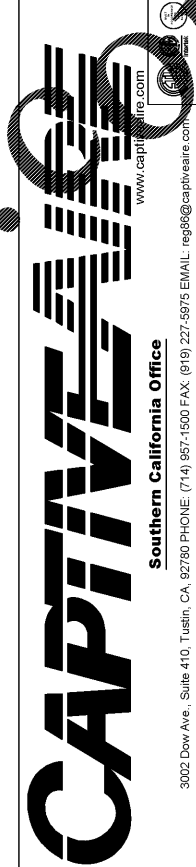

3002 Dow Ave., Suite 410, Tustin, CA, 92780 PHONE: (714) 957-1500 FAX: (919) 227-5975 EMAIL: reg88@captivair.com

Del Taco - Hiram GA
 4525 Jimmy Lee Smith Parkway,
 HIRAM, GA, 30141

DATE: 4/6/2018
 DWG.#: 3364331
 DRAWN BY: AHJ-86
 SCALE: 3/4" = 1'-0"
 MASTER DRAWING

SHEET NO.
 3

REVISIONS	NO
4/28/2018	
5/15/2018	

Del Taco - Hiram, GA 30141
 4525 Jimmy Lee Smith Pkwy
 DEL TACO

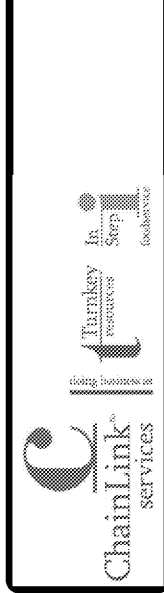

DRAWN:
 CHECKED:
 DATE: 4/5/2018
 SCALE:

K10
 SHEET

OF 11 SHEETS