

DRAWING INFORMATION		
DATE	DESCRIPTION	BY
05-13-18	FOR CONSTRUCTION	KM

N - C - A
CONSULTANTS / GROUP
4585 140TH AVE. NORTH, SUITE #1001
CLEARWATER, FLORIDA
PHONE: (877) 530-0078
CALL NCA MARKETING FOR PRICING
NCA JOB# 18-576

Shane R.
Hamilton PE
1717 Howard Avenue
Tomball, TX 77375
Tel: 281-330-0700 Fax: 281-684-1111

CHECKED BY: JMH, ENH
DATE: 05/22/18
REVISIONS:
NO. DATE DESCRIPTION & BID
RELEASED FOR CONSTRUCTION & BID



PREMIER KINGS, INC.
5529 CARMICHAEL ROAD
MONTGOMERY, ALABAMA 36117
PHONE: (205) 835-1111
LINDSEY@BURGERKING.COM

2126 Morris Avenue
Birmingham, AL 35203
Phone: (205) 322-1751
Fax: (205) 322-1778
email: info@hph.com
www.hph.com

James M. Hockett
architect AIA

SHANE R. HAMILTON
1717 HOWARD AVENUE, TOMBALL, TX 77375
GEORGIA LICENSE # 41331
No Penetration
G25118
HAMILTON

PROJECT # 16026.07
RUC-60 20/20 IMAGE APRIL 2015 DESIGN RELEASE
Burger King Restaurant
U.S. Hwy 278
Columbia, GA
EXHAUST DUCT INSTALLATION DETAILS

- A. COORDINATE WITH THE LATEST KITCHEN EQUIPMENT PLANS PRIOR TO INSTALLATION OF CURB. VERIFY WITH GENERAL CONTRACTOR.
- B. MARK AND PLUMBBOB THE LOCATION OF THE ROUND OPENING FROM FLOOR TO DECK.
- C. PLACE CURB OVER OPENING BY USING DIMENSION GIVEN BELOW.
- D. WHEN GREASE FLANGE ARRIVES PLACE ON CURB WITH ROUND OVER OPENING IN DECK.

HVAC CONTRACTOR SHALL NOT DISASSEMBLE THE EXHAUST FAN TO RECONFIGURE THE EXHAUST DISCHARGE

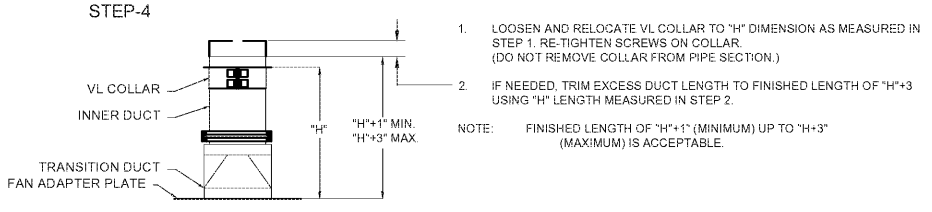
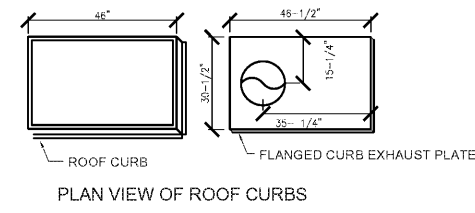

1. LOOSEN AND RELOCATE VL COLLAR TO "H" DIMENSION AS MEASURED IN STEP 1. RE-TIGHTEN SCREWS ON COLLAR. (DO NOT REMOVE COLLAR FROM PIPE SECTION.)
 2. IF NEEDED, TRIM EXCESS DUCT LENGTH TO FINISHED LENGTH OF "H"+3 USING "H" LENGTH MEASURED IN STEP 2.
- NOTE: FINISHED LENGTH OF "H"+1" (MINIMUM) UP TO "H"+3" (MAXIMUM) IS ACCEPTABLE.

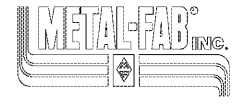
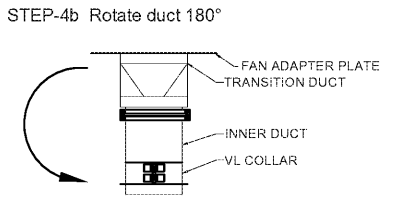

IPIC-3G Factory Built Case Duct
Installation Instructions
Specific for Burger King Restaurant Installation
(Fan Discharge Assembly)

Note: These instructions have been developed in coordination for use with kitchen exhaust hood manufactured by Gaylord Industries.

GFNFRAI INFORMATION

Metal-Fab IPIC-3G grease duct is "Listed" by Underwriters Laboratories for kitchen exhaust duct applications containing operation at 500° F and intermittent operation at 2000° F. IPIC-3G is further classified by Underwriters Laboratories as equivalent to a 2-hr. fire rated grease duct enclosure as per UL 21 test standard and for 7/8 inch clearance to combustibles for sizes up to and including 24-inch diameter.

Warning: During this installation, field application of factory-supplied insulation must be installed at joints and on variable length / adjustable length components. Do not substitute insulation with other makes or brands. After completion of installation, 2 layers of 1.5-inch insulation (supplied by manufacturer) must be applied directly around the inner duct as described in these instructions in order to maintain the 7/8-inch clearance to combustibles rating as per the manufacturer's UL listing.

FOR QUESTIONS CALL METAL-FAB @ 1-800-835-2830 X 4165

STEP-2 BROILER HOOD

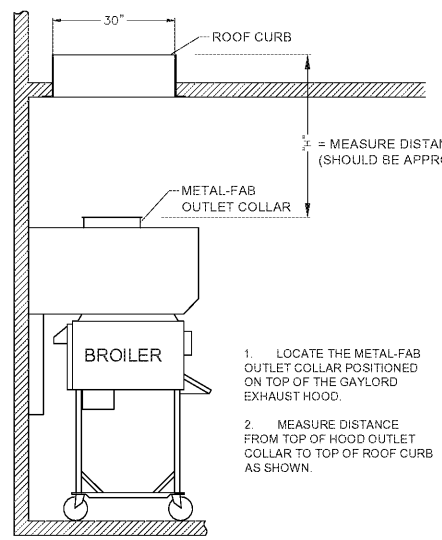

1. LOCATE THE METAL-FAB OUTLET COLLAR POSITIONED ON TOP OF THE GAYLORD EXHAUST HOOD.
2. MEASURE DISTANCE FROM TOP OF HOOD OUTLET COLLAR TO TOP OF ROOF CURB AS SHOWN.

STEP-2 (FRYER HOOD)

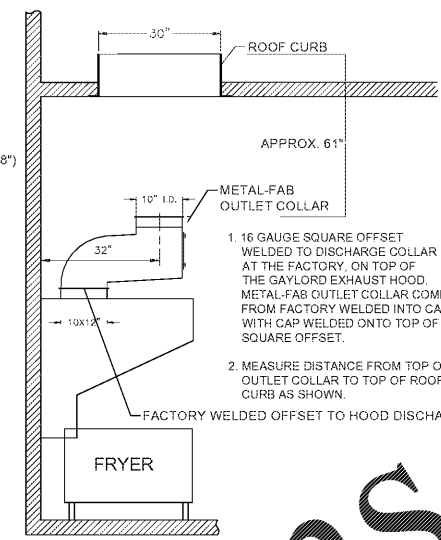

1. 16 GAUGE SQUARE OFFSET WELDED TO DISCHARGE COLLAR AT THE FACTORY. ON TOP OF THE GAYLORD EXHAUST HOOD. METAL-FAB OUTLET COLLAR COMES FROM FACTORY WELDED INTO CAP WITH CAP WELDED ONTO TOP OF SQUARE OFFSET.
2. MEASURE DISTANCE FROM TOP OF OUTLET COLLAR TO TOP OF ROOF CURB AS SHOWN.

STEP-5 (BROILER)

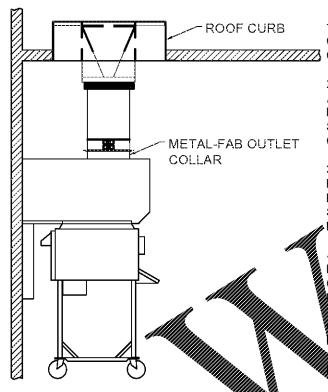

THE FOLLOWING INSTRUCTIONS ARE USED TO ALIGN THE GREASE DUCT TO THE HOOD OUTLET COLLAR.

1. TURN THE DUCT ASSEMBLY OVER & CAREFULLY SLIDE THROUGH THE FAN CURB.
2. CONTINUE LOWERING THE ASSEMBLY, AS IT APPROACHES THE HOOD, ALIGN THE OUTLET COLLAR. SLIP THE ASSEMBLY INTO THE COLLAR.
3. CHECK THE FAN ADAPTER PLATE FOR PROPER POSITION. THE OUTSIDE EDGE OF THE FAN ADAPTER PLATE SHOULD BE APPROXIMATELY 1" FROM EDGE OF ROOF CURB.
4. NOTE: IF THE FAN CURB IS NOT PROPERLY ALIGNED TO THE HOOD OUTLET COLLAR, THE FAN ADAPTER PLATE CAN BE TRIMMED TO RE-ALIGN.

STEP-5 (FRYER)

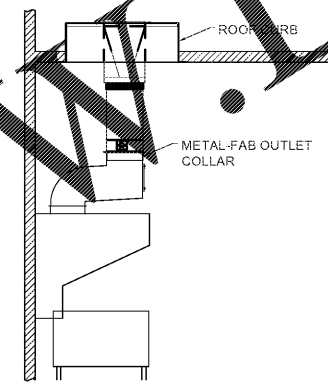

NOTE: ALL REMAINING INSTRUCTIONS PERTAIN TO BOTH BROILER EXHAUST HOOD AND FRYER EXHAUST HOOD, AS IN STEP-5.

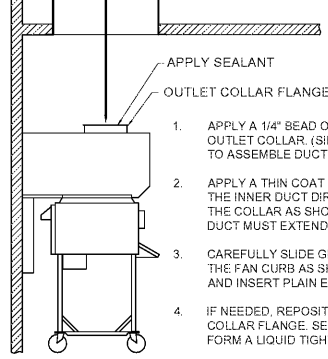
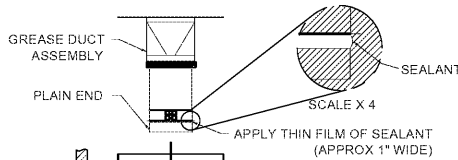

1. APPLY A 1/4" BEAD OF SEALANT ONTO THE FLANGE OF THE OUTLET COLLAR. (SIMILAR TO BEAD OF SEALANT USED TO ASSEMBLE DUCT SECTIONS IN STEP 3)
2. APPLY A THIN COAT OF SEALANT ABOUT 1" WIDE ON THE INNER DUCT DIRECTLY ABOVE THE FLANGE OF THE COLLAR AS SHOWN. (NOTE: PLAIN END OF THE INNER DUCT MUST EXTEND AT LEAST 1" PAST FLANGED COLLAR.)
3. CAREFULLY SLIDE GREASE DUCT ASSEMBLY THROUGH THE FAN CURB AS SHOWN. LOWER ASSEMBLY INTO BUILDING, AND INSERT PLAIN END INTO OUTLET COLLAR OF HOOD.
4. IF NEEDED, REPOSITION VL COLLAR UP AGAINST OUTLET COLLAR FLANGE. SEALANT SHOULD BE COMPRESSED TO FORM A LIQUID TIGHT SEAL.
5. SECURE DUCT ASSEMBLY TO FAN CURB USING TECH SCREWS (NOT SUPPLIED). IMPORTANT: RECTANGULAR PLATE OF DUCT ASSEMBLY MUST BE EVENLY CENTERED OVER FAN CURB. BEFORE SECURING TO FAN CURB, VERIFY THAT OUTER SURFACE OF GREASE DUCT MAINTAINS A MINIMUM 1-INCH CLEARANCE TO COMBUSTIBLE MATERIALS.
6. HVAC CONTRACTOR SHALL PROVIDE AND INSTALL HIGH TEMP SEALANT OR GASKET TO THE OUTER PERIMETER OF THE GREASE FLANGE.

STEP-7

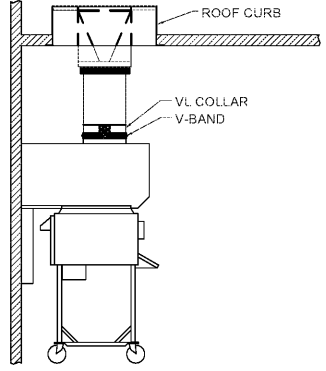

1. APPLY A BEAD OF SEALANT TO V-BAND CLAMP AND ATTACH TO JOINT AS SHOWN. REF. TO STEP 3.
2. TIGHTEN SCREWS ON VL COLLAR. (FOR MORE POSITIVE SEAL, APPLY SEALANT TO VL COLLAR SLOT AND FLARED OUT END OF COLLAR PRIOR TO TIGHTENING SCREWS.)

STEP-8

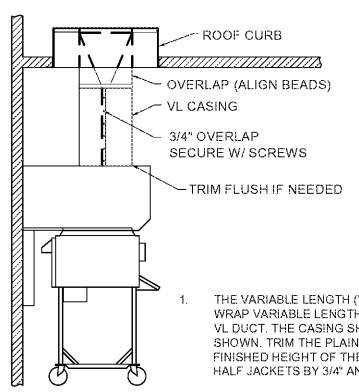

1. THE VARIABLE LENGTH (VL) CASING IS MADE UP OF (2) HALF-JACKETS. WRAP VARIABLE LENGTH (VL) CASING COMPLETELY AROUND THE INSULATED VL DUCT. THE CASING SHOULD OVERLAP THE DUCT ABOVE THE VL AS SHOWN. TRIM THE PLAIN END OF (VL) CASING SPACE IF NEEDED TO FIT THE FINISHED HEIGHT OF THE VARIABLE LENGTH (VL). OVERLAP SEAMS OF THE HALF JACKETS BY 3/4" AND SECURE USING SCREWS PROVIDED

© Copyright 2018- Drawings, specifications, notes, database, computer files, field data, and reports as instruments of service prepared by the Design of Record. As instruments of services, these items remain the property of the Design of Record, who shall retain all statutory and other reserved rights, including the copyright thereto. Any use, reproduction or changes to these documents without written consent of NCA Consultants is a violation of federal copyright laws.

Order Plans

STEP-3

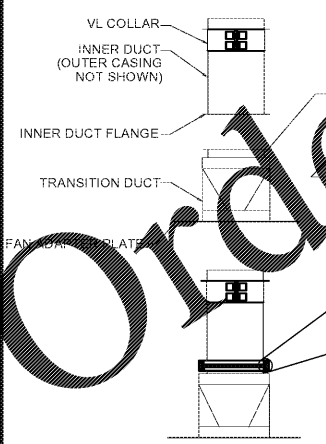

1. REMOVE THE OUTER CASING & INSULATION FROM THE VARIABLE LENGTH (VL) DUCT. (DO NOT DISCARD INSULATION OR CASING. IT WILL BE USED LATER.)
2. PLACE THE "TRANSITION DUCT WITH AN ADAPTER PLATE" UPSIDE DOWN ON THE DECK (FAN ADAPTER PLATE AGAINST ROOF).
3. APPLY BEAD OF SEALANT (PROVIDED) TO FLANGE.
4. APPLY SEALANT TO INSIDE GROOVE OF V-BAND. (V-BAND IS USED TO CLAMP INNER DUCT FLANGES TOGETHER.)
5. SET INNER DUCT FLANGE ON TRANSITION DUCT FLANGE.

1. ATTACH THE V-BAND CLAMP OVER THE INNER DUCT FLANGES.
- NOTE: WHEN ATTACHING CLAMP BAND USE A RUBBER Mallet (OR OTHER) TO AID IN ASSEMBLY. TIGHTEN V-BAND CLAMP USING HEX DRIVE SCREWS PROVIDED TO COMPLETE A LIQUID TIGHT SEAL.